



**Catalogo / Catalogue 2018**

---

### Ottone / Brass

---

<b>Indice generale della serie Rosetta Fine / General index of the Slim Rosette series</b>	<b>pag</b>	<b>5</b>
<b>Legenda codici di identificazione articoli / Legend of articles identification codes</b>	<b>pag</b>	<b>6</b>
<b>Sistemi di fissaggio / Fixing versions available</b>	<b>pag</b>	<b>8</b>
<b>Certificazione e Qualità / Quality Certifications</b>	<b>pag</b>	<b>9</b>
<b>Certificazione Classe 4 / Class 4 Certification</b>	<b>pag</b>	<b>10</b>
<b>Legenda finiture / Finish options</b>	<b>pag</b>	<b>12</b>
<b>Zirtanio: trattamento protettivo ad alta resistenza / Zirtanio: high grade protective coating PVD</b>	<b>pag</b>	<b>13</b>
<b>Indice generale delle serie / General series index</b>	<b>pag</b>	<b>14</b>
<b>Indice dei designers / Designers index</b>	<b>pag</b>	<b>17</b>
<b>Catalogo prodotto / Product Catalogue</b>	<b>pag</b>	<b>18</b>
<b>Legenda Maniglie in Ottone Patrimonio senza tempo / Timeless Heritage collection / Brass door handles</b>	<b>pag</b>	<b>232</b>
<b>Il nostro patrimonio senza tempo / Our heritage timeless</b>	<b>pag</b>	<b>234</b>

---

### Inox / Stainless steel

---

<b>Legenda codici di identificazione articoli / Legend of articles identification codes</b>	<b>pag</b>	<b>254</b>
<b>Indice generale delle serie / General series index</b>	<b>pag</b>	<b>16</b>
<b>Indice dei designers / Designers index</b>	<b>pag</b>	<b>17</b>
<b>Catalogo prodotto / Product Catalogue</b>	<b>pag</b>	<b>256</b>
<b>Informazioni tecniche / Technical informations</b>	<b>pag</b>	<b>279</b>
<b>Informazioni tecniche speciali / Special technical specifications</b>	<b>pag</b>	<b>291</b>

---

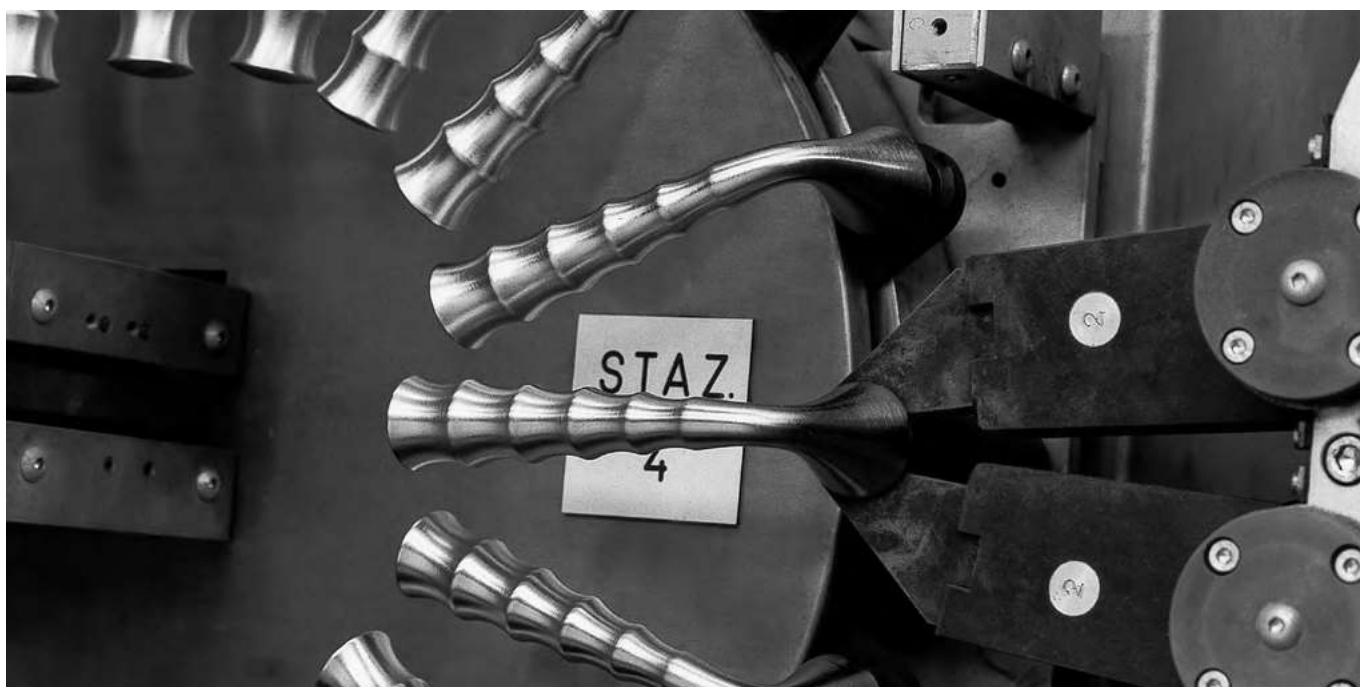
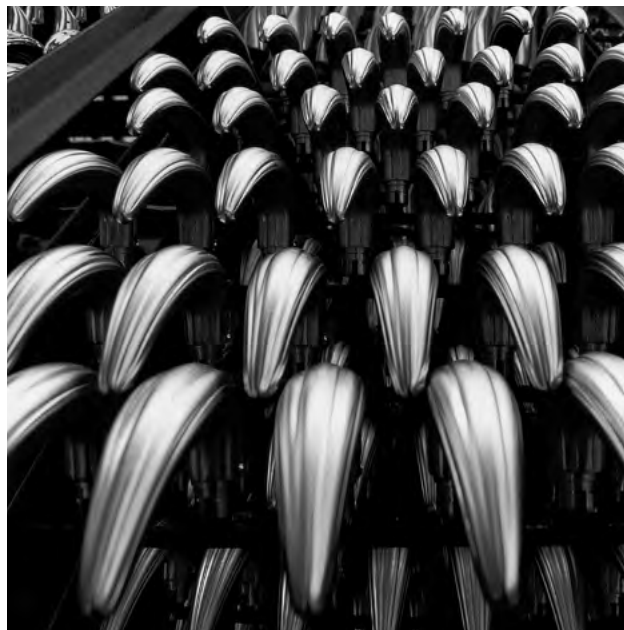

È un approccio quasi sartoriale a contraddistinguere la produzione di Valli&Valli, la storica azienda di Renate appartenente al gruppo ASSA ABLOY.

Grazie all'esperienza che solo una realtà con oltre ottant'anni di storia può garantire, Valli&Valli è in grado di proporre linee di prodotti sempre innovative che alimentano con eleganza la sua offerta.

È l'industrializzazione che si sposa con il lusso della personalizzazione, per una proposta sempre di più 'su misura'. Un percorso innovativo: maniglie di concezione totalmente industriale e prodotte con un processo rivoluzionario di ingegnerizzazione, che possono al contempo essere declinate in infinite personalizzazioni, rispondendo alle esigenze specifiche dei clienti.

Oggi, il DNA tecnologico di Valli&Valli viene applicato alla profondità di gamma, alle finiture e alle personalizzazioni, per una casa che è sempre più ricercata a nostra misura.

Scopri la vasta gamma di maniglie e finiture visitando [www.vallievalli.com](http://www.vallievalli.com)





# Rosetta fine / Slim Rosette

Rosetta fine (50 x 5 mm) applicabile alle serie descritte:

(50 x 5 mm) slim rosette applicable to the following series:

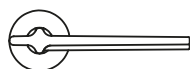

**H 378**  
Serie YP Duemiladicotto  
design Yabu Pushelberg

Pag. 227

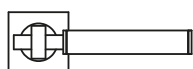

**H 377**  
Serie SL Duemilasedici  
design Steve Leung

Pag. 159



**H 375**  
Serie MT Duemilaquattordici  
design Marco Triaca

Pag. 209



**H 372**  
Serie EG Duemilaundici  
design Eri Goshen

Pag. 131



**H 370**  
Serie MDF Duemiladieci  
design Doriana e Massimiliano Fuksas

Pag. 119



**H 368**  
Serie CA Duemilanove  
design Cerri&Associati

Pag. 51



**H 367**  
Serie GV Duemilanove  
design Giancarlo Vegni

Pag. 221

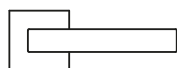

**H 364**  
Serie MB Duemilanove  
design Mario Bellini

Pag. 21

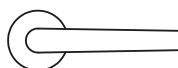

**H 362**  
Serie CC Duemilanove  
design Carlo Colombo

Pag. 97



**H 361**  
Serie AC4 Duemilasei  
design Antonio Citterio

Pag. 77

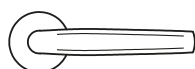

**H 359** Serie SOM  
New York Duemilasette  
design Skidmore, Owings & Merrill

Pag. 197



**H 358**  
Serie JP1 Duemila  
design John Pawson

Pag. 179



**H 356**  
Serie ZH Duemilacinque  
design Zaha Hadid

Pag. 141

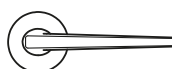

**H 348**  
Serie DC Duemiladue  
design David Chipperfield Architects

Pag. 71

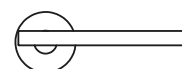

**H 343**  
Serie JP Duemila  
design John Pawson

Pag. 183

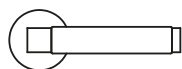

**H 341**  
Serie HK2 Duemila  
design Hans Kollhoff

Pag. 147



**H 338**  
Serie YK Duemila  
design Yoshimi Kono

Pag. 153

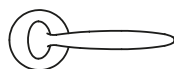

**H 330**  
Serie T Novantasette  
design Matteo Thun

Pag. 203

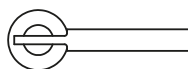

**H 329**  
Serie RB Novantacinque  
design Taller Design Ricardo Bofill

Pag. 37

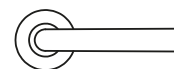

**H 327** Serie  
AC 2 Novantacinque  
design Antonio Citterio

Pag. 83



**H 326**  
Serie AC1 Novantacinque  
design Antonio Citterio

Pag. 87



**H 317**  
Serie AC Novantuno  
design Antonio Citterio

Pag. 91



**H 315**  
Serie G Novanta  
design Pierluigi Cerri

Pag. 61

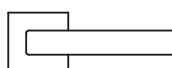

**H 311**  
Serie Sei MB  
design Mario Bellini

Pag. 25



**H 310**  
Serie Cinque C  
design Achille Castiglioni

Pag. 45

Composizione codice prodotto / Composition of product code

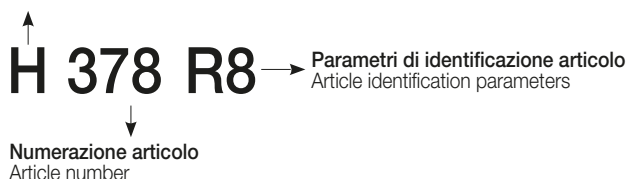
 Identificazione tipologia prodotto  
 Product type identification

<b>H</b>	<b>Maniglie per porta e per finestra / Door handles and window handles</b>
<b>K</b>	<b>Pomoli per porta / Door knobs</b> <b>Maniglioni / Pull handles</b> <b>Bocchette / Escutcheons</b> <b>Chiusure privacy BZG / Bathroom privacy sets</b>
<b>M</b>	<b>Chiavi per porta / Door keys</b>
<b>E</b>	<b>Portabiti / Coat-hooks</b> <b>Ganci / Hooks</b>
<b>X</b>	<b>Complementari e sistemi di fissaggio</b> Complementary accessories and fixing systems

## Descrizione parametri di identificazione articolo / Description of article identification parameters

...R..		<b>Articolo con rosetta, molla di ritorno e sottorosea con viti a legno, quadro 7 o 8 mm, bocchetta con foro chiave normale.</b> Article on rosette with return spring and anchor rose with wooden screws, 7 or 8 mm spindle, with standard escutcheon.
...RB..		<b>Articolo con rosetta fine, molla di ritorno e sottorosea con viti a legno, quadro 7 o 8 mm, bocchetta fine con foro chiave normale.</b> Article on slim rosette with return spring and anchor rose with wooden screws, 7 or 8 mm spindle, with standard slim escutcheon.
...R .. Y		<b>Articolo con rosetta, molla di ritorno, sottorosea con viti a legno, quadro 7 o 8 mm, bocchetta con foro chiave cilindro.</b> Article on rosette with return spring and anchor rose with wooden screws, 7 or 8 mm spindle, with cylinder escutcheon.
...RB..Y		<b>Articolo con rosetta fine, molla di ritorno e sottorosea con viti a legno, quadro 7 o 8 mm, bocchetta fine con foro chiave cilindro.</b> Article on slim rosette with return spring and anchor rose with wooden screws, 7 or 8 mm spindle, with cylinder slim escutcheon.
...RO8..		<b>Articolo con rosetta stretta, molla di ritorno e sottorosea con viti a legno, quadro 8 mm, bocchetta stretta con foro chiave normale.</b> Article on narrow rose, with return spring, anchor rose with wooden screw, 8 mm spindle narrow escutcheon with normal key hole.
...RO8 .. Y		<b>Articolo con rosetta stretta, molla di ritorno e sottorosea con viti a legno, quadro 8 mm, bocchetta stretta con foro chiave cilindro.</b> Article on narrow rose, with return spring, anchor rose with wooden screw, 8 mm spindle narrow escutcheon with cylinder key hole.
...RG..		<b>Articolo con rosetta, molla di ritorno, sottorosea con perni per viti passanti, quadro 8 o 8.5 mm, bocchetta con foro chiave.</b> Article on rosette with return spring and anchor rose for bolt through fixing, 8 or 8,5 mm spindle, with standard escutcheon.
...RGB..		<b>Articolo con rosetta fine, molla di ritorno, sottorosea con perni per viti passanti, quadro 8 o 8.5 mm, bocchetta fine con foro chiave normale.</b> Article on slim rosette with return spring and anchor rose for bolt through fixing, 8 or 8,5 mm spindle, with standard slim escutcheon.
...RG .. Y		<b>Articolo con rosetta, molla di ritorno, sottorosea con perni per viti passanti, quadro 8 o 8,5 mm, bocchetta con foro chiave cilindro.</b> Article on rosette with return spring and anchor rose for bolt through fixing, 8 or 8,5 mm spindle, with cylinder escutcheon.
...RGB..Y		<b>Articolo con rosetta fine, molla di ritorno, sottorosea con perni per viti passanti, quadro 8 o 8,5 mm, bocchetta fine con foro chiave cilindro.</b> Article on slim rosette with return spring and anchor rose for bolt through fixing, 8 or 8,5 mm spindle, with cylinder slim escutcheon.

## Legenda codici di identificazione articoli / Article identification codes

...P .. 70\*



Articolo con placca, quadro 7-8-8.5 mm, foro chiave normale. Il numero 70, indicato a titolo di esempio, che è variabile e dipende dalle normative di ogni mercato, indica l'interasse in mm tra foro chiave e foro maniglia.

Article on plate, 7-8-8,5 mm spindle, standard keyhole. The number "70" shown is variable and depends on the requirements of each individual market. It indicates distance between the spindle and keyhole centre in mm.

...P .. Y 85\*



Articolo con placca, quadro 7-8-8.5 mm, foro chiave cilindro. Il numero 85, indicato a titolo di esempio, che è variabile e dipende dalle normative di ogni mercato, indica l'interasse in mm tra foro chiave e foro maniglia.

Article on plate, 7-8-8,5 mm spindle, cylinder keyhole. The number "85" shown is variable and depends on the requirements of each individual market. It indicates distance between the spindle and keyhole centre in mm.

...F



Maniglia per finestra  
Window handle.

...F RS



Maniglia per finestra con movimento DRY-KEEP 4 e/o 8 scatti, disponibile con lunghezza quadro 27-30-35-41-45-50 mm.  
Window handle with DRY-KEEP movement, 4/8 click positions, available with spindle lengths 27-30-35-41-45-50 mm.

...F RS B



Maniglia per finestra con movimento DRY-KEEP 8 scatti, su rosetta fine disponibile con lunghezza 41 mm.  
Window handle with DRY-KEEP movement, 8 click positions on slim rosette, available with 41 mm spindle length.

...F RS B...S

Maniglia per finestra con movimento DRY-KEEP 8 scatti provvisto di pulsante di sicurezza, su rosetta fine disponibile con lunghezza 41 mm.  
Window handle with DRY-KEEP movement, 8 click positions, with safety devise, on slim rosette, available with 41 mms spindle length.

...R 6-7-8  
BZG

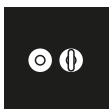

Chiusura privacy, quadro disponibile 6-7-8 mm e lunghezza 75-85 mm, sottorosetta con viti a legno.  
Bathroom privacy set, 6-7-8 mm diameter spindle with length of 75-85 mm. Anchor rose with wood screws.

...RG 6-7-8  
BZG

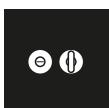

Chiusura privacy, quadro disponibile 6-7-8 mm e lunghezza 75-85 mm, sottorosetta con viti passanti.  
Bathroom privacy set, 6-7-8 mm diameter spindle with length of 75-85 mm. Anchor rose with through screws.

...RS 6-7-8  
BZG



Chiusura privacy, quadro disponibile 6-7-8 mm e lunghezza 75-85 mm, sottorosetta con viti a legno, con indicatore libero/occupato.  
Bathroom privacy set, 6-7-8 mm diameter spindle with length of 75-85 mm. Anchor rose with wood screws. Vacant/engaged indicator.

...RSG 6-7-8  
BZG



Chiusura privacy, quadro disponibile 6-7-8 mm e lunghezza 75-85 mm, sottorosetta con viti passanti, con indicatore libero/occupato.  
Bathroom privacy set, 6-7-8 mm diameter spindle with length of 75-85 mm. Anchor rose with through screws. Vacant/engaged indicator.

...GL



Maniglia per serratura porte vetro.  
Door handle suitable for glass door locks.

Per le versioni disponibili fare riferimento al listino-prezzi in vigore nel paese di appartenenza  
To see the available versions, please refer to the price-list in force in each Country



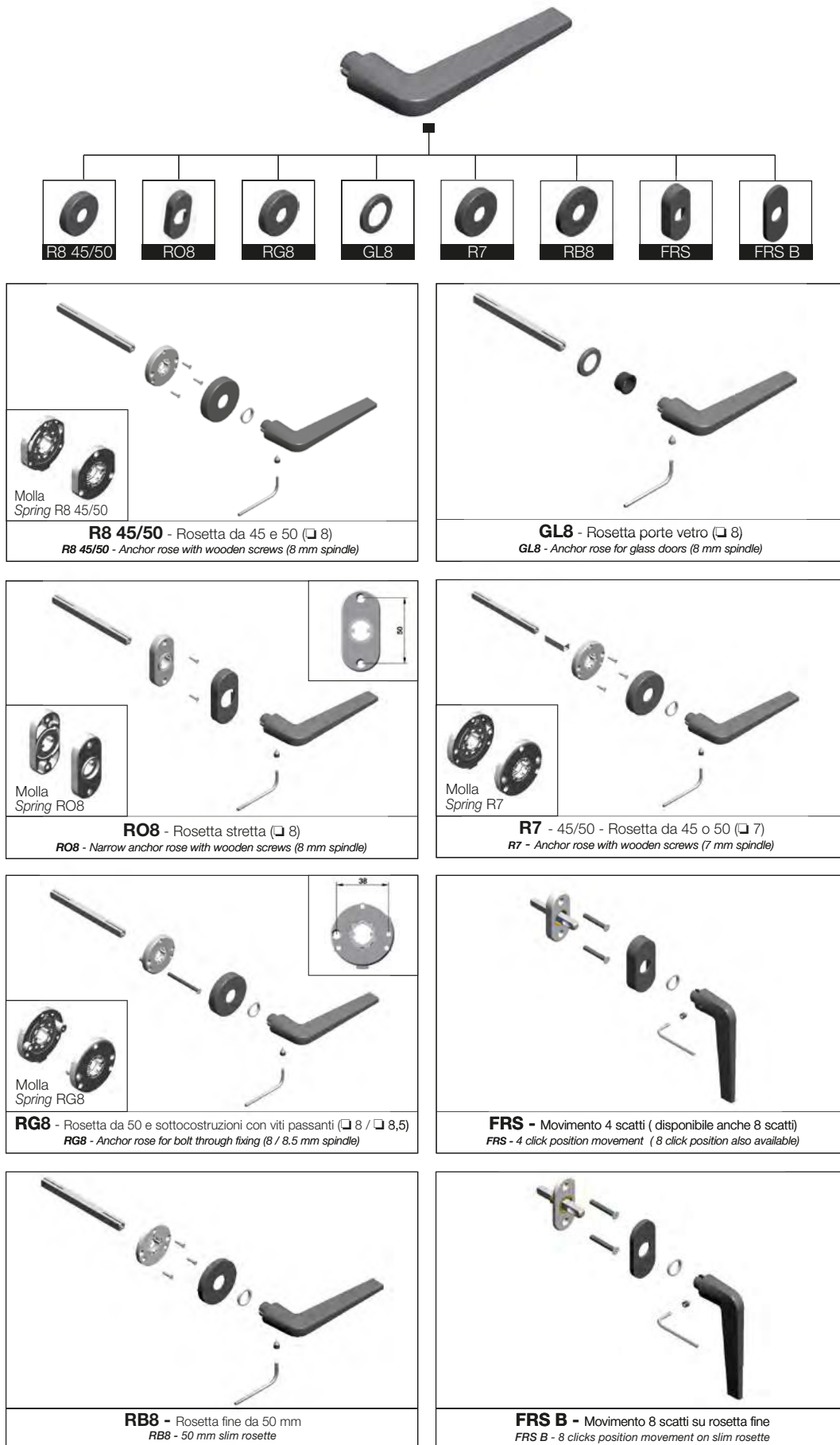



CERTIFICATO n. **0689A/1**  
CERTIFICATE No.

SI CERTIFICA CHE IL SISTEMA DI GESTIONE AMBIENTALE DI  
WE HEREBY CERTIFY THAT THE ENVIRONMENTAL MANAGEMENT SYSTEM OPERATED BY

**ASSA ABLOY ITALIA S.P.A.**  
Sede e Unità Operativa

Via Bovaresa, 13 - 40017 San Giovanni in Persiceto (BO) - Italia  
Progettazione, produzione, di serrature meccaniche, elettriche ed elettroniche, chiavi, cilindri, chiusure mediante processi di lavorazioni meccaniche, trattamenti termici, galvanici, in relativo assemblaggio. Vendita di chiavi e cilindri.

Unità Operativa  
Via Concordia, 16 - 20838 Renate (MB) - Italia  
Progettazione e produzione di maniglie e coordinati per l'arredamento mediante lavorazioni di stampaggio a caldo, smerigliatura, vibratura, pfultura, verniciatura, trattamenti galvanici.

Via Leonardo da Vinci, 1/3 - 29016 Cortemaggiore (PC) - Italia  
Progettazione, produzione e assistenza di porte blindate e porte tagliafuoco mediante processi di lavorazione meccanica, saldatura, verniciatura, assemblaggio e collaudo. Progettazione e produzione di serrature meccaniche, elettriche ed elettroniche, chiavi, cilindri, lucchetti e accessori in alluminio e acciaio inossidabile. Progettazione e produzione di serrature meccaniche, elettriche ed elettroniche, chiavi, cilindri, lucchetti e accessori in alluminio e acciaio inossidabile. Progettazione e produzione di serrature meccaniche, elettriche ed elettroniche, chiavi, cilindri, lucchetti e accessori in alluminio e acciaio inossidabile. Progettazione e produzione di serrature meccaniche, elettriche ed elettroniche, chiavi, cilindri, lucchetti e accessori in alluminio e acciaio inossidabile.

E' CONFORME ALLA NORMA  
IS IN COMPLIANCE WITH THE STANDARD  
**UNI EN ISO 14001:2015**  
PER LE SEGUENTI ATTIVITA'  
FOR THE FOLLOWING ACTIVITIES  
**EA: 17**

Progettazione e produzione di serrature meccaniche, elettriche ed elettroniche, chiavi, cilindri, lucchetti e accessori in alluminio e acciaio inossidabile. Progettazione e produzione di serrature meccaniche, elettriche ed elettroniche, chiavi, cilindri, lucchetti e accessori in alluminio e acciaio inossidabile. Progettazione e produzione di serrature meccaniche, elettriche ed elettroniche, chiavi, cilindri, lucchetti e accessori in alluminio e acciaio inossidabile. Progettazione e produzione di serrature meccaniche, elettriche ed elettroniche, chiavi, cilindri, lucchetti e accessori in alluminio e acciaio inossidabile.

04/09/2014



04/09/2014



CERTIFICATO n. **0492/7**  
CERTIFICATE No.

SI CERTIFICA CHE IL SISTEMA DI GESTIONE PER LA QUALITA' DI  
WE HEREBY CERTIFY THAT THE QUALITY MANAGEMENT SYSTEM OPERATED BY

**ASSA ABLOY ITALIA S.P.A.**  
Sede e Unità Operativa

Via Bovaresa, 13 - 40017 San Giovanni in Persiceto (BO) - Italia  
Uffici direzionali, progettazione, produzione, vendita e commercializzazione di serrature meccaniche, elettriche ed elettroniche, chiavi, cilindri, lucchetti, maniglie antipanico e chiudiporta.

Unità Operativa  
Via Concordia, 16 - 20838 Renate (MB) - Italia  
Progettazione, produzione e vendita di maniglie e coordinati per l'arredamento.

Via Salvatore Quasimodo, 136 - 00144 Roma (RM) - Italia  
Uffici commerciali.

Via Leonardo da Vinci, 1/3 - 29016 Cortemaggiore (PC) - Italia  
Progettazione, produzione e vendita di porte blindate e di avvolgibili in alluminio e acciaio inossidabile.

E' CONFORME ALLA NORMA  
IS IN COMPLIANCE WITH THE STANDARD  
**UNI EN ISO 9001:2015**  
PER LE SEGUENTI ATTIVITA'  
FOR THE FOLLOWING ACTIVITIES  
**EA: 17 - 23**

Progettazione, produzione, vendita e commercializzazione di serrature meccaniche, elettriche ed elettroniche, chiavi, cilindri, lucchetti, maniglie antipanico e chiudiporta. Progettazione e produzione di maniglie e coordinati per l'arredamento. Progettazione, produzione e assistenza di serrature meccaniche, elettriche ed elettroniche, chiavi, cilindri, lucchetti, maniglie antipanico e chiudiporta. Progettazione e produzione di maniglie e coordinati per l'arredamento. Progettazione, produzione e assistenza di serrature meccaniche, elettriche ed elettroniche, chiavi, cilindri, lucchetti, maniglie antipanico e chiudiporta. Progettazione e produzione di maniglie e coordinati per l'arredamento. Progettazione, produzione e assistenza di serrature meccaniche, elettriche ed elettroniche, chiavi, cilindri, lucchetti, maniglie antipanico e chiudiporta. Progettazione e produzione di maniglie e coordinati per l'arredamento.

04/07/2017



04/07/2017



Certificazione di Prodotto  
Product Certification

Certificato N. **ICIM-MNL-000001-00**  
Certificate No.

ALL'AZIENDA / TO THE FIRM  
**ASSA ABLOY ITALIA S.p.A.**  
Via Bovaresa, 13  
10017 San Giovanni in Persiceto (BO) - IT  
UNITA' OPERATIVE / OPERATIVES UNITS  
Valli&Valli Business Unit  
Via Concordia 16 - 20838 Renate (MB) - IT  
PER I SEGUENTI PRODOTTI / FOR THE FOLLOWING PRODUCTS  
**MANIGLIE E POMOLI  
LEVER HANDLES AND KNOB FURNITURE**

CON DENOMINAZIONE COMMERCIALE / WITH TRADE NAME/S  
Brand: Valli & Valli

Modelli / Models:	H 1022 R8 <sup>®</sup> CL4 ; H 1022 R8B <sup>®</sup> CL4 H 1027 R8 <sup>®</sup> CL4 ; H 1027 R8B <sup>®</sup> CL4 H 1039 R8 <sup>®</sup> CL4 ; H 1039 R8B <sup>®</sup> CL4 H 1045 R8 <sup>®</sup> CL4 ; H 1045 R8B <sup>®</sup> CL4 H 1049 R8 <sup>®</sup> CL4 ; H 1049 R8B <sup>®</sup> CL4 H 1052 R8 <sup>®</sup> CL4 ; H 1052 R8B <sup>®</sup> CL4	H 165 R8 <sup>®</sup> CL4 ; H 165 R8B <sup>®</sup> CL4 ; H 338 R8 <sup>®</sup> CL4 ; H 338 R8B <sup>®</sup> CL4 ; H 354 R8 <sup>®</sup> CL4 ; H 354 R8B <sup>®</sup> CL4 ; H 370 R8 <sup>®</sup> CL4 ; H 370 R8B <sup>®</sup> CL4 ; H 317 R8 <sup>®</sup> CL4 ; H 317 R8B <sup>®</sup> CL4 ;
-------------------	--	--

Materiali / Materials: Ottone / Brass  
Finitura / Finish: Cromo / Chrome  
Cromo Satinato / Satin Chrome

\* can be empty or with digit identifying cylinder cutback type  
CONFORMEMENTE ALLA NORMA ED AL DOCUMENTO NORMATIVO ICIM  
IN COMPLIANCE WITH THE STANDARD AND WITH ICIM NORMATIVE DOCUMENT  
**EN 1906:2012 - ICIM 0414CS**

CON CLASSIFICAZIONE / WITH CLASSIFICATION  
**4 7 - 0 0 4 0 B**

**ICIM S.p.A.**

PRIMA EMISSIONE FIRST ISSUE	EMISSIONE CORRENTE CURRENT ISSUE	DATA DI SCADENZA EXPIRING DATE
14/02/2017	04/08/2017	13/02/2020

ASSA ABLOY / Valli&Valli ha ottenuto le certificazioni / ASSA ABLOY /Valli&Valli has obtained the certifications:

- Norma Europea EN 1906:2012 / European Norm EN 1906:2012
- Sistema di Gestione Ambientale ai sensi della Norma UNI EN ISO 14001:2015 / Environmental Management according to UNI EN ISO 14001:2015
- Sistema di Gestione Qualità ai sensi della Norma UNI EN ISO 9001:2015 / Quality Management according to UNI EN ISO 9001:2015



**H 376**  
Serie GV Duemilaquattordici  
design Giancarlo Vegni

Pag. 217

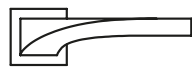

**H 372**  
Serie EG Duemilaundici  
design Eri Goshen

Pag. 131

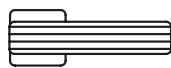

**H 370**  
Serie MDF Duemiladieci  
design Doriana e Massimiliano Fuksas

Pag. 119

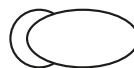

**H 368**  
Serie CA Duemilanove  
design Cerri&Associati

Pag. 51



**H 367**  
Serie GV Duemilanove  
design Giancarlo Vegni

Pag. 221

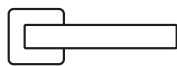

**H 364**  
Serie MB Duemilanove  
design Mario Bellini

Pag. 21

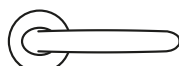

**H 363**  
Serie DC Duemilanove  
design David Chipperfield

Pag. 67



**H 362**  
Serie CC Duemilanove  
design Carlo Colombo

Pag. 97

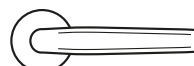

**H 359 Serie SOM**  
New York Duemilasette  
design Skidmore, Owings & Merrill

Pag. 197



**H 354**  
Serie FOG Duemilaquattro  
design Frank O. Gehry

Pag. 125

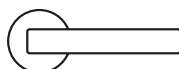

**H 350**  
Serie CA Duemiladue  
design Cerri & Associati

Pag. 55



**H 348**  
Serie DC Duemiladue  
design David Chipperfield Architects

Pag. 71



**H 338**  
Serie YK Duemila  
design Yoshimi Kono

Pag. 153



**H 334**  
Serie NF Novantotto  
design Foster and Partners

Pag. 111



**H 330**  
Serie T Novantasette  
design Matteo Thun

Pag. 203

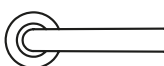

**H 327**  
Serie AC 2 Novantacinque  
design Antonio Citterio

Pag. 83



**H 326**  
Serie AC1 Novantacinque  
design Antonio Citterio

Pag. 87



**H 317**  
Serie AC Novantuno  
design Antonio Citterio

Pag. 91

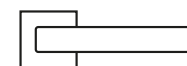

**H 311**  
Serie Sei MB  
design Mario Bellini

Pag. 25

# Norma Europea EN 1906:2012

## European Norm EN 1906:2012



Descrizione Description	Classe Class	Significato delle classi Class meaning													
<b>1</b> Categoria di utilizzo Category of use	1 2 3 4	<p><b>Classe 1</b> Utilizzo di media frequenza delle guarniture, da parte di persone che sostanzialmente esercitano un utilizzo accurato e presentano un rischio ridotto per quanto riguarda l'uso non corretto (ad esempio per le porte interne di abitazioni). <i>Medium frequency of use by people with a high incentive to exercise care and with a small chance of misuse, e.g. internal residential doors.</i></p> <p><b>Classe 2</b> Utilizzo di media frequenza delle guarniture, da parte di persone che esercitano un utilizzo sostanzialmente accurato ma che presentano un certo rischio per quanto riguarda l'uso non corretto (ad esempio per le porte interne di uffici). <i>Medium frequency of use by people with some incentive to exercise care but where there is some chance of misuse, e.g. internal office doors.</i></p> <p><b>Classe 3</b> Utilizzo ad elevata frequenza delle guarniture, da parte del pubblico o di altre persone, che non hanno particolare cura nell'uso e per le quali esiste un notevole rischio d'utilizzo errato (ad esempio per le porte di edifici pubblici notevolmente frequentati). <i>High frequency of use by public or others with little incentive to exercise care and with a high chance of misuse, e.g. public office doors.</i></p> <p><b>Classe 4</b> Per impiego su porte che vengono azionate spesso e con forza (porte in stadi da calcio, su piattaforme petrolifere, nelle caserme, toilette pubbliche, ...). <i>High frequency of use on doors which are subject to frequent violent usage, e.g. football stadiums, offshore installations (oil rigs), barracks, public toilets, etc.</i></p>													
<b>2</b> Resistenza di durata Durability	6 7	6= 100.000 cicli di prova / test runs 7= 200.000 cicli di prova / test runs													
<b>3</b> Massa della porta Door mass	-														
<b>4</b> Resistenza al fuoco Fire resistance	0 1	0= non ammissibile per porte tagliafuoco o antifumo <i>not allowed for fire doors or anti-smoking doors</i> 1= adatta per porte tagliafuoco ed antifumo <i>suitable for fire and anti-smoking doors</i>													
<b>5</b> Sicurezza personale Safety	0 1	0= per uso normale / for normal use 1= per uso con requisiti di sicurezza <i>for use with safety requirements</i>													
<b>6</b> Resistenza alla corrosione Corrosion resistance	0 1 2 3 4 5	<p>0= nessuna resistenza definita alla corrosione <i>no corrosion resistance</i></p> <p>1= ridotta resistenza alla corrosione <i>low corrosion resistance</i></p> <p>2= media resistenza alla corrosione <i>medium corrosion resistance</i></p> <p>3= alta resistenza alla corrosione <i>high corrosion resistance</i></p> <p>4= resistenza molto elevata alla corrosione <i>very high corrosion resistance</i></p> <p>5= resistenza estremamente elevata alla corrosione <i>extreme corrosion resistance</i></p>	<table border="1"> <thead> <tr> <th>Finiture / Finishes</th> <th>Grado / Grade</th> </tr> </thead> <tbody> <tr> <td>Brunito/Burnished</td> <td>1</td> </tr> <tr> <td>Orsatop/Matt brass, Anticato/Antique, Cromoton/Satin black chrome, Nikelnero/Nickel black, Bronzop/Matt bronze, Bronzo scuro/Dark bronze</td> <td>2</td> </tr> <tr> <td>Ottone naturale antico/Antique natural brass, Fumè, Ramematt/Matt copper</td> <td>3</td> </tr> <tr> <td>Acciaio inox 304 lucido/Polished 304 stainless steel, Acciaio inox 304 satinato/Satin 304 stainless steel, Orolucido/Polished brass, Orsatop/Satin brass, Oransat/Antique gold/satin brass, Patinè, Nickel, Nikmatt, Niksatan/Antique satin nickel, Bronzsat, Neropaco/Matt black, Tortora/Grey, Biancopaco/Matt white, Rame/Copper, Light black</td> <td>4</td> </tr> <tr> <td>Acciaio inox 316 lucido/Polished 316 stainless steel, Acciaio inox 316 satinato/Satin 316 stainless steel, Orolucido-PVD/Polished brass-PVD, Orsatop-PVD/Satin brass-PVD, Cromo /Polished chrome, Cromo PVD/Polished chrome-PVD, Cromosat/Satin chrome, Cromosat-PVD/Satin chrome-PVD</td> <td>5</td> </tr> </tbody> </table>	Finiture / Finishes	Grado / Grade	Brunito/Burnished	1	Orsatop/Matt brass, Anticato/Antique, Cromoton/Satin black chrome, Nikelnero/Nickel black, Bronzop/Matt bronze, Bronzo scuro/Dark bronze	2	Ottone naturale antico/Antique natural brass, Fumè, Ramematt/Matt copper	3	Acciaio inox 304 lucido/Polished 304 stainless steel, Acciaio inox 304 satinato/Satin 304 stainless steel, Orolucido/Polished brass, Orsatop/Satin brass, Oransat/Antique gold/satin brass, Patinè, Nickel, Nikmatt, Niksatan/Antique satin nickel, Bronzsat, Neropaco/Matt black, Tortora/Grey, Biancopaco/Matt white, Rame/Copper, Light black	4	Acciaio inox 316 lucido/Polished 316 stainless steel, Acciaio inox 316 satinato/Satin 316 stainless steel, Orolucido-PVD/Polished brass-PVD, Orsatop-PVD/Satin brass-PVD, Cromo /Polished chrome, Cromo PVD/Polished chrome-PVD, Cromosat/Satin chrome, Cromosat-PVD/Satin chrome-PVD	5
Finiture / Finishes	Grado / Grade														
Brunito/Burnished	1														
Orsatop/Matt brass, Anticato/Antique, Cromoton/Satin black chrome, Nikelnero/Nickel black, Bronzop/Matt bronze, Bronzo scuro/Dark bronze	2														
Ottone naturale antico/Antique natural brass, Fumè, Ramematt/Matt copper	3														
Acciaio inox 304 lucido/Polished 304 stainless steel, Acciaio inox 304 satinato/Satin 304 stainless steel, Orolucido/Polished brass, Orsatop/Satin brass, Oransat/Antique gold/satin brass, Patinè, Nickel, Nikmatt, Niksatan/Antique satin nickel, Bronzsat, Neropaco/Matt black, Tortora/Grey, Biancopaco/Matt white, Rame/Copper, Light black	4														
Acciaio inox 316 lucido/Polished 316 stainless steel, Acciaio inox 316 satinato/Satin 316 stainless steel, Orolucido-PVD/Polished brass-PVD, Orsatop-PVD/Satin brass-PVD, Cromo /Polished chrome, Cromo PVD/Polished chrome-PVD, Cromosat/Satin chrome, Cromosat-PVD/Satin chrome-PVD	5														
<b>7</b> Sicurezza contro lo scasso Security	0 1 2 3 4	<p>0= nessuna resistenza contro eventuale scasso <i>no resistance against possible forced entry</i></p> <p>1= ridotta resistenza allo scasso <i>low resistance against possible forced entry</i></p> <p>2= media resistenza allo scasso <i>medium resistance against possible forced entry</i></p> <p>3= alta resistenza allo scasso <i>high resistance against possible forced entry</i></p> <p>4= resistenza molto elevata allo scasso <i>very high resistance against possible forced entry</i></p>													
<b>8</b> Tipo di azionamento Type of operation	A B C	A= con molla / with spring B= con precarico a molla / with spring preload C= senza molla / without spring													

	N1	Acciaio inox lucido
	N2	Acciaio inox satinato
	A	Orolucido
	A-PVD	Orolucido - PVD
	AB	Orsatin
	AB-PVD	Orsatin - PVD
	AC	Orsatop
	AD	Orolux
	AE	Oransat
	AF	Orantop
	B	Ottone naturale
	BA	Ottone naturale antico
	BB	Patinè
	BC	Brunito
	BD	Anticato
	C	Cromo
	C-PVD	Cromo - PVD
	CA	Cromosat
	CA-PVD	Cromosat - PVD
	CB	Cromoton
	D	Nickel
	DA	Nikmatt
	DB	Niksatan
	DC	Nikelnero
	E	Bronzsat
	EA	Bronzop
	EB	Fumè
	EC	Arant
	ED	Bronzo scuro
	F	Neropaco
	FA	Tortora
	FB	Biancopaco
	H-PVD	Titanium - PVD
	I	Rame
	IA	Ramematt
	L	Light black

	N1	Polished stainless steel
	N2	Satin stainless steel
	A	Polished brass
	A-PVD	Polished brass - PVD
	AB	Satin brass
	AB-PVD	Satin brass - PVD
	AC	Matt brass
	AD	Brass plated
	AE	Antique gold/satin brass
	AF	Antique matt gold
	B	Natural brass
	BA	Antique natural brass
	BB	Patiné
	BC	Burnished
	BD	Antique
	C	Polished chrome
	C-PVD	Polished chrome - PVD
	CA	Satin chrome
	CA-PVD	Satin chrome - PVD
	CB	Satin black chrome
	D	Nickel
	DA	Nikmatt
	DB	Antique satin nickel
	DC	Nickel black
	E	Bronzsat
	EA	Matt bronze
	EB	Fumé
	EC	Antique silver
	ED	Dark bronze
	F	Matt black
	FA	Grey
	FB	Matt white
	H-PVD	Titanium - PVD
	I	Copper
	IA	Matt copper
	L	Light black

**Standard:** Ogni serie di maniglie è disponibile a listino in una selezione di finiture  
 Each set of handles is available on list in a selection of finishes

**Fuori Standard:** l'intera gamma finiture è disponibile come fuori standard su tutte le serie in ottone e zama, alle seguenti condizioni:  
**Non-standard:** the whole range of finishes is available as out of standard on all brass and zama series, under the following conditions:

- valutazione della direzione tecnica / review of technical management
- ordinativo minimo #24 sets / minimal stock #24 sets
- lead-time di consegna: 6 settimane data ordine (PVD: 8 settimane) / lead-time delivery: 6 weeks from order date (PVD: 8 weeks)
- sovrapprezzo indicativo per ogni maniglia: +25% sulla finitura standard a prezzo più alto / indicative overpricing for each handle: +25% on the standard finish vs the highest price

**Custom:** finiture speciali a richiesta del Cliente (non in gamma), disponibili alle seguenti condizioni:  
 special finishes on Customer's request (not in range), available under the following conditions:

- valutazione della direzione tecnica / review of technical management
- da #5 a #24 sets: costo fisso €500 + sovrapprezzo indicativo per ogni maniglia pari a +25% sulla finitura standard a prezzo più alto / from #5 to #24 sets: fixed cost €500 + indicative overpricing for each handle of +25% on standard finish vs the highest price
- > #24 sets: sovrapprezzo indicativo per ogni maniglia pari a +25% sulla finitura standard a prezzo più alto / >#24 sets: indicative overpricing for each handle of +25% on standard finish vs the highest price
- lead-time di consegna: 6 settimane data ordine (PVD: 8 settimane) / lead time of delivery: 6 weeks from order date (PVD 8 weeks)

# Trattamento protettivo ad alta resistenza

## High grade protective coating

**ZIRTANIO® = PVD**

### Attestato di qualità

Si attesta che il trattamento della superficie effettuato ai nostri prodotti, denominato **ZIRTANIO** è garantito **30 anni\***.

Tale trattamento ha superato i seguenti test:

- Resistenza alla nebbia salina (1500 ore) secondo le norme ISO 9227 ASTM B117 DIN 50021
- Resistenza ai solventi secondo test MFK
- Resistenza ai prodotti specifici anticalcare
- Resistenza all'acido muriatico illimitata
- Resistenza di solidità alla luce senza alterazione secondo le norme UNI 9397

Per la pulizia consigliamo l'utilizzo di un panno inumidito con alcool.

\* Si declina ogni responsabilità per un utilizzo negligente od improprio dei prodotti.

### Quality Certificate

We certify that the treatment applied as a coating to the surface of our products and known as **ZIRTANIO** is guaranteed for **30 years\***.

This treatment has passed the following tests:

- Resistance to salt spray (1500 hours) conforming to standard ISO 9227 ASTM B117 DIN 50021
- Resistance to solvents conforming to standard MFK
- Resistance to specific anti-calcareous products
- Unlimited resistance to muriatic acid
- Resistance to alteration caused by strong light conforming to standard UNI 9397

For cleaning we advise using a cloth dampened with alcohol.

\* We disclaim all responsibility if there is negligent or inappropriate use of products.



La maniglia ed i suoi coordinati, ormai divenuti veri complementi d'arredo, sono comunque oggetti di uso quotidiano e quindi, inevitabilmente, soggetti ad una naturale usura. Inoltre, particolari situazioni climatiche, agenti atmosferici come salsedine e umidità o l'utilizzo in situazioni gravose, possono accelerare questi processi, intaccando lo strato protettivo e generando effetti corrosivi con conseguenze antiestetiche.

Grazie al trattamento **Zirtanio**, che viene effettuato sulla superficie dei prodotti, **Assa Abloy** Italia garantisce la protezione per **30 anni**.

Trattandosi di una finitura a richiesta gli uffici commerciali restano a completa disposizione per ogni ulteriore informazione e chiarimento.

The door handle and its accessories, which have become part of the furnishing of the home, are subject to daily use, and consequently to natural wear and tear. In addition, certain climatic conditions, or atmospheric agents such as salt-air or high humidity, or use in detrimental conditions can accelerate the ageing process, damaging the protective coating and causing corrosion with un-aesthetic results.

Thanks to the **Zirtanio** treatment, applied to the surface of the products, **Assa Abloy** Italia guarantees protection for **30 years**. This finish is applied on request.

For any further information or explanation you may require, please feel free to contact our offices.

**ZIRTANIO® = PVD**



### H 378

Serie YP Duemiladicotto  
design Yabu Pushellberg

Pag. 227



### H 377

Serie SL Duemilasedici  
design Steve Leung

Pag. 159



### H 376

Serie GV Duemilaquattordici  
design Giancarlo Vegni

Pag. 217



### H 375

Serie MT Duemilaquattordici  
design Marco Triaca

Pag. 209



**H 374** Serie Compasso  
Duemilaquattordici  
design Franco Poli

Pag. 191



### H 372

Serie EG Duemilaundici  
design Eri Goshen

Pag. 131



### H 370

Serie MDF Duemiladieci  
design Doriana e Massimiliano Fuksas

Pag. 119



### H 369

Serie EG Duemilanove  
design Eri Goshen

Pag. 135



### H 368

Serie CA Duemilanove  
design Cerri & Associati

Pag. 51



### H 367

Serie GV Duemilanove  
design Giancarlo Vegni

Pag. 221



### H 364

Serie MB Duemilanove  
design Mario Bellini

Pag. 21



### H 363

Serie EC Duemilanove  
design David Chipperfield

Pag. 67



### H 362

Serie CC Duemilanove  
design Carlo Colombo

Pag. 97



### H 361

Serie AC4 Duemilasei  
design Antonio Citterio con Toan Nguyen

Pag. 77



### H 359 Serie SOM

New York Duemilasette  
design Skidmore, Owings & Merrill

Pag. 197



### H 358

Serie JP1 Duemila  
design John Pawson

Pag. 179



### H 356

Serie ZH Duemilacinque  
design Zaha Hadid con Woody Yao

Pag. 141



### H 354

Serie FOG Duemilaquattro  
design Frank O. Gehry

Pag. 125



### H 352

Serie ODBC Duemiladue  
design Odile Decq - Benoît Cornette

Pag. 103



### H 350

Serie CA Duemiladue  
design Cerri & Associati

Pag. 55

# Maniglie in ottone per porta

## Door brass handles

---



**H 348**  
Serie DC Duemiladue  
design David Chipperfield Architects  
**Pag. 71**



**H 343**  
Serie JP Duemila  
design John Pawson  
**Pag. 183**



**H 341**  
Serie HK2 Duemila  
design Hans Kollhoff  
**Pag. 147**



**H 338**  
Serie YK Duemila  
design Yoshimi Kono  
**Pag. 153**



**H 335**  
Serie RM Novantotto  
design Richard Meier  
**Pag. 165**



**H 334**  
Serie NF Novantotto  
design Foster and Partners  
**Pag. 111**



**H 332**  
Serie M Novantotto  
design Renzo Mongiardino  
**Pag. 173**



**H 330**  
Serie T Novantasette  
design Matteo Thun  
**Pag. 203**



**H 329**  
Serie RB Novantacinque  
design Taller Design Ricardo Bofill  
**Pag. 37**



**H 327**  
Serie AC 2 Novantacinque  
design Antonio Citterio  
**Pag. 83**



**H 326**  
Serie AC 1 Novantacinque  
design Antonio Citterio  
**Pag. 87**



**H 317**  
Serie AC Novantuno  
design Antonio Citterio  
**Pag. 91**



**H 315**  
Serie G Novanta  
design Pierluigi Cerri  
**Pag. 61**



**H 311**  
Serie Sei MB  
design Mario Bellini  
**Pag. 25**



**H 310**  
Serie Cinque C  
design Achille Castiglioni  
**Pag. 45**



**H 37**  
Serie Tre B  
design Cini Boeri  
**Pag. 31**





**H 5022 \***  
Serie **Einser**  
design Jan Kleihues

**Pag. 256**



**H 5021**  
Serie **Arrowhead**  
design Frank O. Gehry

**Pag. 258**



**H 5017**  
Serie **Gottardo**  
design Hans Kollhoff

**Pag. 260**



**H 5015**  
Serie **K2**  
design Antonio Citterio

**Pag. 262**



**H 5014**  
Serie **Bernina**  
design Fusital Workshop

**Pag. 265**



**H 5010 \***  
Serie **Cresta**  
design Foster and Partners

**Pag. 267**



**H 5008**  
Serie **Himalaya**  
design Taller Design Ricardo Bofill

**Pag. 270**



**H 5005 \***  
Serie **Amiata**  
design D'Urbino Lomazzi

**Pag. 274**



**H 5001 \***  
Serie **Cervino**  
design Fusital Workshop

**Pag. 276**



\* **Quantità minima 24 sets, tempi di produzione 8 settimane**  
*Minimum order quantity: 24 sets, 8 weeks lead time*

# Indice Designers

## Designers Index

---

<b>Mario Bellini</b>	Pag	19
<b>Cini Boeri</b>	Pag	29
<b>Taller Design Ricardo Bofill</b>	Pag	35
<b>Achille Castiglioni</b>	Pag	43
<b>Pierluigi Cerri</b>	Pag	49
<b>David Chipperfield</b>	Pag	65
<b>Antonio Citterio</b>	Pag	75
<b>Carlo Colombo</b>	Pag	95
<b>Odile Decq - Benoît Cornette</b>	Pag	101
<b>Foster and Partners</b>	Pag	109
<b>Doriana e Massimiliano Fuksas</b>	Pag	117
<b>Frank O. Gehry</b>	Pag	123
<b>Eri Goshen</b>	Pag	129
<b>Zaha Hadid</b>	Pag	139
<b>Hans Kollhoff</b>	Pag	145
<b>Yoshimi Kono</b>	Pag	151
<b>Steve Leung</b>	Pag	157
<b>Richard Meier</b>	Pag	163
<b>Renzo Mongiardino</b>	Pag	171
<b>John Pawson</b>	Pag	177
<b>Franco Poli</b>	Pag	189
<b>Skidmore, Owings &amp; Merrill</b>	Pag	195
<b>Matteo Thun</b>	Pag	201
<b>Marco Triaca</b>	Pag	207
<b>Giancarlo Vegni</b>	Pag	215
<b>Yabu Pushelberg</b>	Pag	225

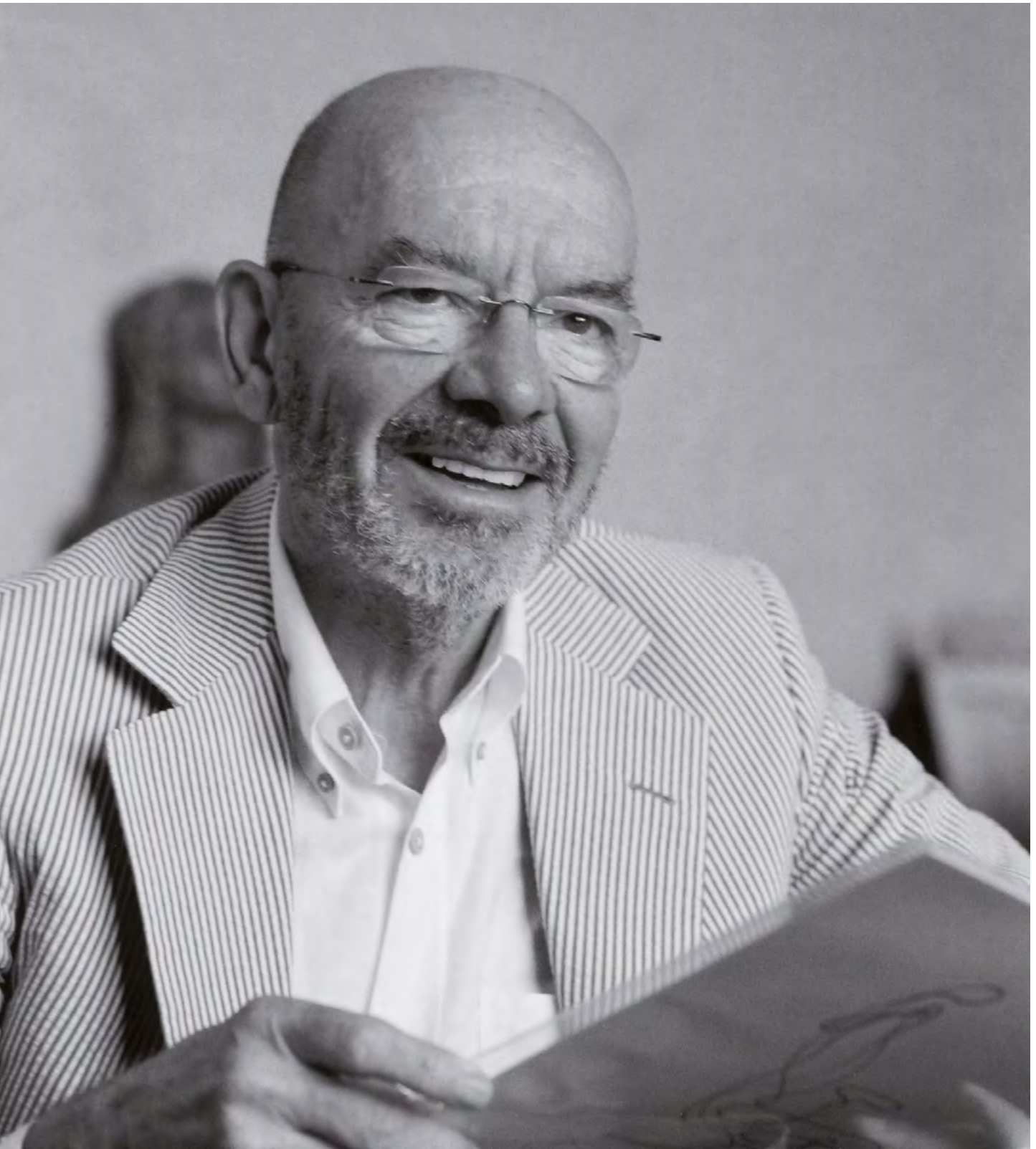

**Architetto e designer di fama internazionale, premiato 8 volte con il Compasso d'Oro ed insignito di prestigiosi riconoscimenti, ha 25 opere nella collezione permanente del MoMA di New York che nel 1987 gli ha dedicato una retrospettiva. In architettura ha realizzato, tra l'altro, il quartiere Portello di Fiera Milano, il Centro Esposizioni di Villa Erba, il Tokyo Design Center in Giappone, Natuzzi Headquarters negli Stati Uniti, la National Gallery of Victoria a Melbourne, la sede centrale della Deutsche Bank a Francoforte, il Verona Forum, il Museo della Storia di Bologna, il Museo di Arti Islamiche al Louvre e il Convention Center a Milano.**

---

Internationally renowned architect and designer, winner of 8 Compasso d'Oro and prestigious architecture awards, he has 25 works in the Permanent Design Collection of MoMA, which dedicated to him a personal exhibition in 1987. He has designed projects such as the Portello Trade Fair quarter in Milan, the Villa Erba Exhibition Centre, the Tokyo Design Center in Japan, Natuzzi America Headquarters, the Essen Trade Fair in Germany, the National Gallery of Victoria in Melbourne, the Deutsche Bank headquarters in Frankfurt, the Verona Forum, the Museum of the History of Bologna, the Museum of Islamic Art in the Louvre and the Milan Convention Center.





# H 364

Serie MB Duemilanove  
design Mario Bellini

**Maniglia per porta**  
Door handle

**Materiale Ottone**  
Material Brass

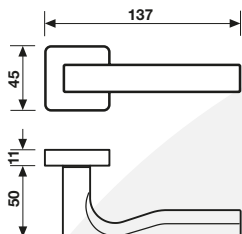

## Finiture

Finishes



Cromo



Cromosat



Disponibile anche CLASSE 4 su R8 / RG8  
secondo la norma DIN EN 1906 - Digit 4 7 - 01 - 0 B  
Available also CLASS 4 on R8 / RG8  
according to the DIN Standard EN 1906 - Digit 4 7 - 01 - 0 B

## H 364 FRS-41

**Maniglia per finestra**  
Window handle

**Movimento**  
4 scatti  
Movement  
4 click positions

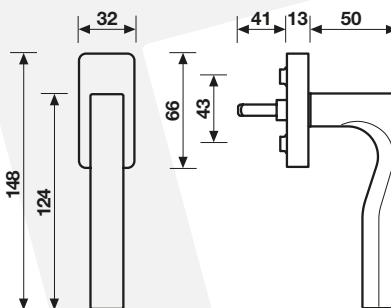

### H 364 R7 / R8

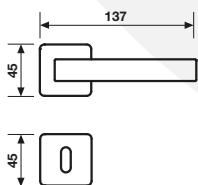

### H 364 R7 Y / R8 Y

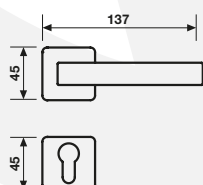

### H 364 RG8 / 8.5

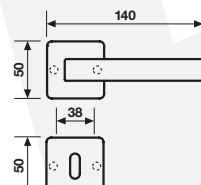

### H 364 RG8 / 8.5 Y

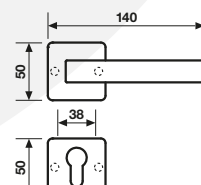

### H 364 RG6-7-8 BZG

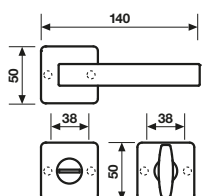

### H 364 RQ Privacy

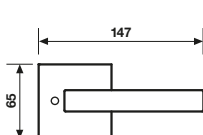

### H 364 RQ Passage

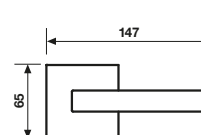

### H 364 RSB

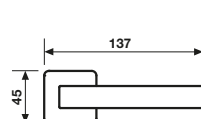

## K 3032

**Bocchetta**  
Escutcheon



**Materiale Nikrall Lega Zama UNI 3717**  
Material Nikrall Lega Zama UNI 3717

**Finiture / Finishes**  
Cromo  
Cromosat

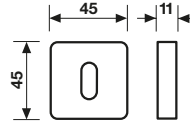

**K 3032**  
Foro chiave normale  
Standard hole  
escutcheon

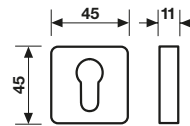

**K 3032 Y**  
Foro chiave cilindro  
Euro-profile hole  
escutcheon

## K 3034 CP

**Bocchetta per RG8**  
Escutcheon for RG8



**Materiale Nikrall Lega Zama UNI 3717**  
Material Nikrall Lega Zama UNI 3717

**Finiture / Finishes**  
Cromo  
Cromosat

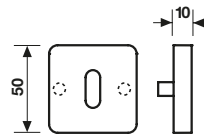

**K 3034 CP**  
Foro chiave normale  
Standard hole  
escutcheon

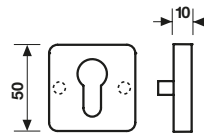

**K 3034 CP Y**  
Foro chiave cilindro  
Euro-profile hole  
escutcheon

## K 3038

**Bocchetta stretta**  
Narrow Escutcheon

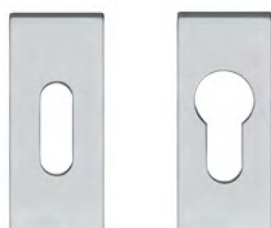

**Materiale Ottone**  
Material Brass

**Finiture / Finishes**  
Cromo  
Cromosat

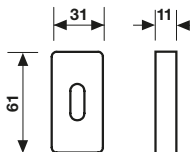

**K 3038**  
Foro chiave normale  
Standard hole  
escutcheon

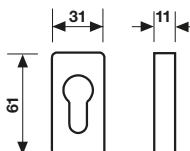

**K 3038 Y**  
Foro chiave cilindro  
Euro-profile hole  
escutcheon

## K 3029

**Materiale Ottone**  
Material Brass

**Finiture / Finishes**  
Cromo  
Cromosat

**Chiusura privacy BZG**  
Bathroom privacy set

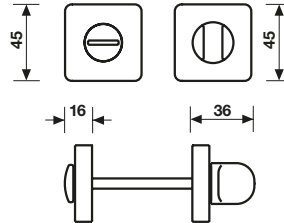

**K 3029 R6-7-8 BZG - 85**



**K 3029 RS6-7-8 BZG - 85**



## K 3029 RG8

**Materiale Nikrall Lega Zama UNI 3717**  
Material Nikrall Lega Zama UNI 3717

**Finiture / Finishes**  
Cromo  
Cromosat

**Chiusura privacy BZG per RG8**  
Bathroom privacy set for RG8

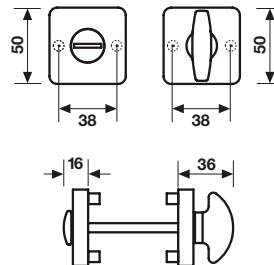

**K 3029 RG6-7-8 BZG - 75**





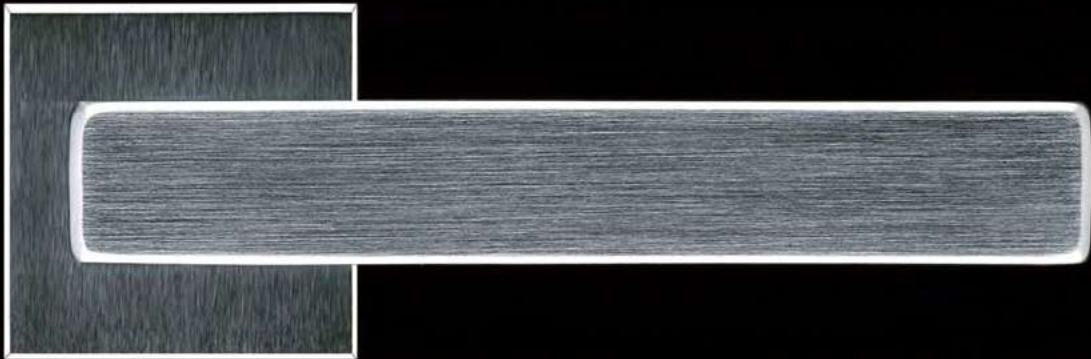
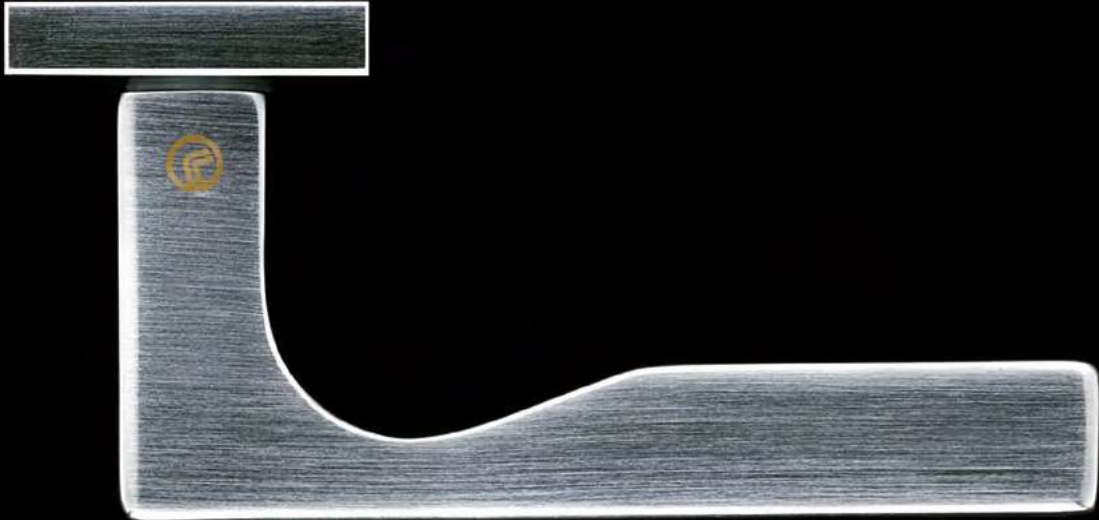

# H 311

Serie **Sei MB**  
design Mario Bellini

**Maniglia per porta**  
Door handle

**Materiale Ottone**  
Material Brass

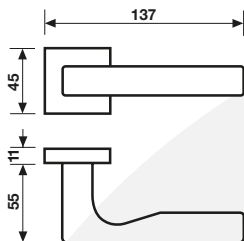

## Finiture

Finishes



Cromo



Cromosat



Disponibile anche CLASSE 4 su R8 / RG8  
secondo la norma DIN EN 1906 - Digit 4 7 - 01 - 0 B  
Available also CLASS 4 on R8 / RG8  
according to the DIN Standard EN 1906 - Digit 4 7 - 01 - 0 B

## H 311 FRS-41

**Maniglia per finestra**  
Window handle

**Movimento**  
4 scatti  
Movement  
4 click positions

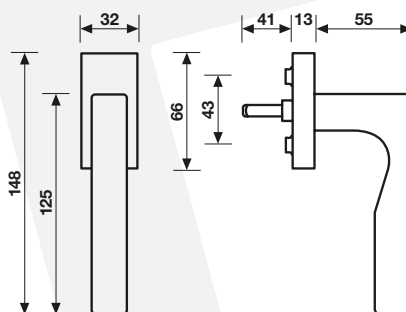

### H 311 R7 / R8

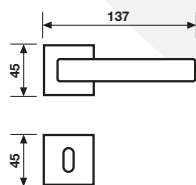

### H 311 R7 Y / R8 Y

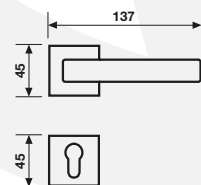

### H 311 RG8 / 8.5

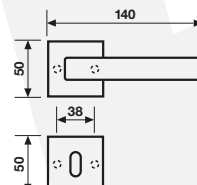

### H 311 RG8 / 8.5 Y

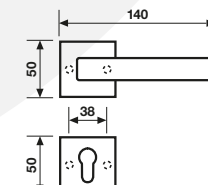

### H 311 RG6-7-8 BZG

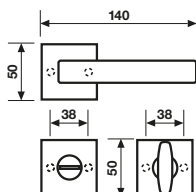

### H 311 RQ Privacy

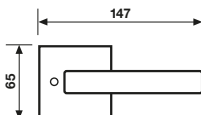

### H 311 RQ Passage

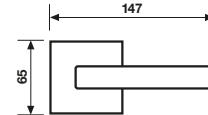

### H 311 RSB

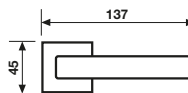

## K 3031

**Bocchetta**  
Escutcheon



**Materiale Nikrall Lega Zama UNI 3717**  
Material Nikrall Lega Zama UNI 3717

**Finiture / Finishes**  
Cromo  
Cromosat

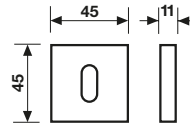

**K 3031**  
Foro chiave normale  
Standard hole  
escutcheon

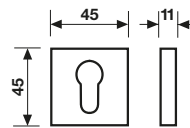

**K 3031 Y**  
Foro chiave cilindro  
Euro-profile hole  
escutcheon

## K 3033 CP

**Bocchetta per RG8**  
Escutcheon for RG8



**Materiale Nikrall Lega Zama UNI 3717**  
Material Nikrall Lega Zama UNI 3717

**Finiture / Finishes**  
Cromo  
Cromosat

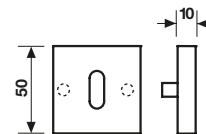

**K 3033 CP**  
Foro chiave normale  
Standard hole  
escutcheon

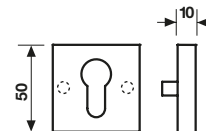

**K 3033 CP Y**  
Foro chiave cilindro  
Euro-profile hole  
escutcheon

## K 3038

**Bocchetta stretta**  
Narrow Escutcheon

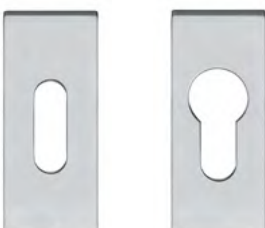

**Materiale Ottone**  
Material Brass

**Finiture / Finishes**  
Cromo  
Cromosat

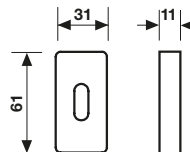

**K 3038**  
Foro chiave normale  
Standard hole  
escutcheon

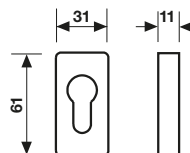

**K 3038 Y**  
Foro chiave cilindro  
Euro-profile hole  
escutcheon

## K 3013

**Materiale Nikrall Lega Zama UNI 3717**  
Material Nikrall Lega Zama UNI 3717

**Finiture / Finishes**  
Cromo  
Cromosat

**Chiusura privacy BZG**  
Bathroom privacy set

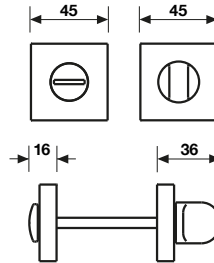

**K 3013 R6-7-8 BZG - 85**



## K 3020

**Materiale Nikrall Lega Zama UNI 3717**  
Material Nikrall Lega Zama UNI 3717

**Finiture / Finishes**  
Cromo  
Cromosat

**Chiusura privacy BZG per RG8**  
Bathroom privacy set for RG8

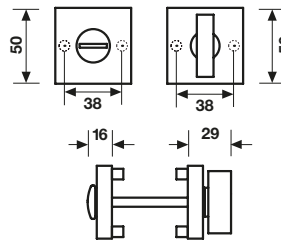

**K 3020 RG6-7-8 BZG - 85**





**Laureata al Politecnico di Milano nel 1951, dopo una lunga collaborazione con Marco Zanuso, inizia la propria attività professionale nel 1963, occupandosi di architettura civile, e disegno industriale. Ha progettato in Italia e all'estero case unifamiliari, appartamenti, allestimenti museali, uffici, negozi, dedicando grande attenzione allo studio della funzionalità dello spazio e ai rapporti psicologici tra l'uomo e l'ambiente. Nell'ambito del disegno industriale si è occupata in modo particolare del progetto di elementi per l'arredo e componenti per l'edilizia. Diverse sue realizzazioni sono presenti in musei ed esposizioni internazionali. Ha tenuto conferenze e lezioni presso diverse università e istituzioni in Italia ed all'estero e partecipato a numerose giurie di concorsi internazionali.**

---

Graduated at Milan Polytechnic in 1951. After a long period of collaboration with Marco Zanuso, she founded her own practice in 1963, focusing her activity on civil architecture and industrial design. Her architectural projects in Italy and abroad include apartments, houses, shops, showrooms, office buildings, museums. She has devoted particular attention to the function of the house and the psychological relationship between people and their living environment. Her work in industrial design has been particularly aimed at developing furniture pieces as well as building components. Many of her projects are exhibited in museums and international exhibitions worldwide. She has lectured at various universities and institutions both in Italy and abroad. She was member of the Jury in many international contests.





# H 37

Serie **Tre B**  
design Cini Boeri

**Maniglia per porta**  
Door handle

**Materiale Ottone**  
Material Brass

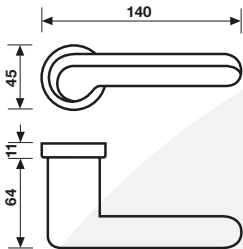

## Finiture

Finishes



Orsatina

## H 37 FRS-41

**Maniglia per finestra**  
Window handle

**Movimento**  
4 scatti  
Movement  
4 click positions

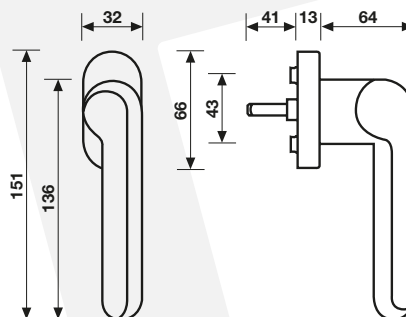

### H 37 R7 / R8

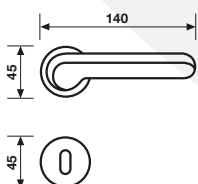

### H 37 R7 Y / R8 Y

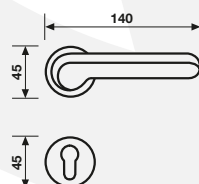

### H 37 RG8 / 8.5

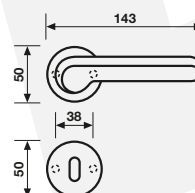

### H 37 RG8 / 8.5 Y

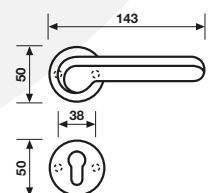

### H 37 RG6-7-8 BZG

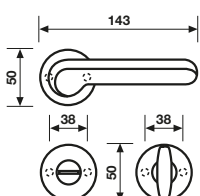

### H 37 RSB

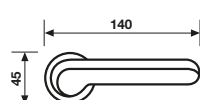



## K 387

**Materiale Ottone**  
Material Brass

**Finiture / Finishes**  
Orsatin

**Bocchetta**  
Escutcheon

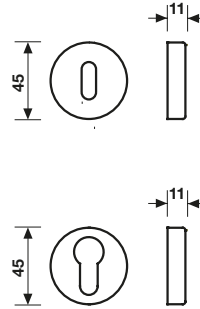
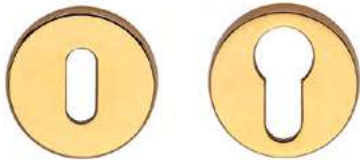

**K 387**  
Foro chiave normale  
Standard hole  
escutcheon

**K 387 Y**  
Foro chiave cilindro  
Euro-profile hole  
escutcheon

## K 3703 CP

**Materiale Ottone**  
Material Brass

**Finiture / Finishes**  
Orsatin

**Bocchetta per RG8**  
Escutcheon for RG8

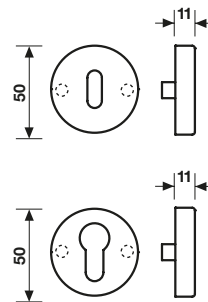

**K 3703 CP**  
Foro chiave normale  
Standard hole  
escutcheon

**K 3703 Y CP**  
Foro chiave cilindro  
Euro-profile hole  
escutcheon

## K 3037

**Materiale Ottone**  
Material Brass

**Finiture / Finishes**  
Orsatin

**Bocchetta stretta**  
Narrow Escutcheon

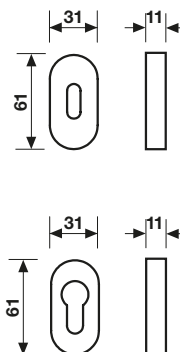

**K 3037**  
Foro chiave normale  
Standard hole  
escutcheon

**K 3037 Y**  
Foro chiave cilindro  
Euro-profile hole  
escutcheon

## K 382

**Materiale Ottone**  
Material Brass

**Finiture / Finishes**  
Orsatin

**Chiusura privacy BZG**  
Bathroom privacy set

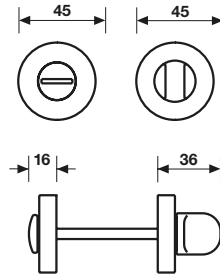

**K 382 R6-7-8 BZG - 85**



**K 382 RS6-7-8 BZG - 85**



## K 389 RG8

**Materiale Ottone**  
Material Brass

**Finiture / Finishes**  
Orsatin

**Chiusura privacy BZG per RG8**  
Bathroom privacy set for RG8

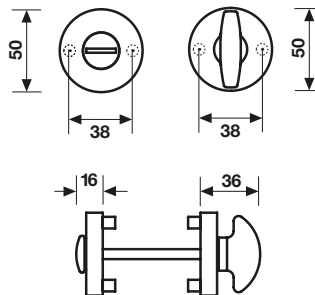

**K 389 RG6-7-8 50 BZG 75**





**Sia la progettazione di interni di abitazioni, uffici, aeroporti, teatri o impianti sportivi, Ricardo Bofill Taller de Arquitectura si impegna alla messa a punto dei suoi progetti fino all'ultimo dettaglio. Taller Design prende in considerazione il rapporto tra lo spazio interno e il progetto globale che si differenzia in ogni caso. Luce particolare e temperatura sono in grado di creare uno spazio favorevole all'attività o alla riflessione, al lavoro di gruppo o individuale. Gli spazi interni progettati da Design Taller sono armoniosi e neutri, e la diversità di materiali e decorazioni è limitata, per ottenere il massimo comfort per i suoi abitanti o utenti. Le linee sono semplici e pulite, esteticamente gradevoli, funzionali ed ergonomiche.**

---

Whether designing the interiors of residential, office buildings, airports, theatres or sports facilities, Ricardo Bofill's Taller de Arquitectura is committed to fine-tuning its projects down to the last detail. Taller Design takes into account the relationship between interior space and the overall project which differs in each case. A particular light and temperature can generate a space conducive to activity or reflection, group or individual work. Interior spaces designed by the Taller Design are harmonious and neutral, and the diversity of materials and decoration is limited, to achieve optimum comfort for its inhabitants or users. The lines are simple and clean, aesthetically pleasing, functional and ergonomic.

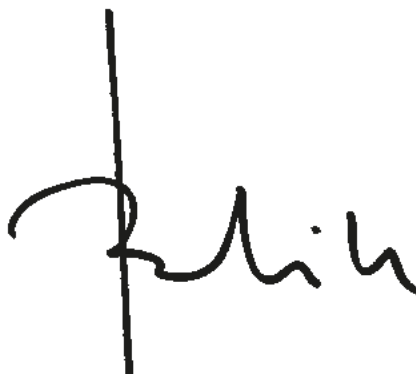



# H 329

Serie **RB Novantacinque**  
design Taller Design Ricardo Bofill

**Maniglia per porta**  
Door handle

**Materiale Ottone**  
Material Brass

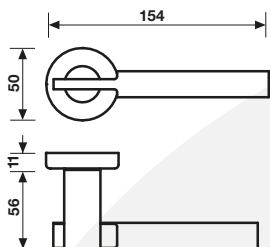

## Finiture

Finishes



Cromo/Cromosat



Oro/Orsatin



### H 329 R7 / R8

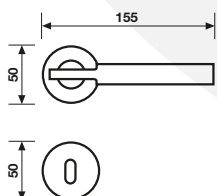

### H 329 R7 Y / R8 Y

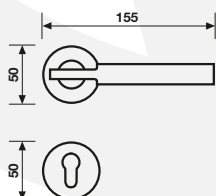

### H 329 RG8 / 8.5

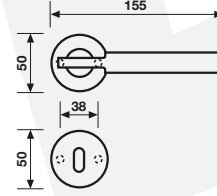

### H 329 RG8 / 8.5 Y

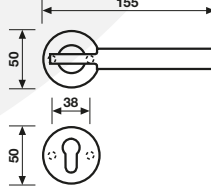

### H 329 RG6-7-8 BZG

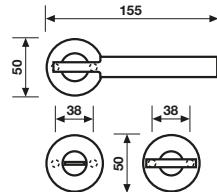

### H 329 RP Passage

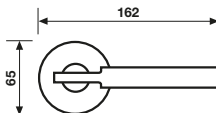

### H 329 RP Privacy

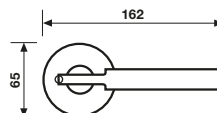

### H 329 RSB

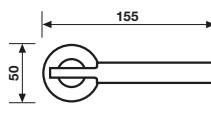

**Materiale Ottone**  
Material Brass

**Finiture Finishes**  
Cromo / Cromosat  
Oro / Orsatin

## H 329 FRS-41

**Maniglia per finestra**  
Window handle

**Movimento**  
**4 scatti**  
Movement  
4 click positions

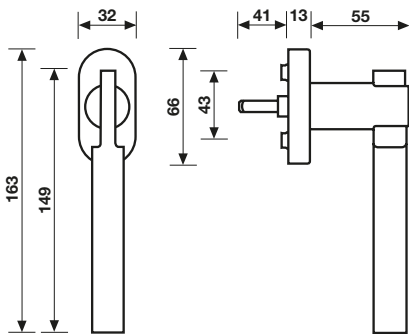

# K 353

Serie **RB Novantacinque**  
design Taller Design Ricardo Bofill

## **Materiale Ottone**

Material Brass

## **Finiture Finishes**

Cromo / Cromosat

Oro / Orsatin

## **K 353 / K 353 S**

### **Maniglione**

Pull Handle

### **Interasse / Centre distance**

250 mm

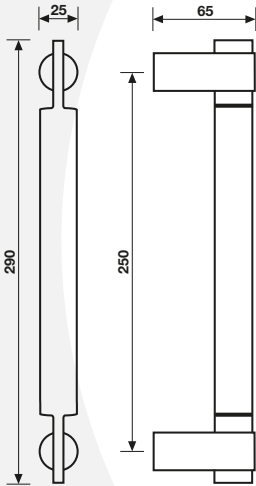



## K 383

**Materiale Ottone**  
Material Brass

**Finiture / Finishes**  
Cromo  
Orolucido

**Bocchetta**  
Escutcheon

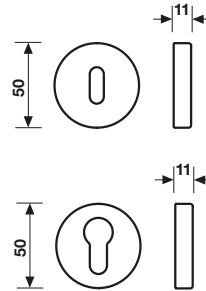

**K 383**  
Foro chiave normale  
Standard hole  
escutcheon

**K 383 Y**  
Foro chiave cilindro  
Euro-profile hole  
escutcheon

## K 3703 CP

**Materiale Ottone**  
Material Brass

**Finiture / Finishes**  
Cromo  
Orolucido

**Bocchetta per RG8**  
Escutcheon for RG8

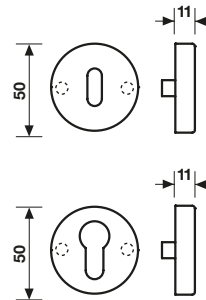

**K 3703 CP**  
Foro chiave normale  
Standard hole  
escutcheon

**K 3703 Y CP**  
Foro chiave cilindro  
Euro-profile hole  
escutcheon

## K 3037

**Materiale Ottone**  
Material Brass

**Finiture / Finishes**  
Cromo  
Orolucido

**Bocchetta stretta**  
Narrow Escutcheon

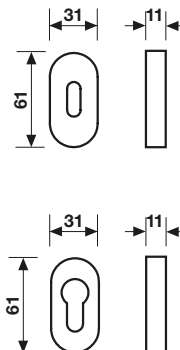

**K 3037**  
Foro chiave normale  
Standard hole  
escutcheon

**K 3037 Y**  
Foro chiave cilindro  
Euro-profile hole  
escutcheon

## K 382 50

**Materiale Ottone**  
Material Brass

**Finiture / Finishes**  
Cromo  
Orolucido

**Chiusura privacy BZG**  
Bathroom privacy set

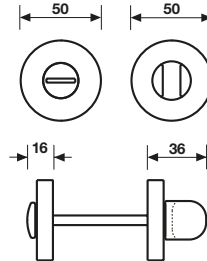

**K 382 R6-7-8 50 BZG - 85**



**K 382 RS6-7-8 50 BZG - 85**



## K 389 RG8

**Materiale Ottone**  
Material Brass

**Finiture / Finishes**  
Cromo  
Orolucido

**Chiusura privacy BZG per RG8**  
Bathroom privacy set for RG8

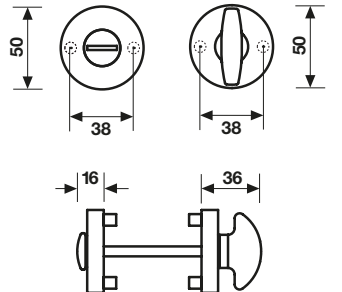

**K 389 RG6-7-8 50 BZG 75**





**Si è laureato in Architettura nel 1944. Professore ordinario di Disegno industriale a Torino e poi a Milano. Laurea Honoris causa al Royal College of Art di Londra. Moltissimi sono i progetti da lui firmati per le aziende: Alessi, Brionvega, Flos, Olivetti, Lancia, Zanotta, Cassina, Bernini, Danese, Marcatre, Up&Up, Ideal Standard, Vlm, Interflex, Fusital, De Padova, Kartell. Allestimenti per esposizioni: Triennale di Milano, Montecatini, Agip, Rai, ecc. Molte sue opere sono nella collezione al Moma di New York, e in musei di Londra, Zurigo, Monaco, Praga, Gerusalemme. Premio “The Chartered Society of Designers” Londra e “Premio Barcellona Design”. Gli sono stati conferiti nove Compassi d’Oro.**

---

Graduated in architecture in 1944. He was professor of Industrial Design in Turin and then in Milan. The Royal College of Art in London awarded him an honorary degree. Projects have been completed for the following companies: Alessi, Brionvega, Flos, Olivetti, Lancia, Zanotta, Cassina, Bernini, Danese, Marcatre, Up&Up, Ideal Standard, Vlm, Interflex, Fusital, De Padova, Kartell. Exhibitions he has fitted out include: Triennale of Milan, Montecatini, Agip, Rai, etc. Many of his works are in the collections at the Museum of Modern Art in New York, and Museums in London, Zurich, Munich, Prague and Jerusalem. Awards include the prize of “The Chartered Society of Designers” in London and the “Barcellona Design Prize”. He has also received nine Compassi d’Oro.



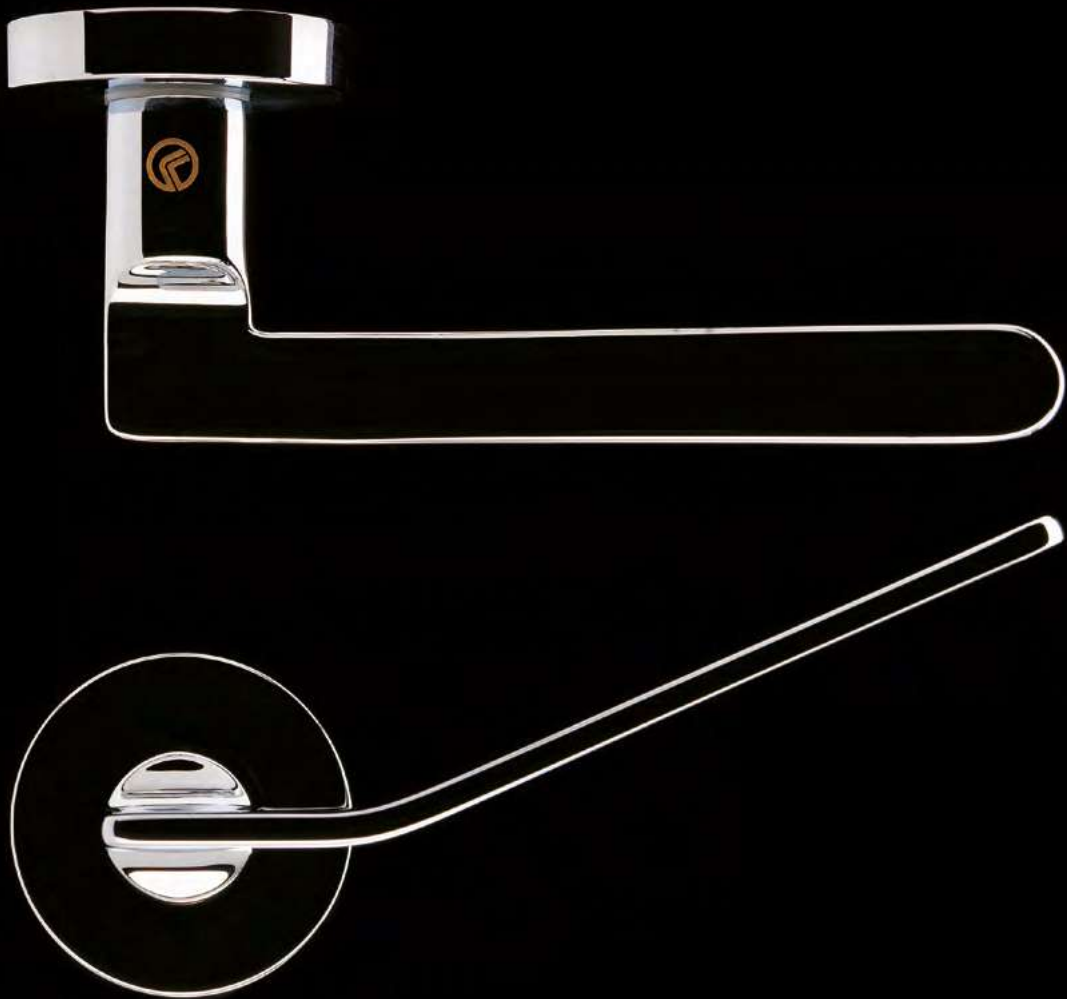

# H 310

Serie **Cinque C**  
design Achille Castiglioni

**Maniglia per porta**  
Door handle

**Materiale Ottone**  
Material Brass

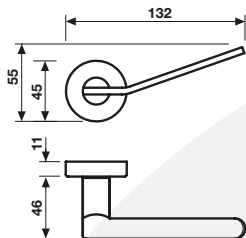

## Finiture

Finishes



Cromo



Cromosat



## H 310 FRS-41

**Maniglia per finestra**  
Window handle

**Movimento**  
4 scatti  
Movement  
4 click positions

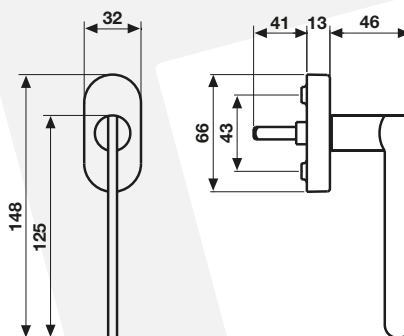

### H 310 R7 / R8

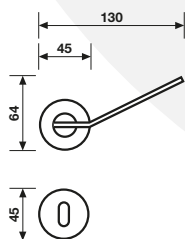

### H 310 R7 Y / R8 Y

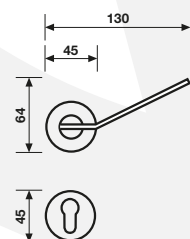

### H 310 RG8 / 8.5

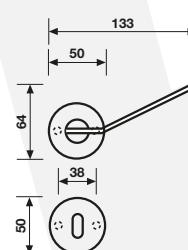

### H 310 RG8 / 8.5 Y

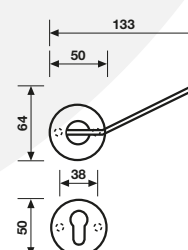

### H 310 RG6-7-8 BZG

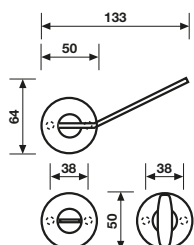

### H 310 RP Passage

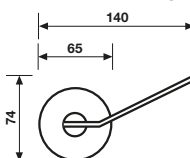

### H 310 RP Privacy

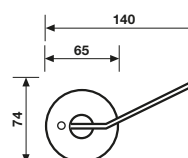

### H 310 RSB

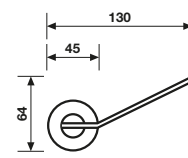

## K 387

**Materiale Ottone**  
Material Brass

**Finiture / Finishes**  
Cromo  
Cromosat

**Bocchetta**  
Escutcheon

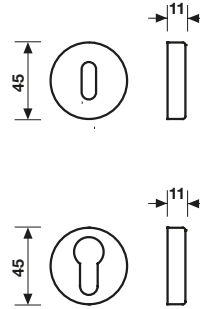

**K 387**  
Foro chiave normale  
Standard hole  
escutcheon

**K 387 Y**  
Foro chiave cilindro  
Euro-profile hole  
escutcheon

## K 3703 CP

**Materiale Ottone**  
Material Brass

**Finiture / Finishes**  
Cromo  
Cromosat

**Bocchetta per RG8**  
Escutcheon for RG8

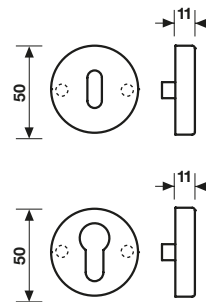

**K 3703 CP**  
Foro chiave normale  
Standard hole  
escutcheon

**K 3703 Y CP**  
Foro chiave cilindro  
Euro-profile hole  
escutcheon

## K 3037

**Materiale Ottone**  
Material Brass

**Finiture / Finishes**  
Cromo  
Cromosat

**Bocchetta stretta**  
Narrow Escutcheon

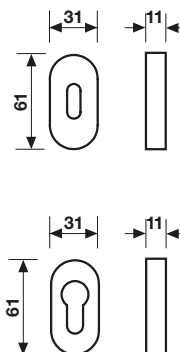

**K 3037**  
Foro chiave normale  
Standard hole  
escutcheon

**K 3037 Y**  
Foro chiave cilindro  
Euro-profile hole  
escutcheon

## K 382

**Materiale Ottone**  
Material Brass

**Finiture / Finishes**  
Cromo  
Cromosat

**Chiusura privacy BZG**  
Bathroom privacy set

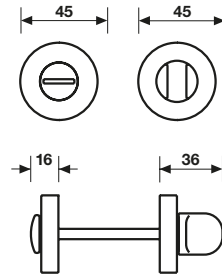

**K 382 R6-7-8 BZG - 85**



**K 382 RS6-7-8 BZG - 85**



## K 389 RG8

**Materiale Ottone**  
Material Brass

**Finiture / Finishes**  
Cromo  
Cromosat

**Chiusura privacy BZG per RG8**  
Bathroom privacy set for RG8

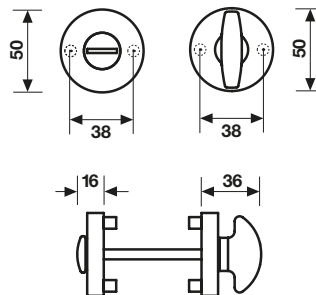

**K 389 RG6-7-8 50 BZG - 75**







**Pierluigi Cerri si è laureato al Politecnico di Milano. Nel 1974 è socio fondatore della Gregotti Associati con cui ha vinto numerosi concorsi d'architettura. Membro dell'Alliance Graphique Internationale, nel 1976 ha diretto l'immagine della Biennale di Venezia; è stato responsabile dell'immagine della Kunst-und Ausstellungshalle di Bonn e di Palazzo Grassi a Venezia. Ha vinto numerosi premi fra cui il Compasso d'Oro nel 1995, 2001 e 2004; nel 1994 il premio Art Director Club alla Carriera, l'Award for Good Industrial Design e l'International Super Yacht Design Award; nel 2006 il Premio Nazionale Ance-In/Arch. Nel 1998 fonda con Alessandro Colombo lo Studio Cerri & Associati.**

---

Pierluigi Cerri graduated from Polytechnic University of Milan. In 1974 he was a co-founder of Gregotti Associati for which he won several architectural contests. As a member of International Alliance Graphique, he directed the image of the Venice Biennale in 1976; he has been also responsible for the images of Kunst-und Ausstellungshalle in Bonn and Palazzo Grassi in Venice. He was awarded several prizes including Compasso d'Oro in 1995, 2001 and 2004; Carrier award of Art Director Club in 1994, Award for Good Industrial Design and International Superyacht Design Award, the National Ance-In/Arch in 2006. In 1998 he founded Studio Cerri & Associati together with Alessandro Colombo.

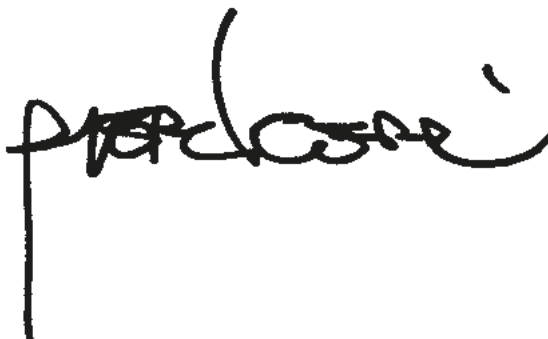



# H 368

Serie CA Duemilanove  
design Cerri & Associati

**Maniglia per porta**  
Door handle

**Materiale Ottone**  
Material Brass

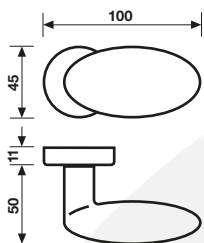

## Finiture

Finishes



Cromo



Cromosat



Disponibile anche CLASSE 4 su R8 / RG8  
secondo la norma DIN EN 1906 - Digit 4 7 - 01 - 0 B  
Available also CLASS 4 on R8 / RG8  
according to the DIN Standard EN 1906 - Digit 4 7 - 01 - 0 B

## H 368 FRS-41

**Maniglia per finestra**  
Window handle

**Movimento**  
4 scatti  
Movement  
4 click positions

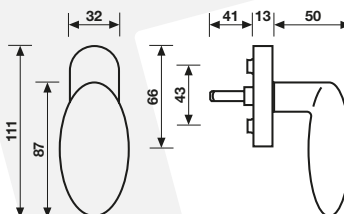

### H 368 R7 / R8

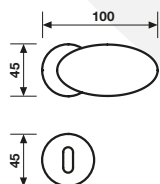

### H 368 R7 Y / R8 Y

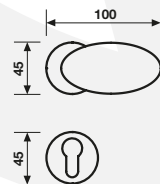

### H 368 RG8 / 8.5

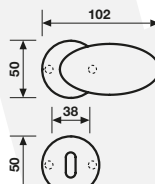

### H 368 RG8 / 8.5 Y

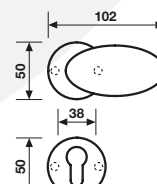

### H 368 RG6-7-8 BZG

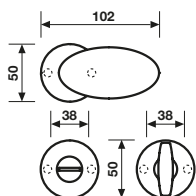

### H 368 RP Passage

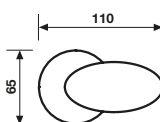

### H 368 RP Privacy

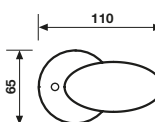

### H 368 RSB

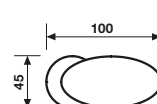

## K 387

**Materiale Ottone**  
Material Brass

**Finiture / Finishes**  
Cromo  
Cromosat

**Bocchetta**  
Escutcheon

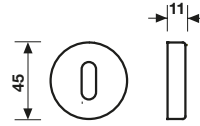

**K 387**  
Foro chiave normale  
Standard hole  
escutcheon

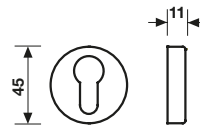

**K 387 Y**  
Foro chiave cilindro  
Euro-profile hole  
escutcheon

## K 3703 CP

**Materiale Ottone**  
Material Brass

**Finiture / Finishes**  
Cromo  
Cromosat

**Bocchetta per RG8**  
Escutcheon for RG8

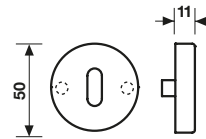

**K 3703 CP**  
Foro chiave normale  
Standard hole  
escutcheon

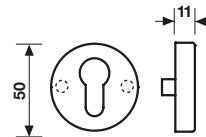

**K 3703 Y CP**  
Foro chiave cilindro  
Euro-profile hole  
escutcheon

## K 3037

**Materiale Ottone**  
Material Brass

**Finiture / Finishes**  
Cromo  
Cromosat

**Bocchetta stretta**  
Narrow Escutcheon

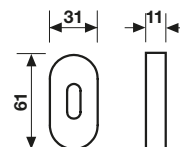

**K 3037**  
Foro chiave normale  
Standard hole  
escutcheon

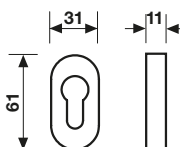

**K 3037 Y**  
Foro chiave cilindro  
Euro-profile hole  
escutcheon

## K 382

**Materiale Ottone**  
Material Brass

**Finiture / Finishes**  
Cromo  
Cromosat

**Chiusura privacy BZG**  
Bathroom privacy set

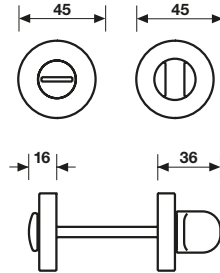

**K 382 R6-7-8 BZG - 85**



**K 382 RS6-7-8 BZG - 85**



## K 389 RG8

**Materiale Ottone**  
Material Brass

**Finiture / Finishes**  
Cromo  
Cromosat

**Chiusura privacy BZG per RG8**  
Bathroom privacy set for RG8

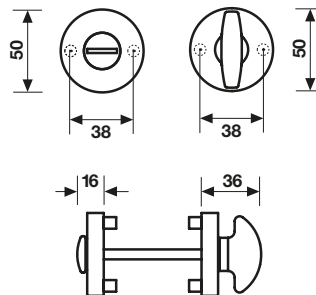

**K 389 RG6-7-8 50 BZG - 75**



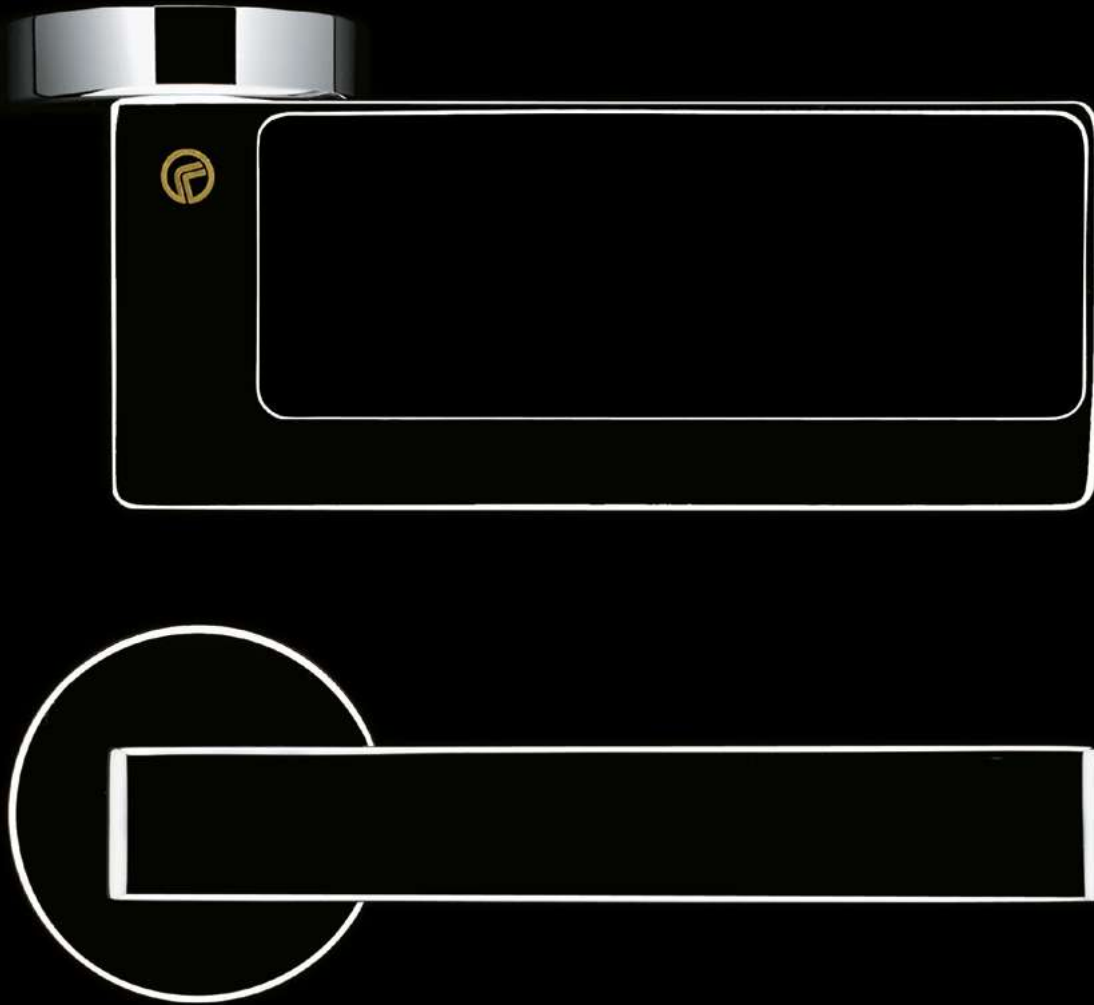

# H 350

Serie CA Duemiladue  
design Cerri & Associati

**Maniglia per porta**  
Door handle

**Materiale Ottone**  
Material Brass

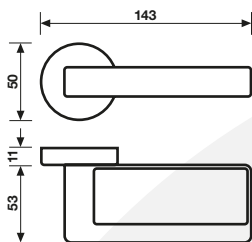

## Finiture

Finishes



Cromo



Cromosat



Disponibile anche CLASSE 4 su R8 / RG8  
secondo la norma DIN EN 1906 - Digit 4 7 - 01 - 0 B  
Available also CLASS 4 on R8 / RG8  
according to the DIN Standard EN 1906 - Digit 4 7 - 01 - 0 B

### H 350 R7 / R8

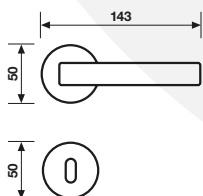

### H 350 R7 Y / R8 Y

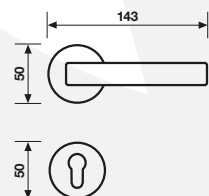

### H 350 RG8 / 8.5

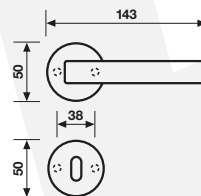

### H 350 RG8 / 8.5 Y

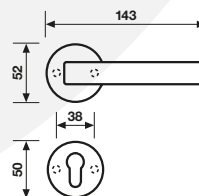

### H 350 RG6-7-8 BZG

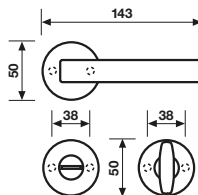

### H 350 RP Passage

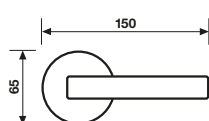

### H 350 RP Privacy

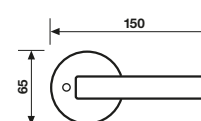

### H 350 RSB

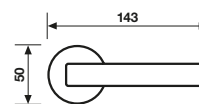



**Materiale Ottone**  
Material Brass

**Finiture Finishes**  
Cromo  
Cromosat

## H 350 FRS-41

**Maniglia per finestra**  
Window handle

**Movimento**  
4 scatti  
Movement  
4 click positions

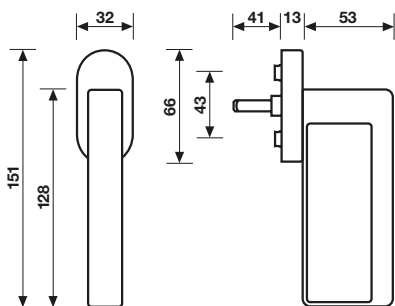

# K 358

Serie CA Duemiladue  
design Cerri & Associati

## Materiale Ottone

Material Brass

## Finiture Finishes

Cromo

Cromosat

## K 358

### Maniglione

Pull Handle

### Interasse / Centre distance

300 mm

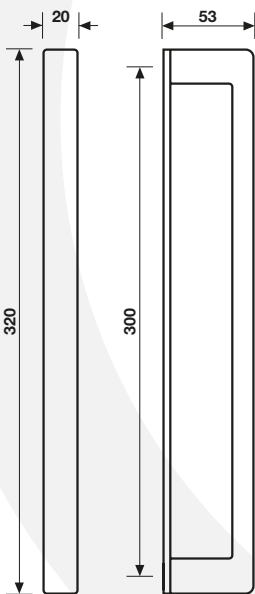

## K 383

**Materiale Ottone**  
Material Brass

**Finiture / Finishes**  
Cromo  
Cromosat

**Bocchetta**  
Escutcheon

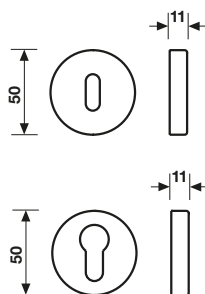

**K 383**  
Foro chiave normale  
Standard hole  
escutcheon

**K 383 Y**  
Foro chiave cilindro  
Euro-profile hole  
escutcheon

## K 3703 CP

**Materiale Ottone**  
Material Brass

**Finiture / Finishes**  
Cromo  
Cromosat

**Bocchetta per RG8**  
Escutcheon for RG8

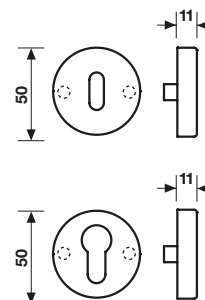

**K 3703 CP**  
Foro chiave normale  
Standard hole  
escutcheon

**K 3703 Y CP**  
Foro chiave cilindro  
Euro-profile hole  
escutcheon

## K 3037

**Materiale Ottone**  
Material Brass

**Finiture / Finishes**  
Cromo  
Cromosat

**Bocchetta stretta**  
Narrow Escutcheon

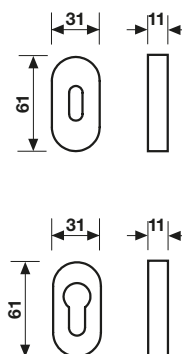

**K 3037**  
Foro chiave normale  
Standard hole  
escutcheon

**K 3037 Y**  
Foro chiave cilindro  
Euro-profile hole  
escutcheon

## K 382 50

**Materiale Ottone**  
Material Brass

**Finiture / Finishes**  
Cromo  
Cromosat

**Chiusura privacy BZG**  
Bathroom privacy set

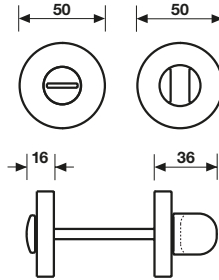

**K 382 R6-7-8 50 BZG - 85**



**K 382 RS6-7-8 50 BZG - 85**



## K 389 RG8

**Materiale Ottone**  
Material Brass

**Finiture / Finishes**  
Cromo  
Cromosat

**Chiusura privacy BZG per RG8**  
Bathroom privacy set for RG8

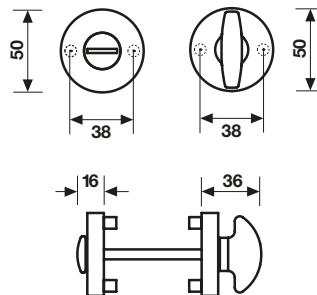

**K 389 RG6-7-8 50 BZG - 75**





# H 315

Serie G Novanta  
design Pierluigi Cerri

**Maniglia per porta**  
Door handle

**Materiale Ottone e porcellana**  
Material Brass and Porcelain

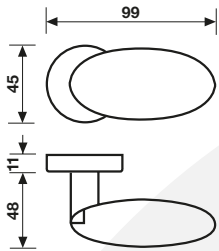

## Finiture

Finishes



Cromo



Oro lucido



## H 315 FRS-41

**Maniglia per finestra**  
Window handle

**Movimento**  
4 scatti  
Movement  
4 click positions

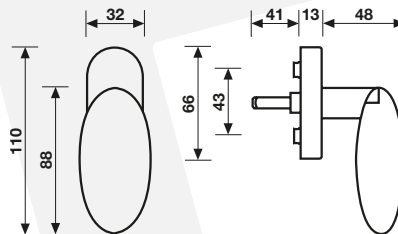

### H 315 R7 / R8

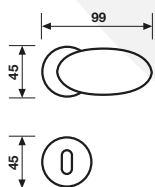

### H 315 R7 Y / R8 Y

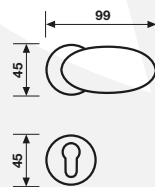

### H 315 RG8 / 8.5

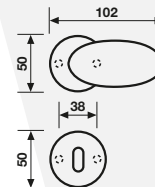

### H 315 RG8 / 8.5 Y

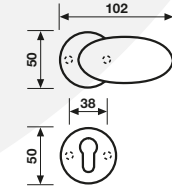

### H 315 RG6-7-8 BZG

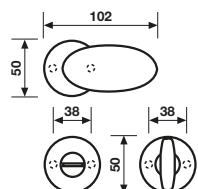

### H 315 RP Passage

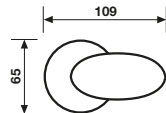

### H 315 RP Privacy

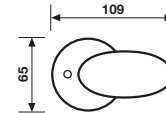

### H 315 RSB



## K 387

**Materiale Ottone**  
Material Brass

**Finiture / Finishes**  
Cromo  
Orolucido

**Bocchetta**  
Escutcheon

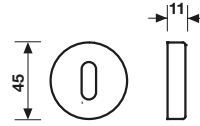

**K 387**  
Foro chiave normale  
Standard hole  
escutcheon

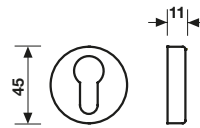

**K 387 Y**  
Foro chiave cilindro  
Euro-profile hole  
escutcheon

## K 3703 CP

**Materiale Ottone**  
Material Brass

**Finiture / Finishes**  
Cromo  
Orolucido

**Bocchetta per RG8**  
Escutcheon for RG8

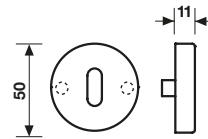

**K 3703 CP**  
Foro chiave normale  
Standard hole  
escutcheon

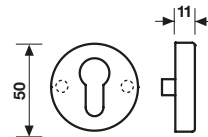

**K 3703 Y CP**  
Foro chiave cilindro  
Euro-profile hole  
escutcheon

## K 3037

**Materiale Ottone**  
Material Brass

**Finiture / Finishes**  
Cromo  
Orolucido

**Bocchetta stretta**  
Narrow Escutcheon

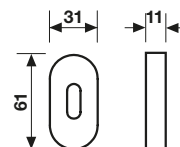

**K 3037**  
Foro chiave normale  
Standard hole  
escutcheon

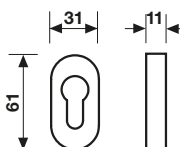

**K 3037 Y**  
Foro chiave cilindro  
Euro-profile hole  
escutcheon

## K 382

**Materiale Ottone**  
Material Brass

**Finiture / Finishes**  
Cromo  
Orolucido

**Chiusura privacy BZG**  
Bathroom privacy set

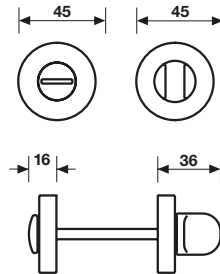

**K 382 R6-7-8 BZG - 85**



**K 382 RS6-7-8 BZG - 85**



## K 389 RG8

**Materiale Ottone**  
Material Brass

**Finiture / Finishes**  
Cromo  
Orolucido

**Chiusura privacy BZG per RG8**  
Bathroom privacy set for RG8

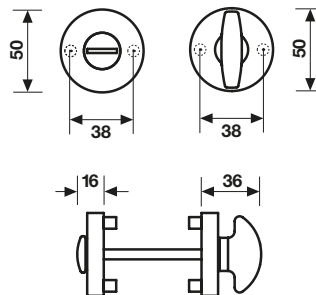

**K 389 RG6-7-8 50 BZG - 75**





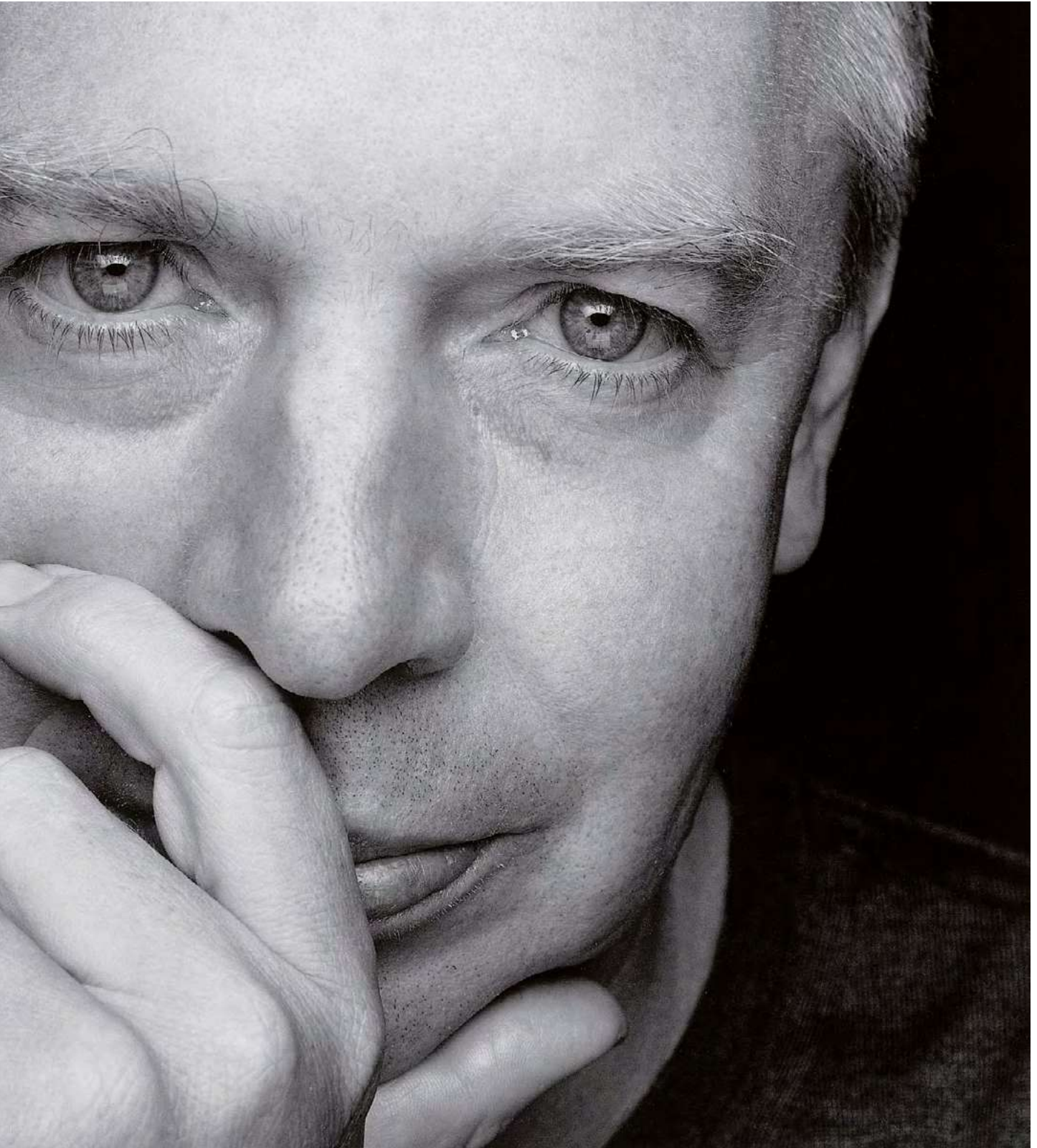

**David Chipperfield (1953) ha studiato alla Scuola d'Arte Kingston e alla Architectural Association di Londra e successivamente ha lavorato con Richard Rogers e Norman Foster. Nel 1985 ha fondato la David Chipperfield Architects di Londra e ha aperto ulteriori studi a Berlino, Milano e Shanghai. Chipperfield ha insegnato e tenuto conferenze in tutto il mondo. Nel 2009 è stato insignito dell'Ordine al Merito della Repubblica Federale di Germania e nel 2010 fu nominato cavaliere per i servizi dell'architettura nel Regno Unito e in Germania. Nel 2012 David Chipperfield è stato curatore della 13° Mostra Internazionale di Architettura della Biennale di Venezia.**

---

Sir David Chipperfield (1953) studied at Kingston School of Art and the Architectural Association in London and subsequently worked with Richard Rogers and Norman Foster. In 1985 he established David Chipperfield Architects in London and opened further practices in Berlin, Milan and Shanghai. Chipperfield has taught and lectured worldwide. In 2009 he was awarded the Order of Merit of the Federal Republic of Germany and in 2010 he was knighted for services to architecture in the UK and Germany. In 2012 David Chipperfield was Curator of the 13th International Architecture Exhibition of the Venice Biennale.



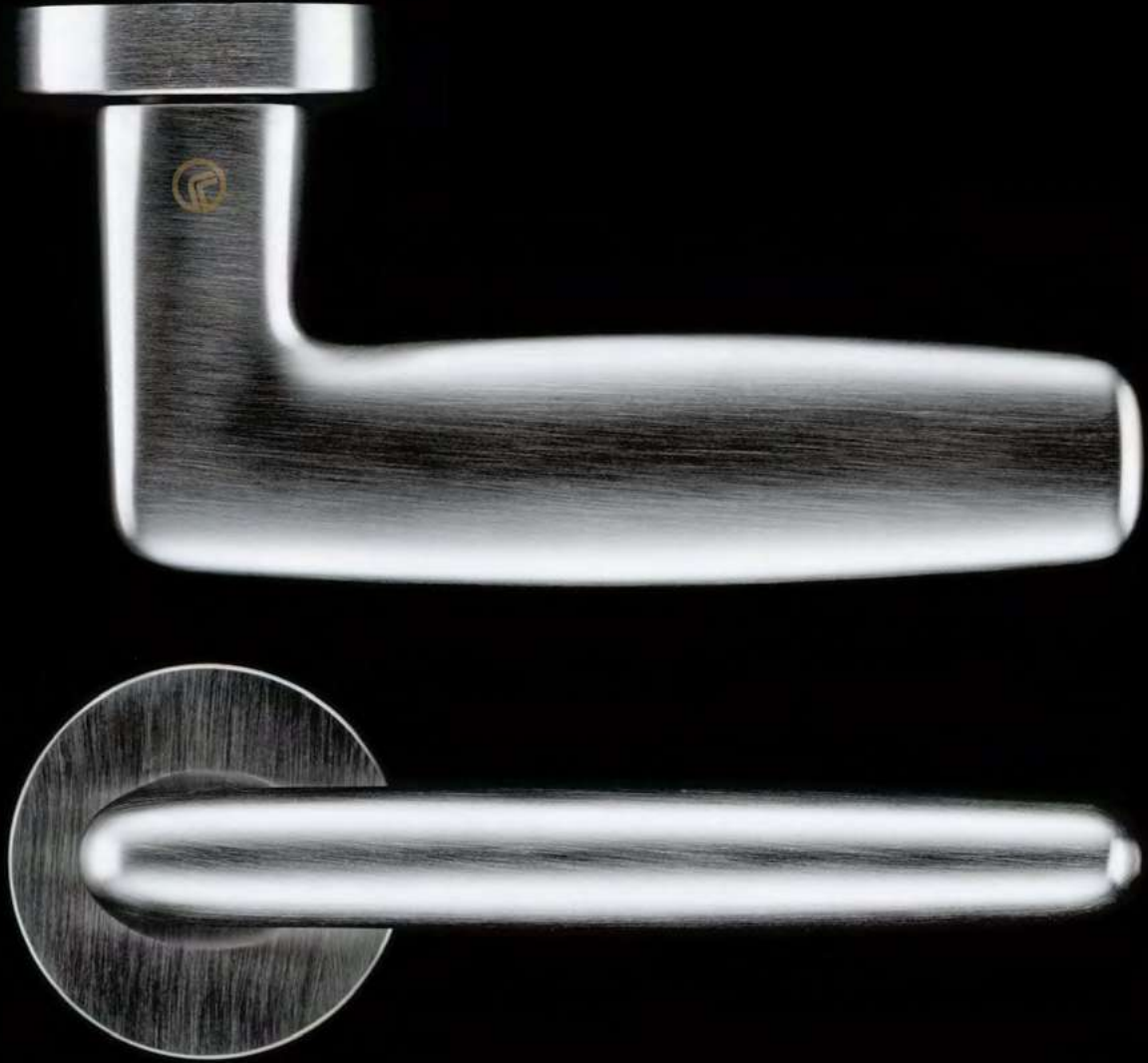

# H 363

Serie DC Duemilanove  
design David Chipperfield

**Maniglia per porta**  
Door handle

**Materiale Ottone**  
Material Brass

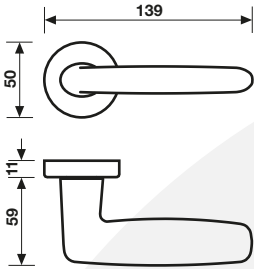

## Finiture

Finishes



Cromo



Cromosat

## H 363 FRS-41

**Maniglia per finestra**  
Window handle

**Movimento**  
4 scatti  
Movement  
4 click positions

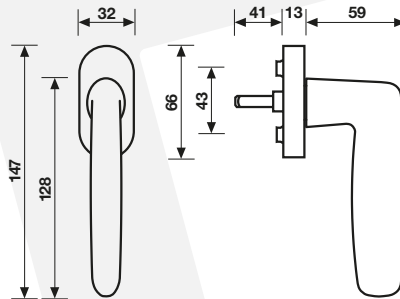

Disponibile anche CLASSE 4 su R8 / RG8  
secondo la norma DIN EN 1906 - Digit 4 7 - 0 1 - 0 B  
Available also CLASS 4 on R8 / RG8  
according to the DIN Standard EN 1906 - Digit 4 7 - 0 1 - 0 B

### H 363 R7 / R8

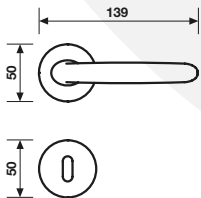

### H 363 R7 Y / R8 Y

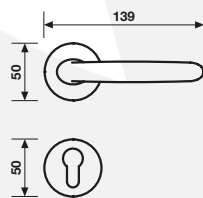

### H 363 RG8 / 8.5

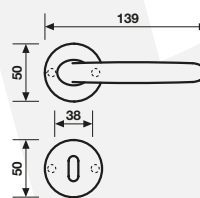

### H 363 RG8 / 8.5 Y

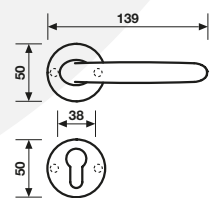

### H 363 RG6-7-8 BZG

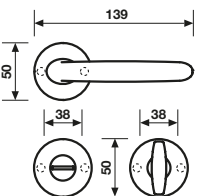

### H 363 RP Passage

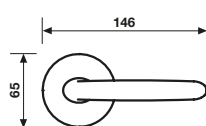

### H 363 RP Privacy

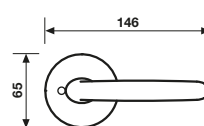

### H 363 RSB

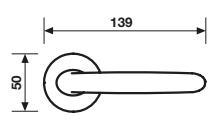

## K 383

**Materiale Ottone**  
Material Brass

**Finiture / Finishes**  
Cromo  
Cromosat

**Bocchetta**  
Escutcheon

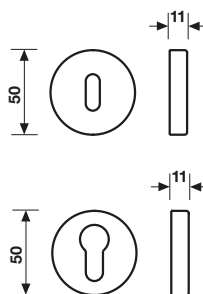

**K 383**  
Foro chiave normale  
Standard hole  
escutcheon

**K 383 Y**  
Foro chiave cilindro  
Euro-profile hole  
escutcheon

## K 3703 CP

**Materiale Ottone**  
Material Brass

**Finiture / Finishes**  
Cromo  
Cromosat

**Bocchetta per RG8**  
Escutcheon for RG8

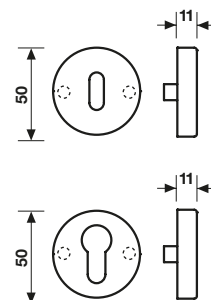

**K 3703 CP**  
Foro chiave normale  
Standard hole  
escutcheon

**K 3703 Y CP**  
Foro chiave cilindro  
Euro-profile hole  
escutcheon

## K 3037

**Materiale Ottone**  
Material Brass

**Finiture / Finishes**  
Cromo  
Cromosat

**Bocchetta stretta**  
Narrow Escutcheon

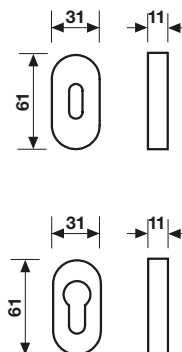

**K 3037**  
Foro chiave normale  
Standard hole  
escutcheon

**K 3037 Y**  
Foro chiave cilindro  
Euro-profile hole  
escutcheon

## K 382 50

**Materiale Ottone**  
Material Brass

**Finiture / Finishes**  
Cromo  
Cromosat

**Chiusura privacy BZG**  
Bathroom privacy set

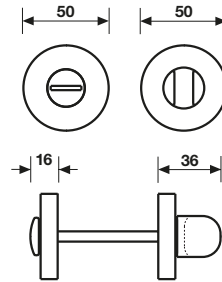

**K 382 R6-7-8 50 BZG - 85**



**K 382 RS6-7-8 50 BZG - 85**



## K 389 RG8

**Materiale Ottone**  
Material Brass

**Finiture / Finishes**  
Cromo  
Cromosat

**Chiusura privacy BZG per RG8**  
Bathroom privacy set for RG8

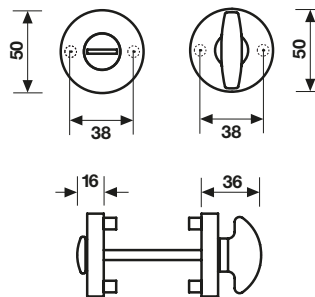

**K 389 RG6-7-8 50 BZG - 75**





# H 348

Serie DC Duemiladue  
design David Chipperfield

**Maniglia per porta**  
Door handle

**Materiale Ottone**  
Material Brass

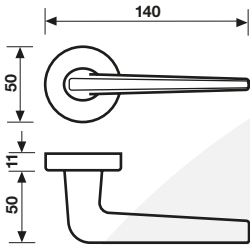

## Finiture

Finishes



Cromo



Cromosat



Disponibile anche CLASSE 4 su R8 / RG8  
secondo la norma DIN EN 1906 - Digit 4 7 - 0 1 - 0 B  
Available also CLASS 4 on R8 / RG8  
according to the DIN Standard EN 1906 - Digit 4 7 - 0 1 - 0 B

## H 348 FRS-41

**Maniglia per finestra**  
Window handle

**Movimento**  
4 scatti  
Movement  
4 click positions

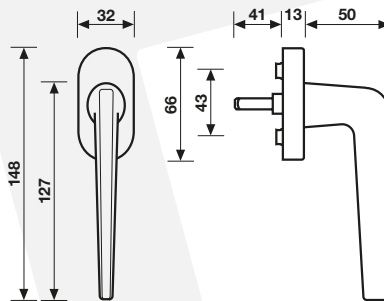

### H 348 R7 / R8

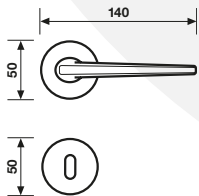

### H 348 R7 Y / R8 Y

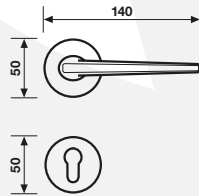

### H 348 RG8 / 8.5

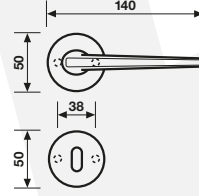

### H 348 RG8 / 8.5 Y

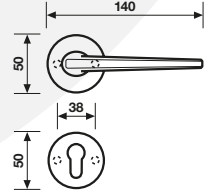

### H 348 RG6-7-8 BZG

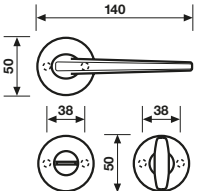

### H 348 RP Passage

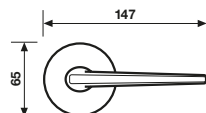

### H 348 RP Privacy

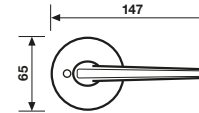

### H 348 RSB

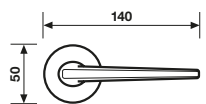



## K 383

**Materiale Ottone**  
Material Brass

**Finiture / Finishes**  
Cromo  
Cromosat

**Bocchetta**  
Escutcheon

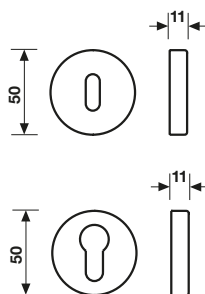

**K 383**  
Foro chiave normale  
Standard hole  
escutcheon

**K 383 Y**  
Foro chiave cilindro  
Euro-profile hole  
escutcheon

## K 3703 CP

**Materiale Ottone**  
Material Brass

**Finiture / Finishes**  
Cromo  
Cromosat

**Bocchetta per RG8**  
Escutcheon for RG8

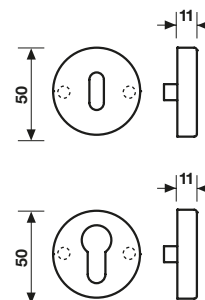

**K 3703 CP**  
Foro chiave normale  
Standard hole  
escutcheon

**K 3703 Y CP**  
Foro chiave cilindro  
Euro-profile hole  
escutcheon

## K 3037

**Materiale Ottone**  
Material Brass

**Finiture / Finishes**  
Cromo  
Cromosat

**Bocchetta stretta**  
Narrow Escutcheon

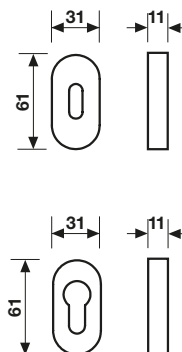

**K 3037**  
Foro chiave normale  
Standard hole  
escutcheon

**K 3037 Y**  
Foro chiave cilindro  
Euro-profile hole  
escutcheon

## K 382 50

**Materiale Ottone**  
Material Brass

**Finiture / Finishes**  
Cromo  
Cromosat

**Chiusura privacy BZG**  
Bathroom privacy set

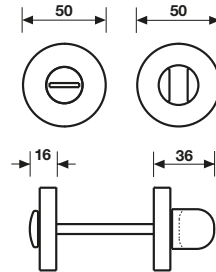

**K 382 R6-7-8 50 BZG - 85**



**K 382 RS6-7-8 50 BZG - 85**



## K 389 RG8

**Materiale Ottone**  
Material Brass

**Finiture / Finishes**  
Cromo  
Cromosat

**Chiusura privacy BZG per RG8**  
Bathroom privacy set for RG8

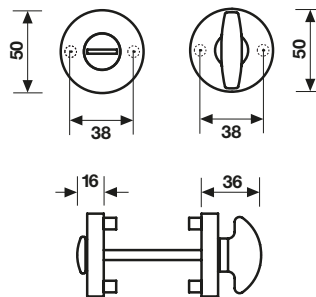

**K 389 RG6-7-8 50 BZG - 75**



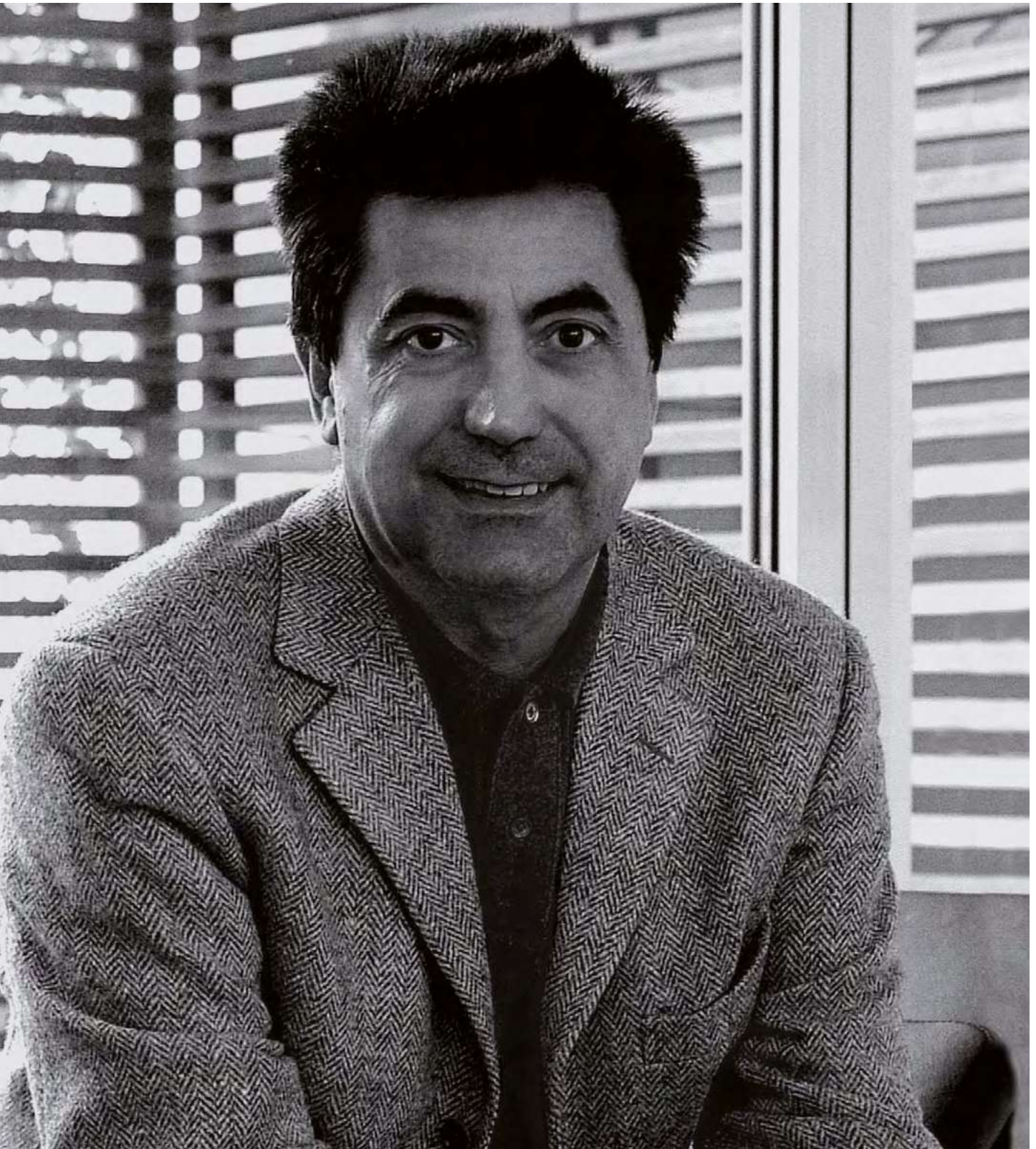

**Antonio Citterio nasce a Meda nel 1950, apre il proprio studio di progettazione nel 1972 e si laurea in architettura al Politecnico di Milano nel 1975. Fra il 1987 e il 1996 è associato a Terry Dwan; nel 1999 fonda con Patricia Viel la società “Antonio Citterio and Partners”. Lo studio opera a livello internazionale sviluppando programmi progettuali complessi, ad ogni scala ed in sinergia con un network qualificato di consulenze specialistiche. Antonio Citterio collabora attualmente, nel settore del disegno industriale, con aziende italiane e straniere quali Ansorg, Arclinea, Axor-Hansgrohe, B&B Italia, Flexform, Flos, Fusital, Hermès, Litala, Inda, Kartell, Maxalto, Sanitec Group - Pozzi Ginori, Technogym, Tre Più e Vitra.**

---

Antonio Citterio was born in Meda in 1950, started his design office in 1972, and graduated in architecture at the Milan Polytechnic in 1975. Between 1987 and 1996 he worked in association with Terry Dwan and in 1999, with Patricia Viel, he founded “Antonio Citterio and Partners”. The firm operates at international level developing complex long-term projects, at all scales and in synergy with a qualified network of specialist consultants. Antonio Citterio is currently working in the industrial design sector with Italian and foreign companies such as Ansorg, Arclinea, Axor-Hansgrohe, B&B Italia, Flexform, Flos, Fusital, Hermès, Litala, Inda, Kartell, Maxalto, Sanitec Group - Pozzi Ginori, Technogym, Tre Più and Vitra.



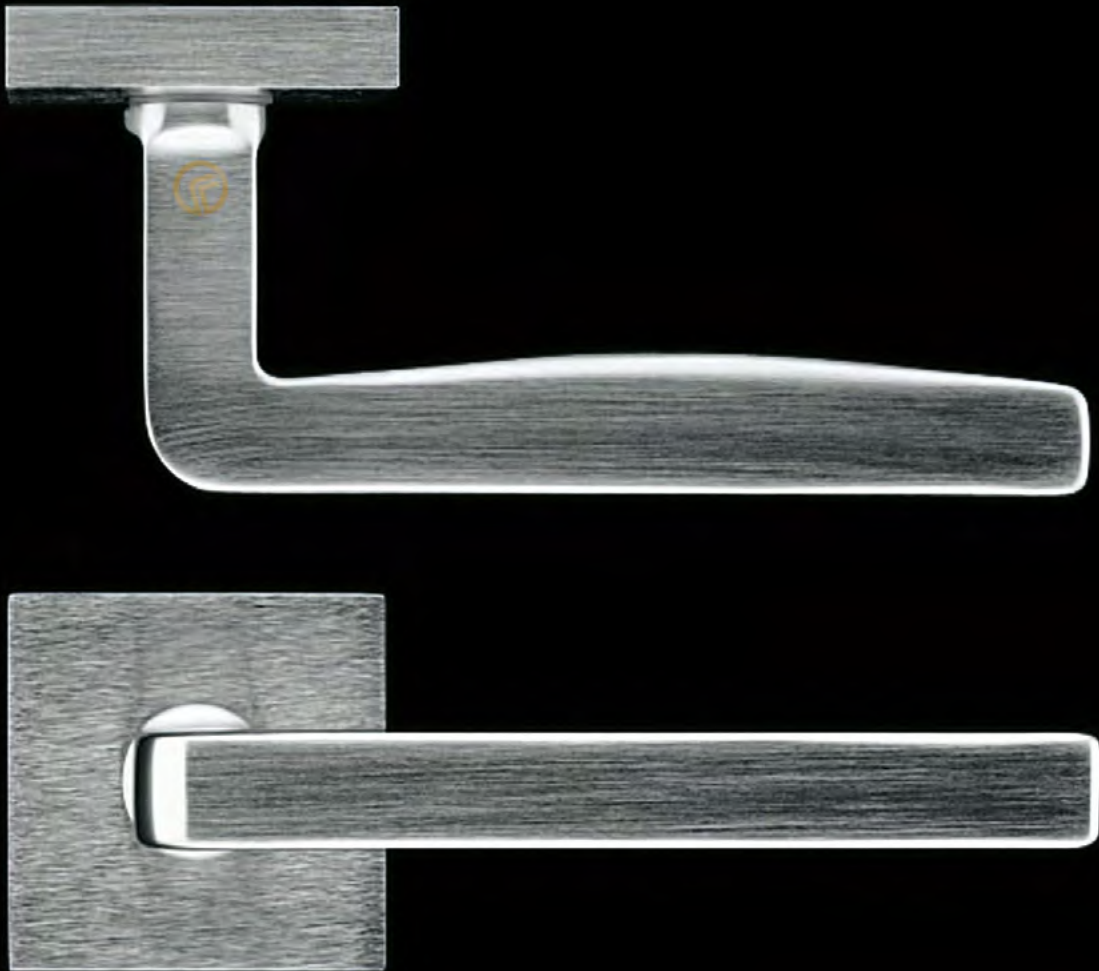

# H 361

Serie AC 4 Duemilasei

design Antonio Citterio con Toan Nguyen

## Maniglia per porta

Door handle

**Materiale Nikrall Lega Zama UNI 3717**

Material Nikrall Lega Zama UNI 3717

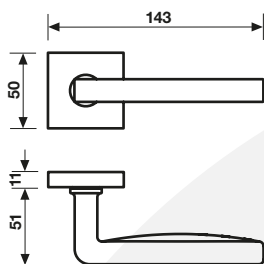

## Finiture

Finishes



Cromo



Light black



Cromosat



### H 361 R7 / R8

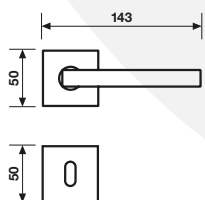

### H 361 R7 Y / R8 Y

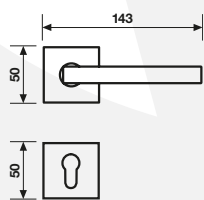

### H 361 RG8 / 8.5

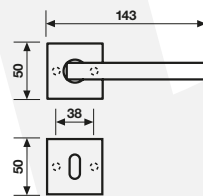

### H 361 RG8 / 8.5 Y

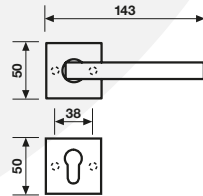

### H 361 RG6-7-8 BZG

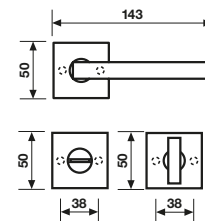

### H 361 RP Passage

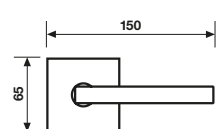

### H 361 RP Privacy

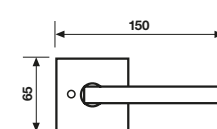

### H 361 RSB

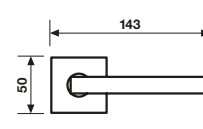

**Materiale Nikrall Lega Zama UNI 3717**  
Material Nikrall Lega Zama UNI 3717

**Finiture Finishes**  
Cromo  
Cromosat  
Light black

## H 361 FRS-41

**Maniglia per finestra**  
Window handle

**Movimento**  
4 scatti  
Movement  
4 click positions

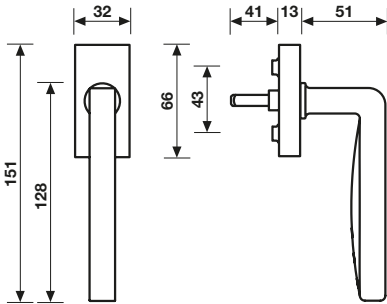

# K 368

Serie AC 4 Duemilasei

design Antonio Citterio con Toan Nguyen

## Materiale Ottone

Material Brass

## Finiture Finishes

Cromo

Cromosat

Light black

## K 368

### Maniglione

Pull Handle

### Interasse / Centre distance

300 mm

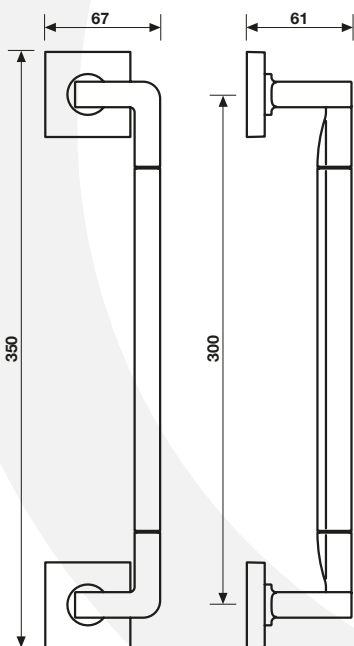



## K 3033

**Bocchetta**  
Escutcheon



**Materiale Nikrall Lega Zama UNI 3717**  
Material Nikrall Lega Zama UNI 3717

**Finiture / Finishes**  
Cromo  
Cromosat

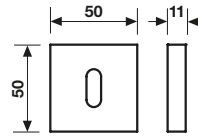

**K 3033**  
Foro chiave normale  
Standard hole  
escutcheon

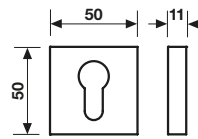

**K 3033 Y**  
Foro chiave cilindro  
Euro-profile hole  
escutcheon

## K 3033 CP

**Bocchetta per RG8**  
Escutcheon for RG8



**Materiale Nikrall Lega Zama UNI 3717**  
Material Nikrall Lega Zama UNI 3717

**Finiture / Finishes**  
Cromo  
Cromosat

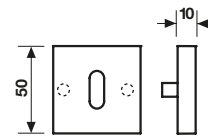

**K 3033 CP**  
Foro chiave normale  
Standard hole  
escutcheon

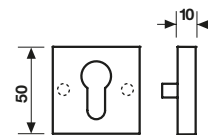

**K 3033 CP Y**  
Foro chiave cilindro  
Euro-profile hole  
escutcheon

## K 3038

**Bocchetta stretta**  
Narrow Escutcheon

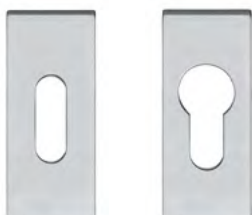

**Materiale Ottone**  
Material Brass

**Finiture / Finishes**  
Cromo  
Cromosat  
Light black

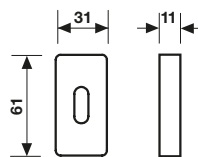

**K 3038**  
Foro chiave normale  
Standard hole  
escutcheon

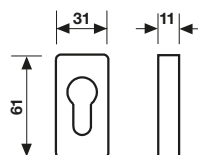

**K 3038 Y**  
Foro chiave cilindro  
Euro-profile hole  
escutcheon

## K 3020

**Materiale Nikrall Lega Zama UNI 3717**  
 Material Nikrall Lega Zama UNI 3717

**Finiture / Finishes**  
 Cromo  
 Cromosat

**Chiusura privacy BZG**  
 Bathroom privacy set

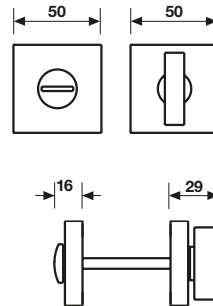

**K 3020 R6-7-8 50 BZG - 85**



## K 3020 RG8

**Materiale Nikrall Lega Zama UNI 3717**  
 Material Nikrall Lega Zama UNI 3717

**Finiture / Finishes**  
 Cromo  
 Cromosat  
 Light black

**Chiusura privacy BZG per RG8**  
 Bathroom privacy set for RG8

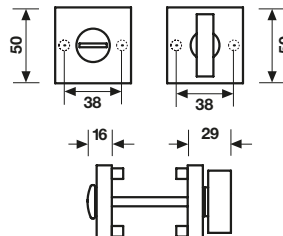

**K 3020 RG6-7-8 50 BZG - 85**





# H 327

Serie AC 2 Novantacinque  
design Antonio Citterio

**Maniglia per porta**  
Door handle

**Materiale Ottone**  
Material Brass

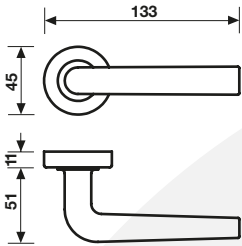

## Finiture

Finishes



Cromosat



Oro lucido



Disponibile anche CLASSE 4 su R8 / RG8  
secondo la norma DIN EN 1906 - Digit 4 7 - 01 - 0 B  
Available also CLASS 4 on R8 / RG8  
according to the DIN Standard EN 1906 - Digit 4 7 - 01 - 0 B

## H 327 FRS-41

**Maniglia per finestra**  
Window handle

**Movimento**  
4 scatti  
Movement  
4 click positions

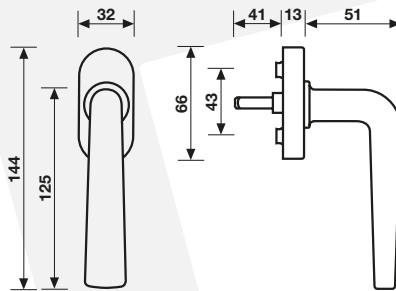

### H 327 R7 / R8

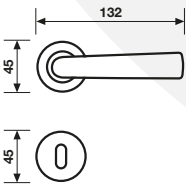

### H 327 R7 Y / R8 Y

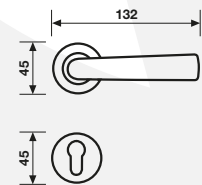

### H 327 RG8 / 8.5

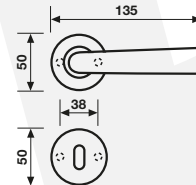

### H 327 RG8 / 8.5 Y

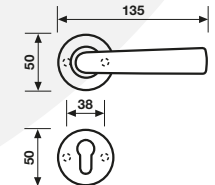

### H 327 RG6-7-8 BZG

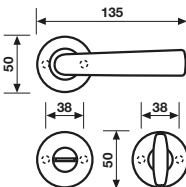

### H 327 RP Passage

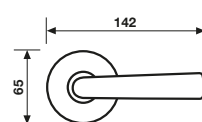

### H 327 RP Privacy

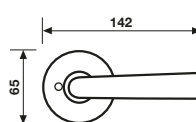

### H 327 RSB

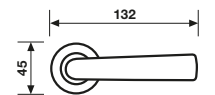

## K 387

**Materiale Ottone**  
Material Brass

**Finiture / Finishes**  
Cromosat  
Orolucido

**Bocchetta**  
Escutcheon

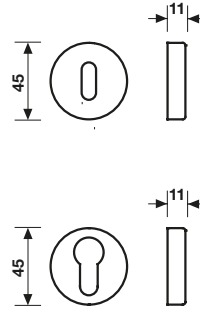

**K 387**  
Foro chiave normale  
Standard hole  
escutcheon

**K 387 Y**  
Foro chiave cilindro  
Euro-profile hole  
escutcheon

## K 3703 CP

**Materiale Ottone**  
Material Brass

**Finiture / Finishes**  
Cromosat  
Orolucido

**Bocchetta per RG8**  
Escutcheon for RG8

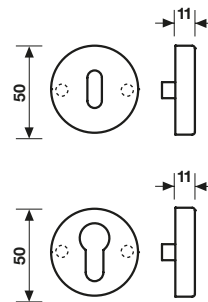

**K 3703 CP**  
Foro chiave normale  
Standard hole  
escutcheon

**K 3703 Y CP**  
Foro chiave cilindro  
Euro-profile hole  
escutcheon

## K 3037

**Materiale Ottone**  
Material Brass

**Finiture / Finishes**  
Cromosat  
Orolucido

**Bocchetta stretta**  
Narrow Escutcheon

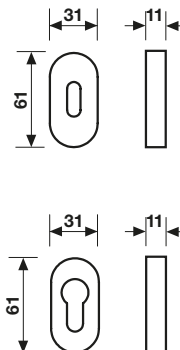

**K 3037**  
Foro chiave normale  
Standard hole  
escutcheon

**K 3037 Y**  
Foro chiave cilindro  
Euro-profile hole  
escutcheon

## K 382

**Materiale Ottone**  
Material Brass

**Finiture / Finishes**  
Cromosat  
Orolucido

**Chiusura privacy BZG**  
Bathroom privacy set

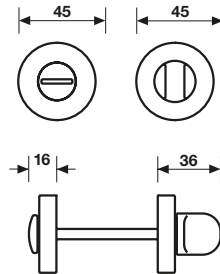

**K 382 R6-7-8 BZG - 85**



**K 382 RS6-7-8 BZG - 85**



## K 389 RG8

**Materiale Ottone**  
Material Brass

**Finiture / Finishes**  
Cromosat  
Orolucido

**Chiusura privacy BZG per RG8**  
Bathroom privacy set for RG8

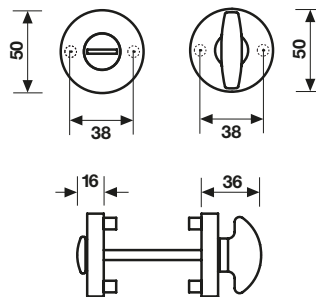

**K 389 RG6-7-8 50 BZG - 75**





# H 326

Serie AC 1 Novantacinque  
design Antonio Citterio

**Maniglia per porta**  
Door handle

**Materiale Ottone**  
Material Brass

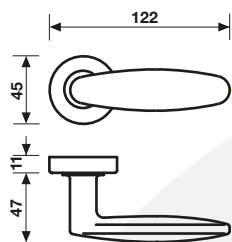

## Finiture

Finishes



Cromosat



Oro lucido



Disponibile anche CLASSE 4 su R8 / RG8  
secondo la norma DIN EN 1906 - Digit 4 7 - 0 1 - 0 B  
Available also CLASS 4 on R8 / RG8  
according to the DIN Standard EN 1906 - Digit 4 7 - 0 1 - 0 B

## H 326 FRS-41

**Maniglia per finestra**  
Window handle

**Movimento**  
4 scatti  
Movement  
4 click positions

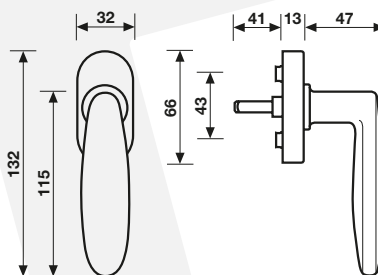

### H 326 R7 / R8

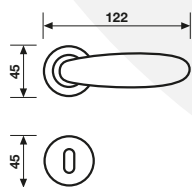

### H 326 R7 Y / R8 Y

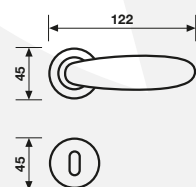

### H 326 RG8 / 8.5

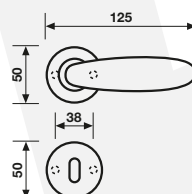

### H 326 RG8 / 8.5 Y

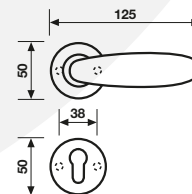

### H 326 RG6-7-8 BZG

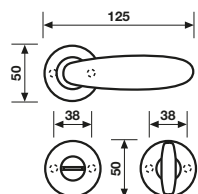

### H 326 RP Passage

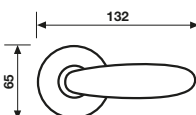

### H 326 RP Privacy

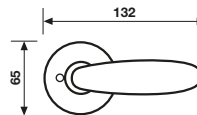

### H 326 RSB

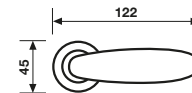



## K 387

**Materiale Ottone**  
Material Brass

**Finiture / Finishes**  
Cromosat  
Orolucido

**Bocchetta**  
Escutcheon

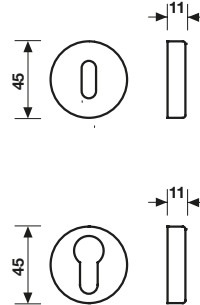

**K 387**  
Foro chiave normale  
Standard hole  
escutcheon

**K 387 Y**  
Foro chiave cilindro  
Euro-profile hole  
escutcheon

## K 3703 CP

**Materiale Ottone**  
Material Brass

**Finiture / Finishes**  
Cromosat  
Orolucido

**Bocchetta per RG8**  
Escutcheon for RG8

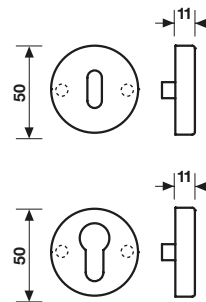

**K 3703 CP**  
Foro chiave normale  
Standard hole  
escutcheon

**K 3703 Y CP**  
Foro chiave cilindro  
Euro-profile hole  
escutcheon

## K 3037

**Materiale Ottone**  
Material Brass

**Finiture / Finishes**  
Cromosat  
Orolucido

**Bocchetta stretta**  
Narrow Escutcheon

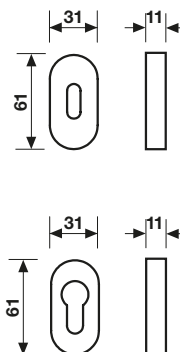

**K 3037**  
Foro chiave normale  
Standard hole  
escutcheon

**K 3037 Y**  
Foro chiave cilindro  
Euro-profile hole  
escutcheon

## K 382

**Materiale Ottone**  
Material Brass

**Finiture / Finishes**  
Cromosat  
Orolucido

**Chiusura privacy BZG**  
Bathroom privacy set

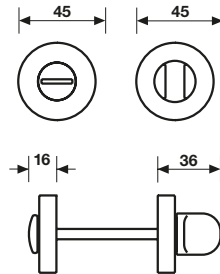

**K 382 R6-7-8 BZG - 85**



**K 382 RS6-7-8 BZG - 85**



## K 389 RG8

**Materiale Ottone**  
Material Brass

**Finiture / Finishes**  
Cromo  
Orolucido

**Chiusura privacy BZG per RG8**  
Bathroom privacy set for RG8

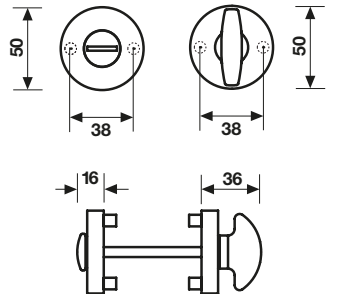

**K 389 RG6-7-8 50 BZG - 75**





# H 317

Serie AC Novantauno  
design Antonio Citterio

**Maniglia per porta**  
Door handle

**Materiale Ottone**  
Material Brass

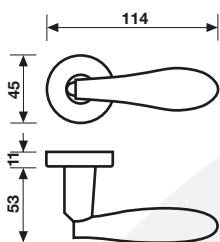

## Finiture

Finishes



Cromo



Orolucido



Cromosat



Disponibile anche CLASSE 4 su R8 / RG8  
secondo la norma DIN EN 1906 - Digit 4 7 - 01 - 0 B  
Available also CLASS 4 on R8 / RG8  
according to the DIN Standard EN 1906 - Digit 4 7 - 01 - 0 B

## H 317 FRS-41

**Maniglia per finestra**  
Window handle

**Movimento**  
4 scatti  
Movement  
4 click positions

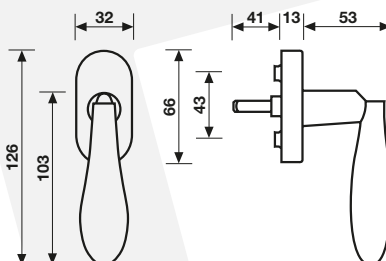

### H 317 R7 / R8

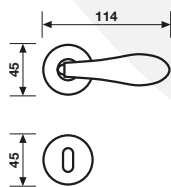

### H 317 R7 Y / R8 Y

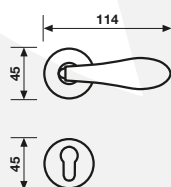

### H 317 RG8 / 8.5

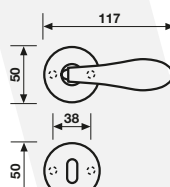

### H 317 RG8 / 8.5 Y

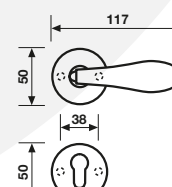

### H 317 RG6-7-8 BZG

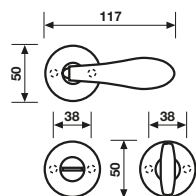

### H 317 RP Passage

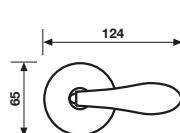

### H 317 RP Privacy

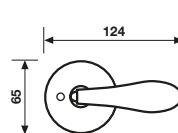

### H 317 RSB

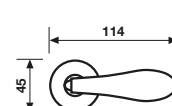

## K 387

**Bocchetta**  
Escutcheon



**Materiale Ottone**  
Material Brass

**Finiture / Finishes**  
Cromo  
Cromosat  
Orolucido

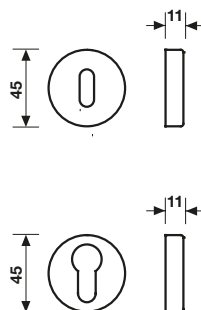

**K 387**  
Foro chiave normale  
Standard hole  
escutcheon

**K 387 Y**  
Foro chiave cilindro  
Euro-profile hole  
escutcheon

## K 3703 CP

**Bocchetta per RG8**  
Escutcheon for RG8



**Materiale Ottone**  
Material Brass

**Finiture / Finishes**  
Cromo  
Cromosat  
Orolucido

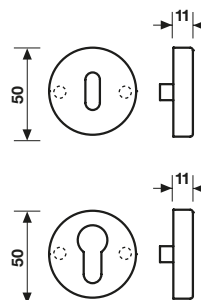

**K 3703 CP**  
Foro chiave normale  
Standard hole  
escutcheon

**K 3703 Y CP**  
Foro chiave cilindro  
Euro-profile hole  
escutcheon

## K 3037

**Bocchetta stretta**  
Narrow Escutcheon



**Materiale Ottone**  
Material Brass

**Finiture / Finishes**  
Cromo  
Cromosat  
Orolucido

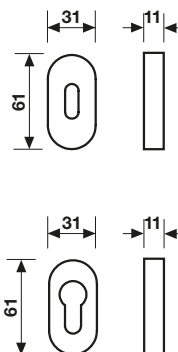

**K 3037**  
Foro chiave normale  
Standard hole  
escutcheon

**K 3037 Y**  
Foro chiave cilindro  
Euro-profile hole  
escutcheon

## K 382

**Materiale Ottone**  
Material Brass

**Finiture / Finishes**  
Cromo  
Cromosat  
Orolucido

**Chiusura privacy BZG**  
Bathroom privacy set

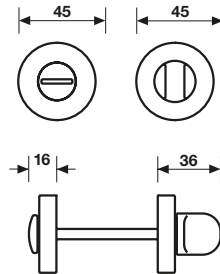

**K 382 R6-7-8 BZG - 85**



**K 382 RS6-7-8 BZG - 85**



## K 389 RG8

**Materiale Ottone**  
Material Brass

**Finiture / Finishes**  
Cromo  
Cromosat  
Orolucido

**Chiusura privacy BZG per RG8**  
Bathroom privacy set for RG8

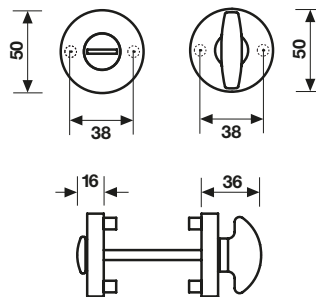

**K 389 RG6-7-8 50 BZG - 75**



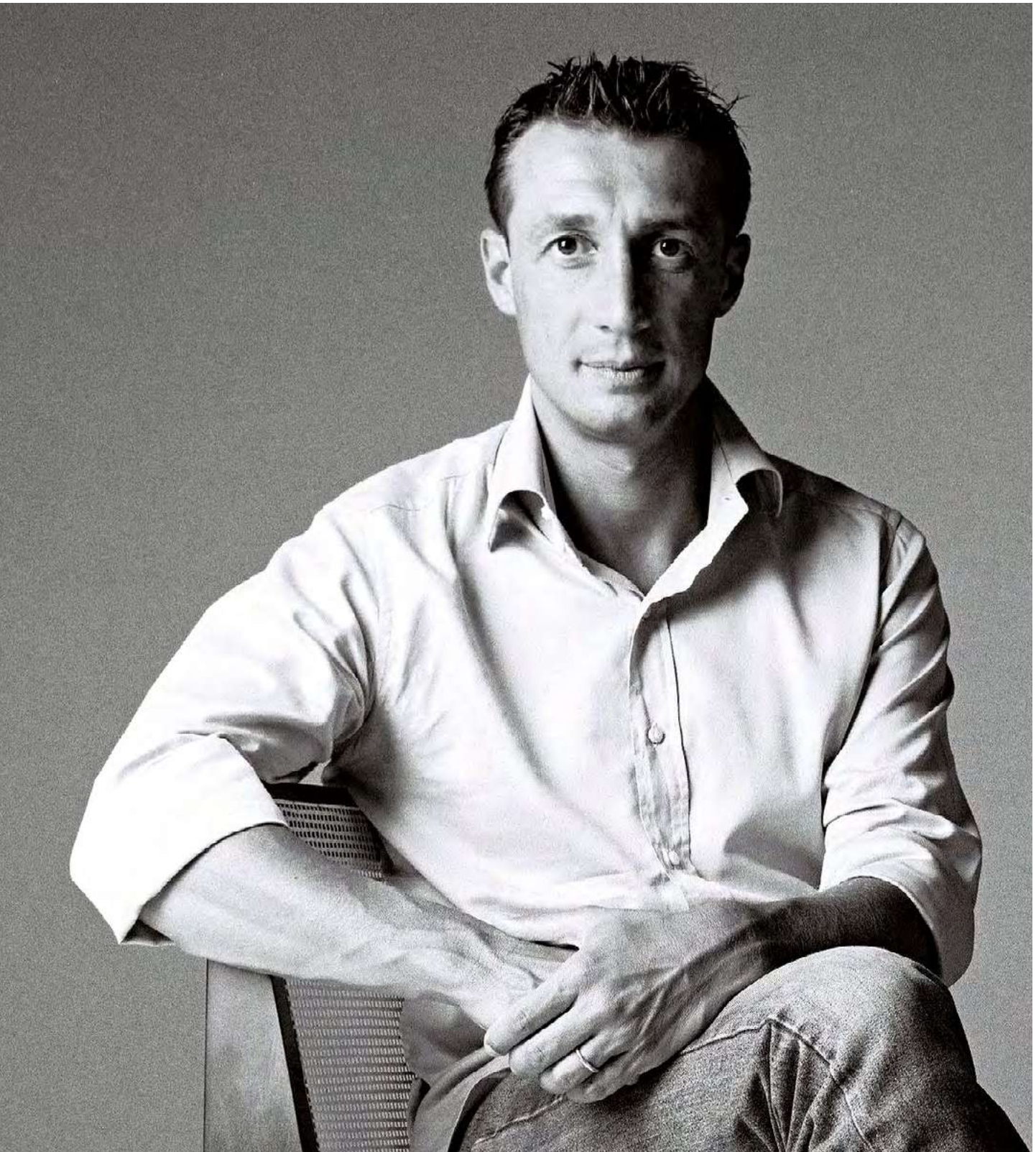

**Nel 1993 si laurea in Architettura presso il Politecnico di Milano. Nel 2004 è nominato designer dell'anno. Nel 2012 vince il Red Dot Design Award con il sistema "Hydroline" su vasca "Outline" di Teuco e nel 2013 vince l'Interior Innovation Award in occasione dell'IMM di Köln. Sorta di ambasciatore del design italiano, tiene lezioni e conferenze in tutto il mondo. Oltre al disegno di prodotti di arredo e design, si dedica per le aziende alla strategia e al marketing, elabora progetti grafici e cura mostre, lavora come consulente e come direttore artistico. Dal 2011 insegna presso la DeTao Academy di Beijing. Il suo studio si occupa di progetti a grande scala dal design all'interiors e a progetti di architettura.**

---

In 1993 Carlo Colombo graduated in Architecture from the Milan Polytechnic. In 2004 he was appointed Designer of the Year. In 2012 he received the Red Dot Design Award for his "Hydroline" system on the Teuco "Outline" bathtub and in 2013 he won the Interior Innovation Award at IMM Köln. He is considered a sort of ambassador of Italian design, he gives lectures all over the world. Besides developing design furniture products, he takes care of business and marketing strategies for several companies, works out graphic designs and curates exhibitions. He works also as a consultant and art director. Since 2011 he gives lectures at the De Tao Masters Academy in Beijing. Today, his practice works on large scale projects in the interior design and architectural field.





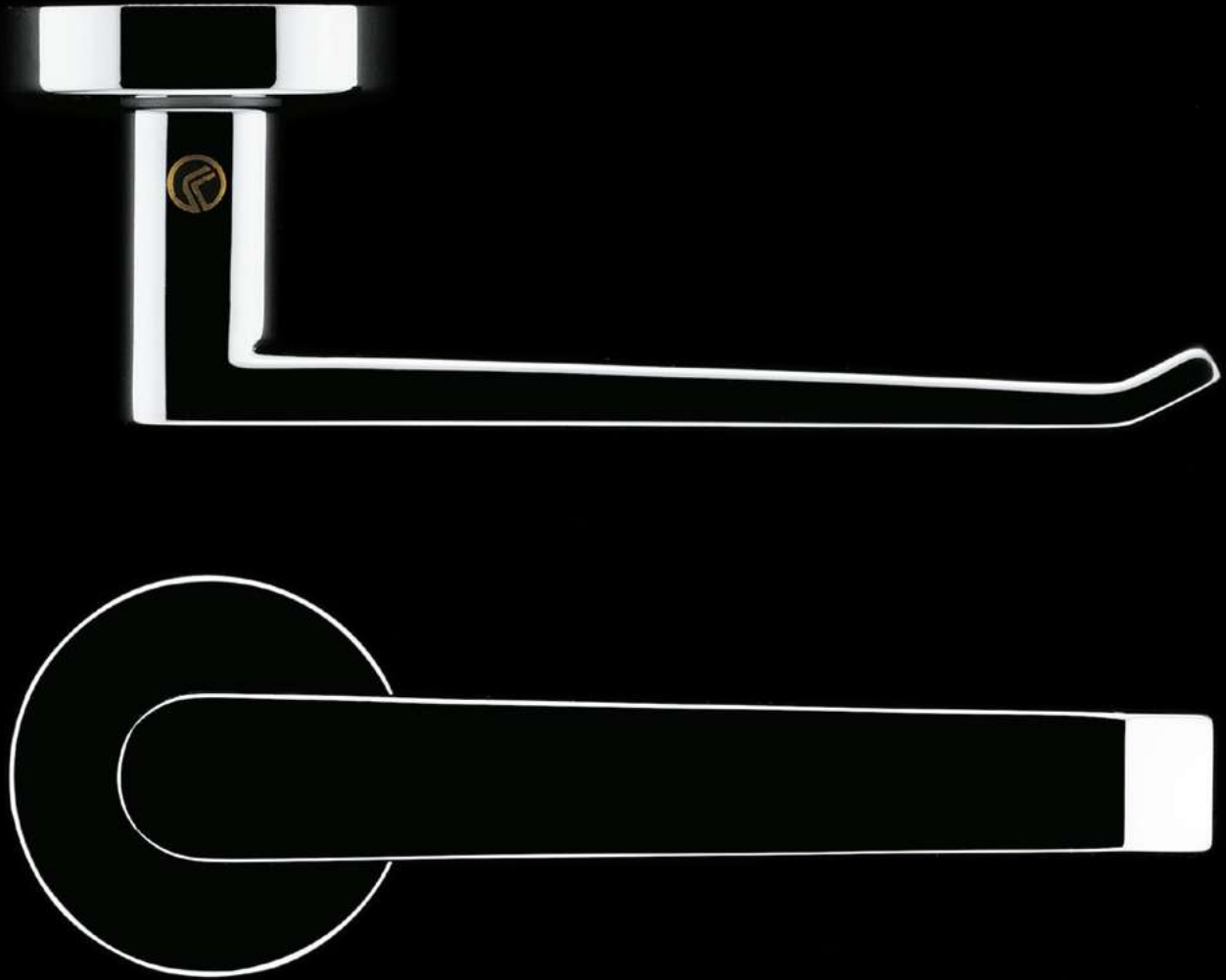

# H 362

Serie CC Duemilanove  
design Carlo Colombo

**Maniglia per porta**  
Door handle

**Materiale Ottone**  
Material Brass

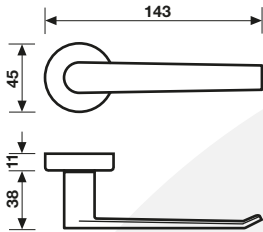

## Finiture

Finishes



Cromo



Cromosat



Disponibile anche CLASSE 4 su R8 / RG8  
secondo la norma DIN EN 1906 - Digit 4 7 - 01 - 0 B  
Available also CLASS 4 on R8 / RG8  
according to the DIN Standard EN 1906 - Digit 4 7 - 01 - 0 B

## H 362 FRS-41

**Maniglia per finestra**  
Window handle

**Movimento**  
4 scatti  
Movement  
4 click positions

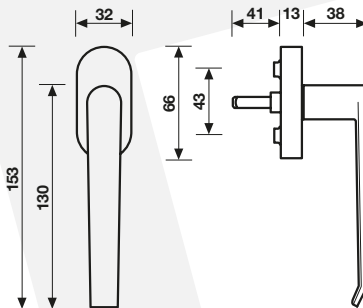

### H 362 R7 / R8

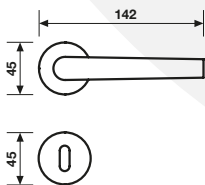

### H 362 R7 Y / R8 Y

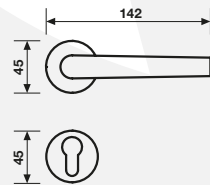

### H 362 RG8 / 8.5

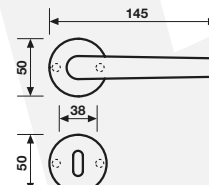

### H 362 RG8 / 8.5 Y

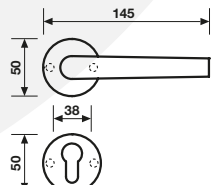

### H 362 RG6-7-8 BZG

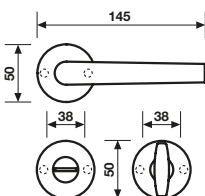

### H 362 RP Passage

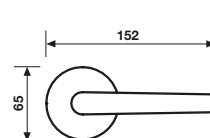

### H 362 RP Privacy

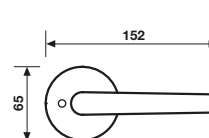

### H 362 RSB

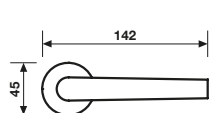

## K 387

**Materiale Ottone**  
Material Brass

**Finiture / Finishes**  
Cromo  
Cromosat

**Bocchetta**  
Escutcheon

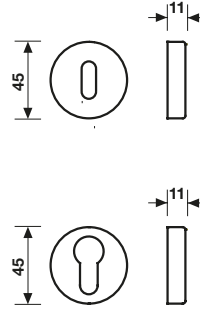

**K 387**  
Foro chiave normale  
Standard hole  
escutcheon

**K 387 Y**  
Foro chiave cilindro  
Euro-profile hole  
escutcheon

## K 3703 CP

**Materiale Ottone**  
Material Brass

**Finiture / Finishes**  
Cromo  
Cromosat

**Bocchetta per RG8**  
Escutcheon for RG8

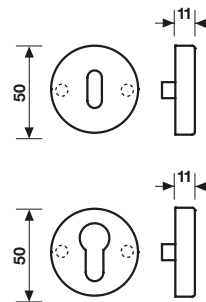

**K 3703 CP**  
Foro chiave normale  
Standard hole  
escutcheon

**K 3703 Y CP**  
Foro chiave cilindro  
Euro-profile hole  
escutcheon

## K 3037

**Materiale Ottone**  
Material Brass

**Finiture / Finishes**  
Cromo  
Cromosat

**Bocchetta stretta**  
Narrow Escutcheon

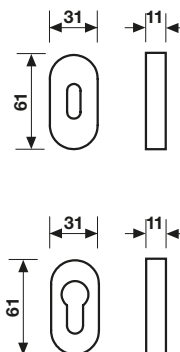

**K 3037**  
Foro chiave normale  
Standard hole  
escutcheon

**K 3037 Y**  
Foro chiave cilindro  
Euro-profile hole  
escutcheon

## K 382

**Materiale Ottone**  
Material Brass

**Finiture / Finishes**  
Cromo  
Cromosat

**Chiusura privacy BZG**  
Bathroom privacy set

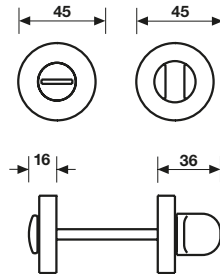

**K 382 R6-7-8 BZG - 85**



**K 382 RS6-7-8 BZG - 85**



## K 389 RG8

**Materiale Ottone**  
Material Brass

**Finiture / Finishes**  
Cromo  
Cromosat

**Chiusura privacy BZG per RG8**  
Bathroom privacy set for RG8

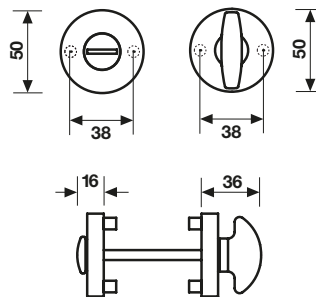

**K 389 RG6-7-8 50 BZG - 75**





**Odile Decq** fissa il suo ufficio subito dopo la laurea a La Villette nel 1978 e al Sciences Politiques Paris in Urban Planning nel 1979. La sua fama internazionale è cresciuta rapidamente già nel 1990 ODBC ha vinto il suo primo incarico importante, la Banque Populaire de l'Ouest a Rennes. ODBC è stata premiata con il Leone d'Oro a Venezia nel 1996. Autonoma dal 1998, Odile Decq è stata fedele al suo stile diversificando la sua ricerca. Ha realizzato il MACRO (Museo d'Arte Contemporanea di Roma) nel 2010, il ristorante Phantom in Opera Garnier di Parigi nel 2011 e il FRAC (Museo d'Arte Contemporanea di Rennes) nel luglio 2012.

---

Odile Decq set up her own office just after graduating at La Villette in 1978 and at Sciences Politiques Paris in Urban Planning in 1979. International renown came quickly as early as 1990 ODBC won their first major commission, the Banque Populaire de l'Ouest in Rennes. ODBC were awarded with a Golden Lion in Venice in 1996. Alone since 1998, Odile Decq has been faithful to her fighting attitude while diversifying her research. She has realized the MACRO (Museum for Contemporary Art in Rome) in 2010, the Phantom restaurant in Opera Garnier in Paris in 2011 and the FRAC (Museum of Contemporary Art in Rennes) July 2012.

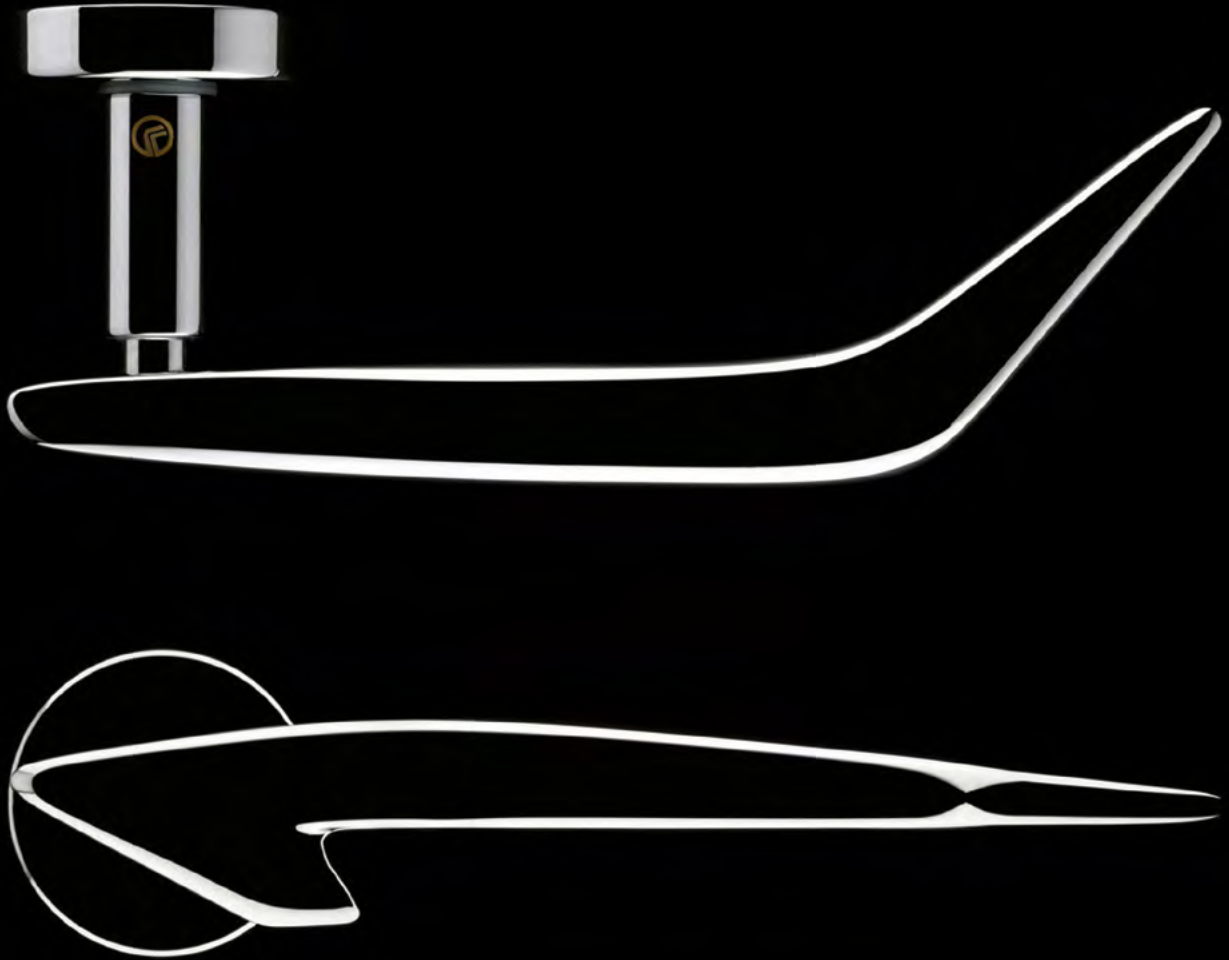

# H 352

Serie **ODBC Duemiladue**  
design Odile Decq Benoît Cornette

**Maniglia per porta**  
Door handle

**Materiale Ottone**  
Material Brass

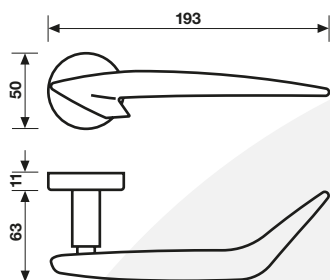

## Finiture

Finishes



Cromo



Cromosat

**H 352 R7 / R8**

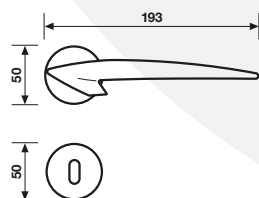

**H 352 R7 Y / R8 Y**

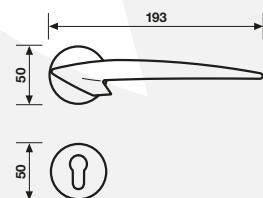

**H 352 RG8 / 8.5**

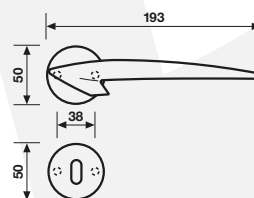

**H 352 RG8 / 8.5 Y**

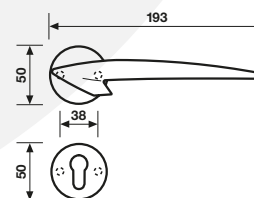

**H 352 RG6-7-8 BZG**

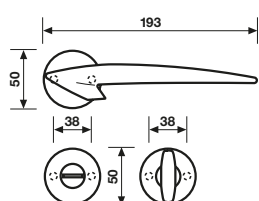

**H 352 RP Passage**

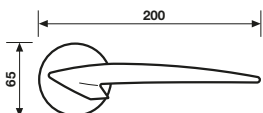

**H 352 RP Privacy**

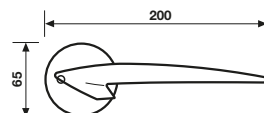

**H 352 RSB**

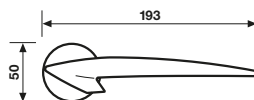



## K 383

**Materiale Ottone**  
Material Brass

**Finiture / Finishes**  
Cromo  
Cromosat

**Bocchetta**  
Escutcheon

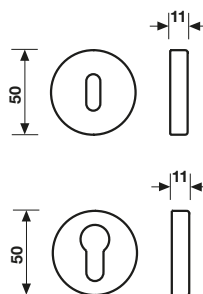

**K 383**  
Foro chiave normale  
Standard hole  
escutcheon

**K 383 Y**  
Foro chiave cilindro  
Euro-profile hole  
escutcheon

## K 3703 CP

**Materiale Ottone**  
Material Brass

**Finiture / Finishes**  
Cromo  
Cromosat

**Bocchetta per RG8**  
Escutcheon for RG8

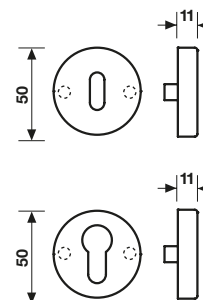

**K 3703 CP**  
Foro chiave normale  
Standard hole  
escutcheon

**K 3703 Y CP**  
Foro chiave cilindro  
Euro-profile hole  
escutcheon

## K 3037

**Materiale Ottone**  
Material Brass

**Finiture / Finishes**  
Cromo  
Cromosat

**Bocchetta stretta**  
Narrow Escutcheon

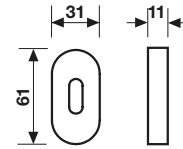

**K 3037**  
Foro chiave normale  
Standard hole  
escutcheon

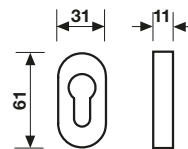

**K 3037 Y**  
Foro chiave cilindro  
Euro-profile hole  
escutcheon

## K 382 50

**Materiale Ottone**  
Material Brass

**Finiture / Finishes**  
Cromo  
Cromosat

**Chiusura privacy BZG**  
Bathroom privacy set

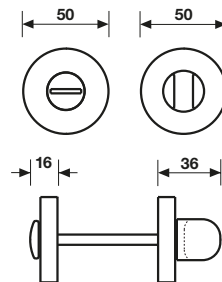

**K 382 R6-7-8 50 BZG - 85**



**K 382 RS6-7-8 50 BZG - 85**



## K 389 RG8

**Materiale Ottone**  
Material Brass

**Finiture / Finishes**  
Cromo  
Cromosat

**Chiusura privacy BZG per RG8**  
Bathroom privacy set for RG8

**K 389 RG6-7-8 50 BZG - 75**

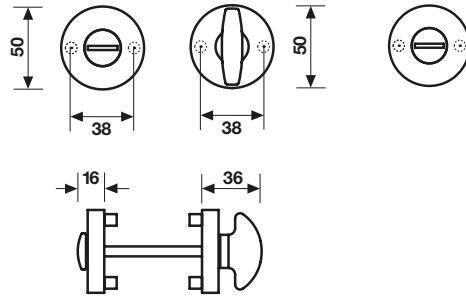

## K 359

**Materiale Ottone**  
Material Brass

**Finiture Finishes**  
Cromo  
Cromosat

**Maniglione**  
Pull Handle

**Interasse / Centre distance**  
300 mm

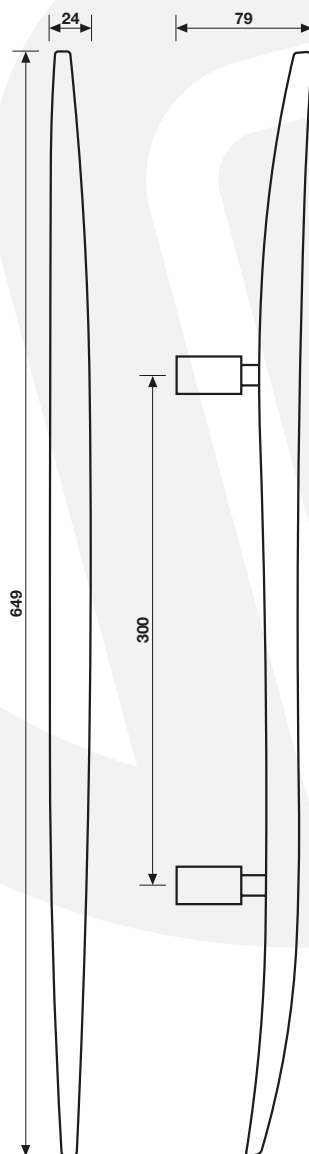



**Foster e Partners è una degli studi di architettura e progettazione più innovativi in tutto il mondo. Negli ultimi quattro decenni, lo studio è stato all'avanguardia di soluzioni integrate di progettazione sostenibile attraverso una vasta gamma di lavori, dai masterplan urbani, infrastrutture pubbliche, aeroporti, edifici civili e culturali, uffici e luoghi di lavoro per case private e produzioni di design. Con base a Londra, con studi in tutto il mondo, lo studio ha raggiunto il panorama internazionale, con strutture in sei continenti. Fin dalla sua istituzione nel 1967 ha ricevuto oltre 600 riconoscimenti per l'eccellenza e ha vinto più di 100 concorsi nazionali ed internazionali.**

---

Foster and Partners is one of the most innovative architecture and design practices in the world. Over the past four decades the practice has pioneered integrated, sustainable design solutions through a strikingly wide range of work, from urban masterplans, public infrastructure, airports, civic and cultural buildings, offices and workplaces to private houses and product design. Based in London, with studios worldwide, the practice has an international reach, with buildings on six continents. Since its inception in 1967 it has received more than 600 awards for excellence and won over 100 national and international competitions.

*MAN MAN F&P*

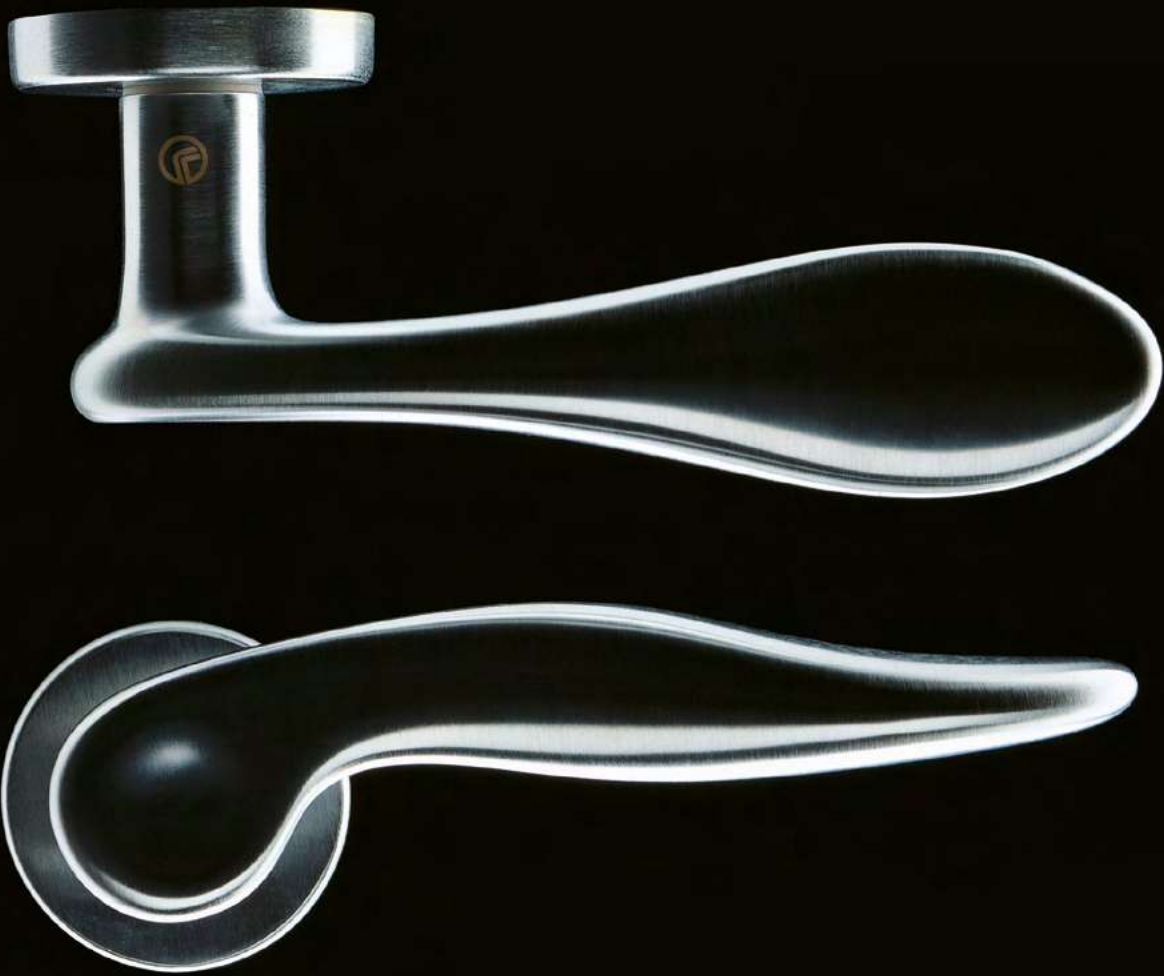

# H 334

Serie NF Novantotto  
design Foster and Partners

**Maniglia per porta**  
Door handle

**Materiale Ottone**  
Material Brass

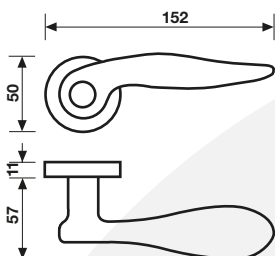

## Finiture

Finishes



Cromosat



Oro lucido



Disponibile anche CLASSE 4 su R8 / RG8  
secondo la norma DIN EN 1906 - Digit 4 7 - 0 1 - 0 B  
Available also CLASS 4 on R8 / RG8  
according to the DIN Standard EN 1906 - Digit 4 7 - 0 1 - 0 B

### H 334 R7 / R8

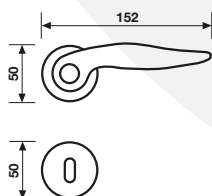

### H 334 R7 Y / R8 Y

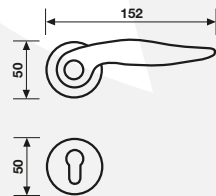

### H 334 RG8 / 8.5

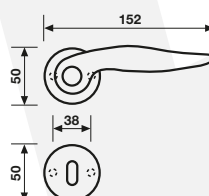

### H 334 RG8 / 8.5 Y

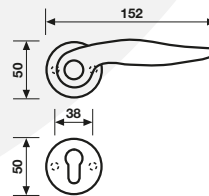

### H 334 RG6-7-8 BZG

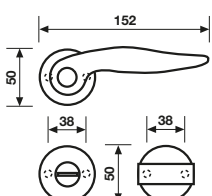

### H 334 RP Passage

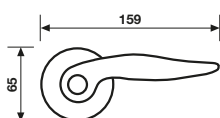

### H 334 RP Privacy

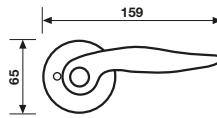

### H 334 RSB

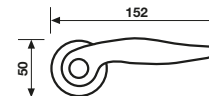



**Materiale Ottone**  
Material Brass

**Finiture Finishes**  
Cromosat  
Orolucido

## H 334 FRS-41

**Maniglia per finestra**  
Window handle

**Movimento**  
**4 scatti**  
Movement  
4 click positions

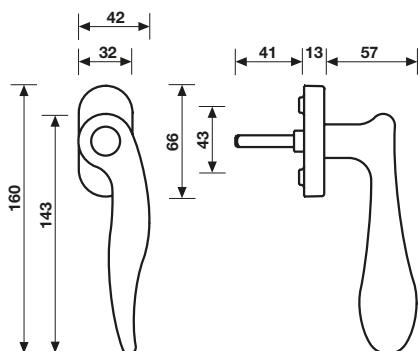

# K 354

Serie NF Novantotto  
design Foster and Partners

**Materiale Ottone / inox AISI 316L**  
Material Brass / Stainless steel AISI 316L

**Finiture** Finishes  
Nickelmatt/satinato

## K 354 / K 354 S

**Maniglione**  
Pull Handle

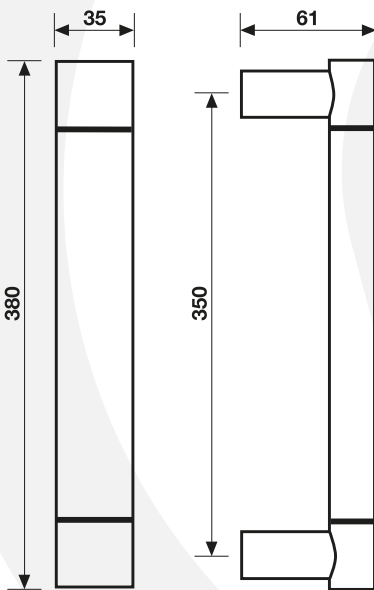

## K 383

**Materiale Ottone**  
Material Brass

**Finiture / Finishes**  
Cromosat  
Orolucido

**Bocchetta**  
Escutcheon

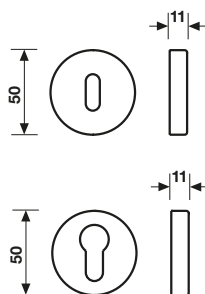

**K 383**  
Foro chiave normale  
Standard hole  
escutcheon

**K 383 Y**  
Foro chiave cilindro  
Euro-profile hole  
escutcheon

## K 3703 CP

**Materiale Ottone**  
Material Brass

**Finiture / Finishes**  
Cromosat  
Orolucido

**Bocchetta per RG8**  
Escutcheon for RG8

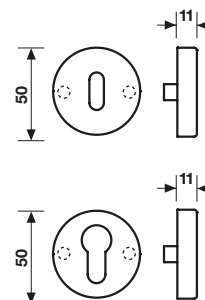

**K 3703 CP**  
Foro chiave normale  
Standard hole  
escutcheon

**K 3703 Y CP**  
Foro chiave cilindro  
Euro-profile hole  
escutcheon

## K 3037

**Materiale Ottone**  
Material Brass

**Finiture / Finishes**  
Cromosat  
Orolucido

**Bocchetta stretta**  
Narrow Escutcheon

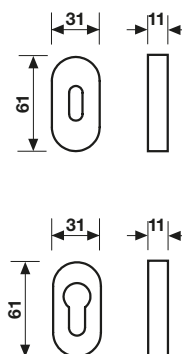

**K 3037**  
Foro chiave normale  
Standard hole  
escutcheon

**K 3037 Y**  
Foro chiave cilindro  
Euro-profile hole  
escutcheon

## K 382 50

**Materiale Ottone**  
Material Brass

**Finiture / Finishes**  
Cromosat  
Orolucido

**Chiusura privacy BZG**  
Bathroom privacy set

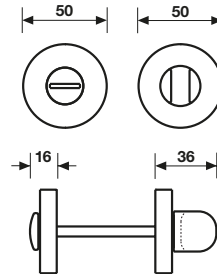

**K 382 R6-7-8 50 BZG - 85**



**K 382 RS6-7-8 50 BZG - 85**



## K 389 RG8

**Materiale Ottone**  
Material Brass

**Finiture / Finishes**  
Cromosat  
Orolucido

**Chiusura privacy BZG per RG8**  
Bathroom privacy set for RG8

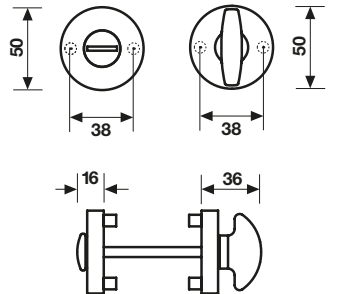

**K 389 RG6-7-8 50 BZG - 75**



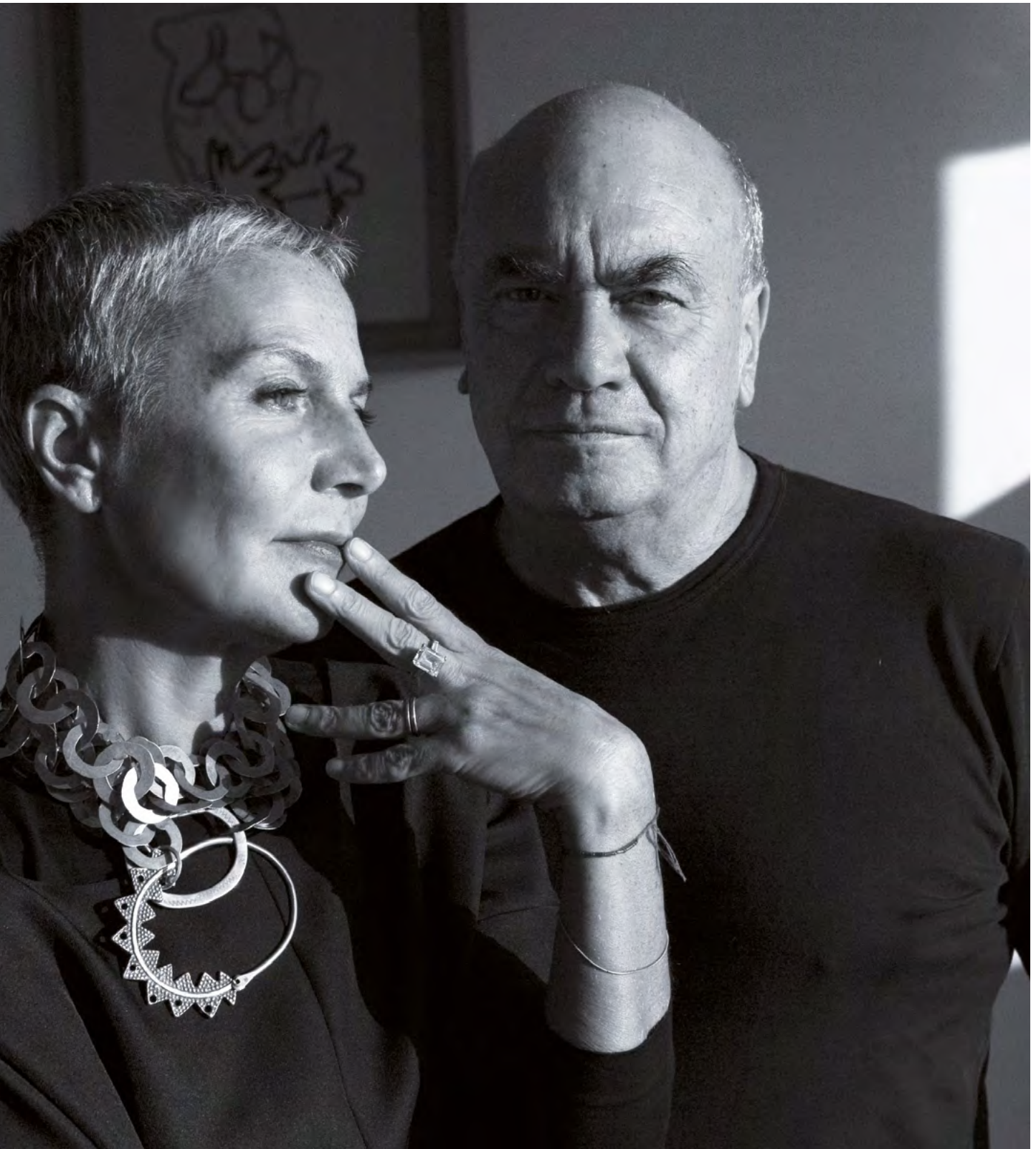

**Lo Studio Fuksas con sedi a Roma, Parigi, Shenzhen è guidato da Massimiliano Fuksas e Doriana O. Mandrelli. Di origini lituane, Massimiliano Fuksas è nato a Roma nel 1944 ed è tra i principali protagonisti della scena architettonica contemporanea sin dagli anni '80.**

**Doriana O. Mandrelli nasce a Roma dove consegue la laurea in Storia dell'Architettura Moderna e Contemporanea presso l'Università "La Sapienza" nel 1979. Dal 1985 collabora con Massimiliano Fuksas e dal 1997 è responsabile di "Fuksas Design".**

---

Studio Fuksas, with offices located in Rome, Paris and Shenzhen, is managed by Massimiliano Fuksas and Doriana O. Mandrelli. Having his origins from Lithuania, Massimiliano Fuksas was born in Rome in 1944 and he is one of the main protagonist of the contemporary architectural scene since 80s. Doriana O. Mandrelli was born in Rome where she obtained a degree in History of Modern and Contemporary Art at the University "La Sapienza" in 1979. Since 1985 collaborates with Massimiliano Fuksas and since 1997 has been responsible for "Fuksas Design".



Doriana O. Mandrelli

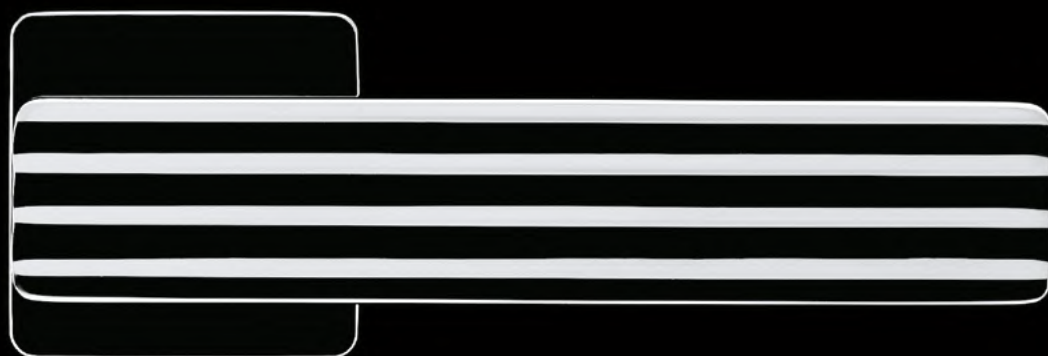

# H 370

Serie **MDF Duemiladieci**  
design Doriana e Massimiliano Fuksas

**Maniglia per porta**  
Door handle

**Materiale Ottone**  
Material Brass

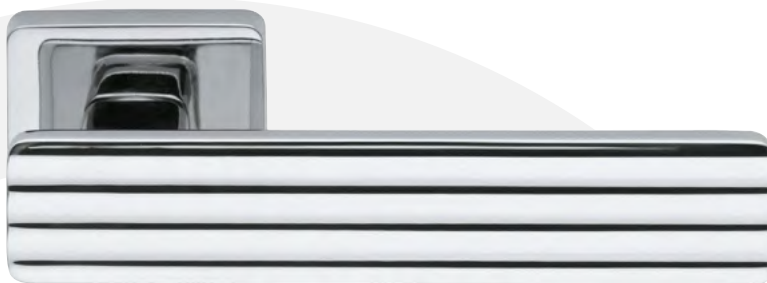
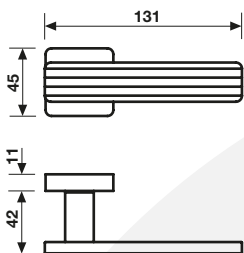

## Finiture

Finishes



Cromo



Cromosat



Disponibile anche CLASSE 4 su R8 / RG8  
secondo la norma DIN EN 1906 - Digit 4 7 - 01 - 0 B  
Available also CLASS 4 on R8 / RG8  
according to the DIN Standard EN 1906 - Digit 4 7 - 01 - 0 B

## H 370 FRS-41

**Maniglia per finestra**  
Window handle

**Movimento**  
4 scatti  
Movement  
4 click positions

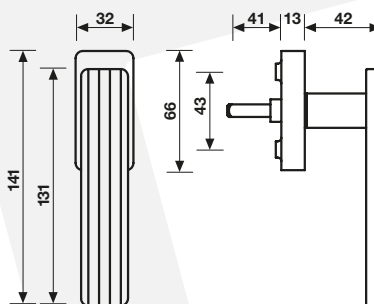

### H 370 R7 / R8

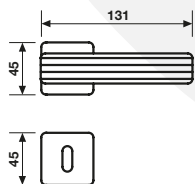

### H 370 R7 Y / R8 Y

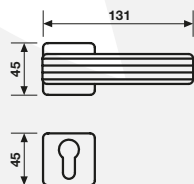

### H 370 RG8 / 8.5

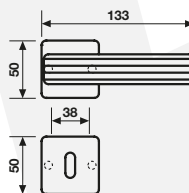

### H 370 RG8 / 8.5 Y

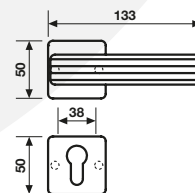

### H 370 RG6-7-8 BZG

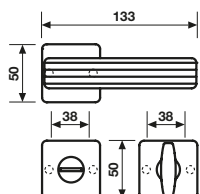

### H 370 RP Passage

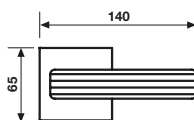

### H 370 RP Privacy

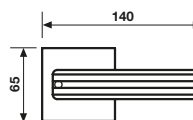

### H 370 RSB

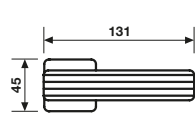



## K 3032

**Bocchetta**  
Escutcheon



**Materiale Nikrall Lega Zama UNI 3717**  
Material Nikrall Lega Zama UNI 3717

**Finiture / Finishes**  
Cromo  
Cromosat

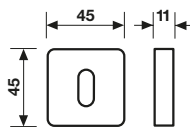

**K 3032**  
Foro chiave normale  
Standard hole  
escutcheon

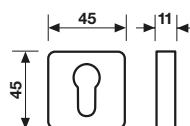

**K 3032 Y**  
Foro chiave cilindro  
Euro-profile hole  
escutcheon

## K 3034 CP

**Bocchetta per RG8**  
Escutcheon for RG8



**Materiale Nikrall Lega Zama UNI 3717**  
Material Nikrall Lega Zama UNI 3717

**Finiture / Finishes**  
Cromo  
Cromosat

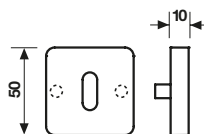

**K 3034 CP**  
Foro chiave normale  
Standard hole  
escutcheon

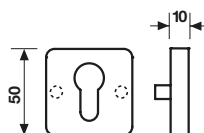

**K 3034 CP Y**  
Foro chiave cilindro  
Euro-profile hole  
escutcheon

## K 3038

**Bocchetta stretta**  
Narrow Escutcheon

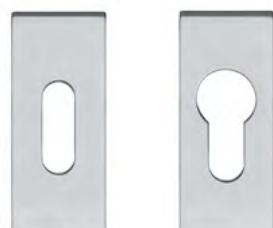

**Materiale Ottone**  
Material Brass

**Finiture / Finishes**  
Cromo  
Cromosat

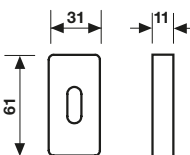

**K 3038**  
Foro chiave normale  
Standard hole  
escutcheon

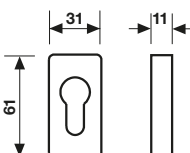

**K 3038 Y**  
Foro chiave cilindro  
Euro-profile hole  
escutcheon

## K 3029

**Materiale Nikrall Lega Zama UNI 3717**  
Material Nikrall Lega Zama UNI 3717

**Finiture / Finishes**  
Cromo  
Cromosat

**Chiusura privacy BZG**  
Bathroom privacy set

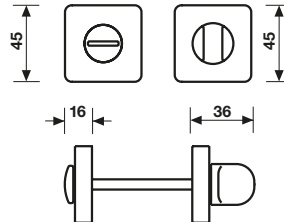

**K 3029 R6-7-8 BZG - 85**



**K 3029 RS6-7-8 BZG - 85**



## K 3029 RG8

**Materiale Nikrall Lega Zama UNI 3717**  
Material Nikrall Lega Zama UNI 3717

**Finiture / Finishes**  
Cromo  
Cromosat

**Chiusura privacy BZG per RG8**  
Bathroom privacy set for RG8

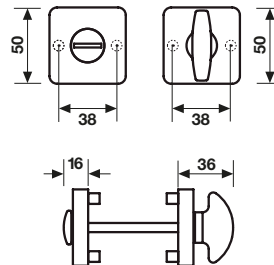

**K 3029 RG6-7-8 BZG - 75**



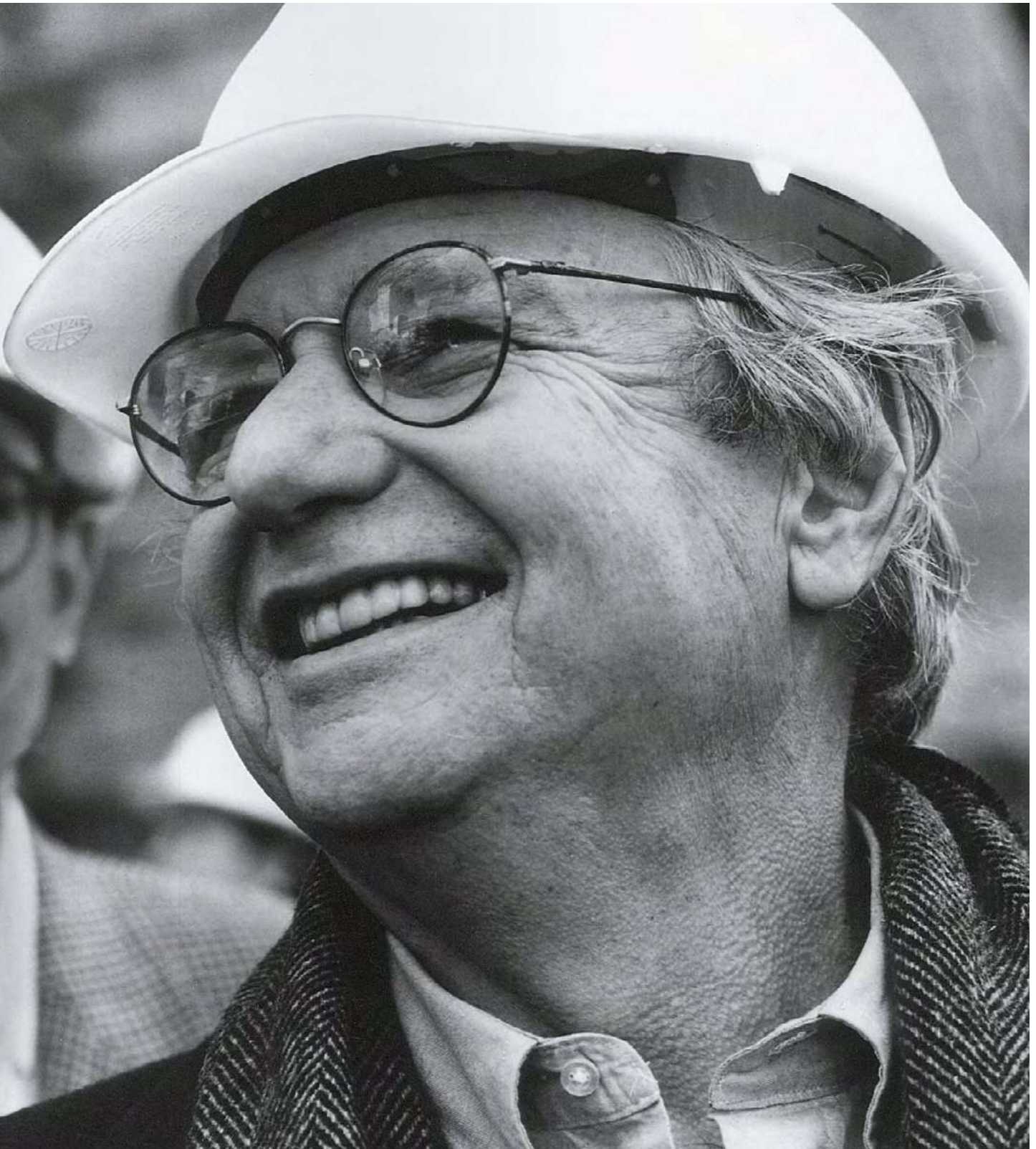

**Cresciuto a Toronto, Canada, Frank Gehry si trasferì con la sua famiglia a Los Angeles nel 1947. Gehry si è laureato in Architettura presso la University of Southern California nel 1954, ha studiato Urbanistica presso l'Università di Harvard di Design. Negli anni successivi, Gehry ha costruito una carriera di architetto che dura da ben cinque decenni e ha prodotto edifici pubblici e privati in America, Europa e Asia. Con il suo lavoro, Gehry, si è guadagnato alcuni dei premi più significativi in campo architettonico, tra cui il Premio Pritzker.**

---

Raised in Toronto, Canada, Frank Gehry moved with his family to Los Angeles in 1947. Mr. Gehry received his Bachelor of Architecture degree from the University of Southern California in 1954, and he studied City Planning at the Harvard University Graduate School of Design. In subsequent years, Mr. Gehry has built an architectural career that has spanned five decades, designing public and private buildings in America, Europe and Asia. Through his activity, Mr. Gehry has earned several of the most significant awards in the architectural field, including the Pritzker Prize.

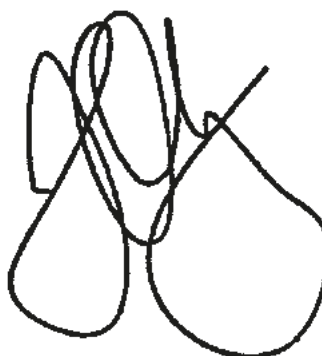



# H 354

Serie **FOG Duemilaquattro**  
design Frank O. Gehry

**Maniglia per porta**  
Door handle

**Materiale Ottone**  
Material Brass

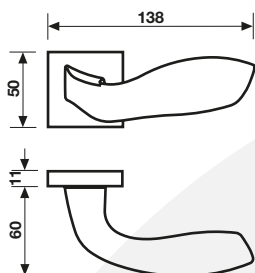

## Finiture

Finishes

-  Cromo
-  Cromosat
-  Orolucido

## H 354 FRS-41

**Maniglia per finestra**  
Window handle

**Movimento**  
**4 scatti**  
Movement  
4 click positions

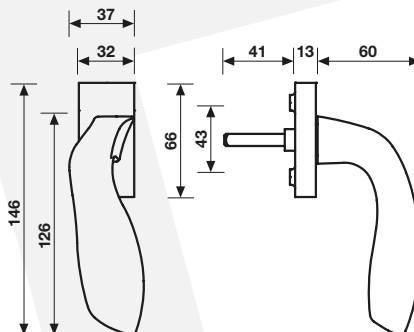

Disponibile anche CLASSE 4 su R8 / RG8  
secondo la norma DIN EN 1906 - Digit 4 7 - 01 - 0 B  
Available also CLASS 4 on R8 / RG8  
according to the DIN Standard EN 1906 - Digit 4 7 - 01 - 0 B

### H 354 R7 / R8

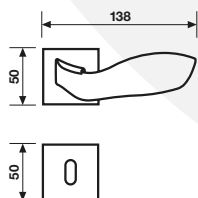

### H 354 R7 Y / R8 Y

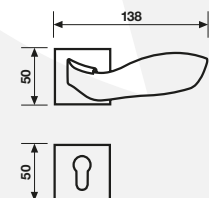

### H 354 RG8 / 8.5

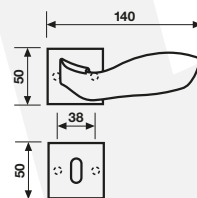

### H 354 RG8 / 8.5 Y

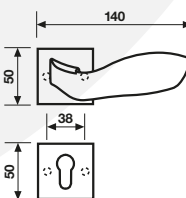

### H 354 RG6-7-8 BZG

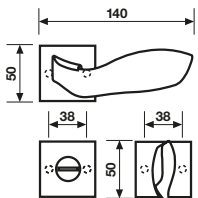

### H 354 RP Passage

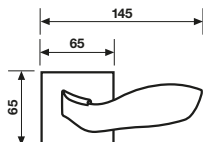

### H 354 RP Privacy

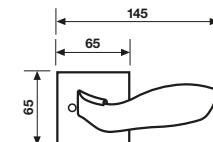

### H 354 RSB

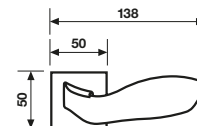

## K 3033

**Bocchetta**  
Escutcheon



**Materiale Nikrall Lega Zama UNI 3717**  
Material Nikrall Lega Zama UNI 3717

**Finiture / Finishes**  
Cromo  
Cromosat  
Orolucido

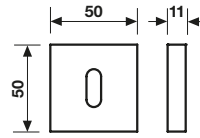

**K 3033**  
Foro chiave normale  
Standard hole  
escutcheon

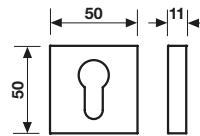

**K 3033 Y**  
Foro chiave cilindro  
Euro-profile hole  
escutcheon

## K 3033 CP

**Bocchetta per RG8**  
Escutcheon for RG8



**Materiale Nikrall Lega Zama UNI 3717**  
Material Nikrall Lega Zama UNI 3717

**Finiture / Finishes**  
Cromo  
Cromosat  
Orolucido

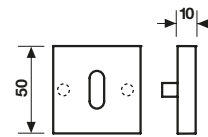

**K 3033 CP**  
Foro chiave normale  
Standard hole  
escutcheon

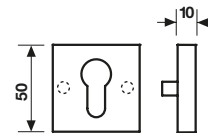

**K 3033 CP Y**  
Foro chiave cilindro  
Euro-profile hole  
escutcheon

## K 3038

**Bocchetta stretta**  
Narrow Escutcheon

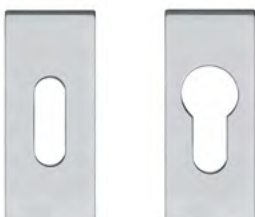

**Materiale Ottone**  
Material Brass

**Finiture / Finishes**  
Cromo  
Cromosat  
Orolucido

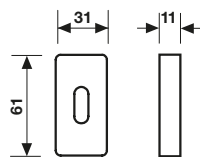

**K 3038**  
Foro chiave normale  
Standard hole  
escutcheon

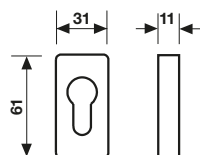

**K 3038 Y**  
Foro chiave cilindro  
Euro-profile hole  
escutcheon

## K 3020

**Materiale Nikrall Lega Zama UNI 3717**  
Material Nikrall Lega Zama UNI 3717

**Finiture / Finishes**  
Cromo  
Cromosat  
Orolucido

**Chiusura privacy BZG**  
Bathroom privacy set

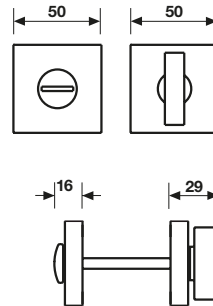

**K 3020 R6-7-8 BZG - 85**



## K 3020 RG8

**Materiale Nikrall Lega Zama UNI 3717**  
Material Nikrall Lega Zama UNI 3717

**Finiture / Finishes**  
Cromo  
Cromosat  
Orolucido

**Chiusura privacy BZG per RG8**  
Bathroom privacy set for RG8

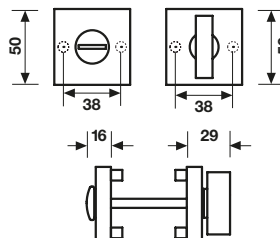

**K 3020 RG6-7-8 50 BZG - 85**







**L'Architetto Goshen è uno degli architetti più importanti di Israele, responsabile di numerosi grandi progetti, coprendo quasi ogni aspetto della pianificazione e progettazione. Tra i più noti edifici, la stazione ferroviaria Hashalon a Tel Aviv. L'Architetto Goshen scrive regolarmente su architettura e design, e siede in diversi comitati professionali e pubblici. Da quando è tornato all'insegnamento, è docente presso la Shenkar School of Design and Engineering. Dopo l'acquisto di una proprietà del 13° secolo nei pressi di Lucca, Toscana, sta attualmente lavorando con alcune aziende italiane sviluppando prodotti da lui disegnati.**

---

Architect Goshen is one of Israel's leading architects, responsible for numerous major projects, covering almost every aspect of planning and design. Among the better-known buildings is the Hashalon railway station in Tel Aviv. Architect Goshen writes regularly on architecture and design, and sits at various professional and public committees. Since returning to teaching, he is a professor at Shenkar School of Design and Engineering. After buying a 13th century estate near Lucca, Tuscany, he is currently working with a few Italian companies developing products designed by him.



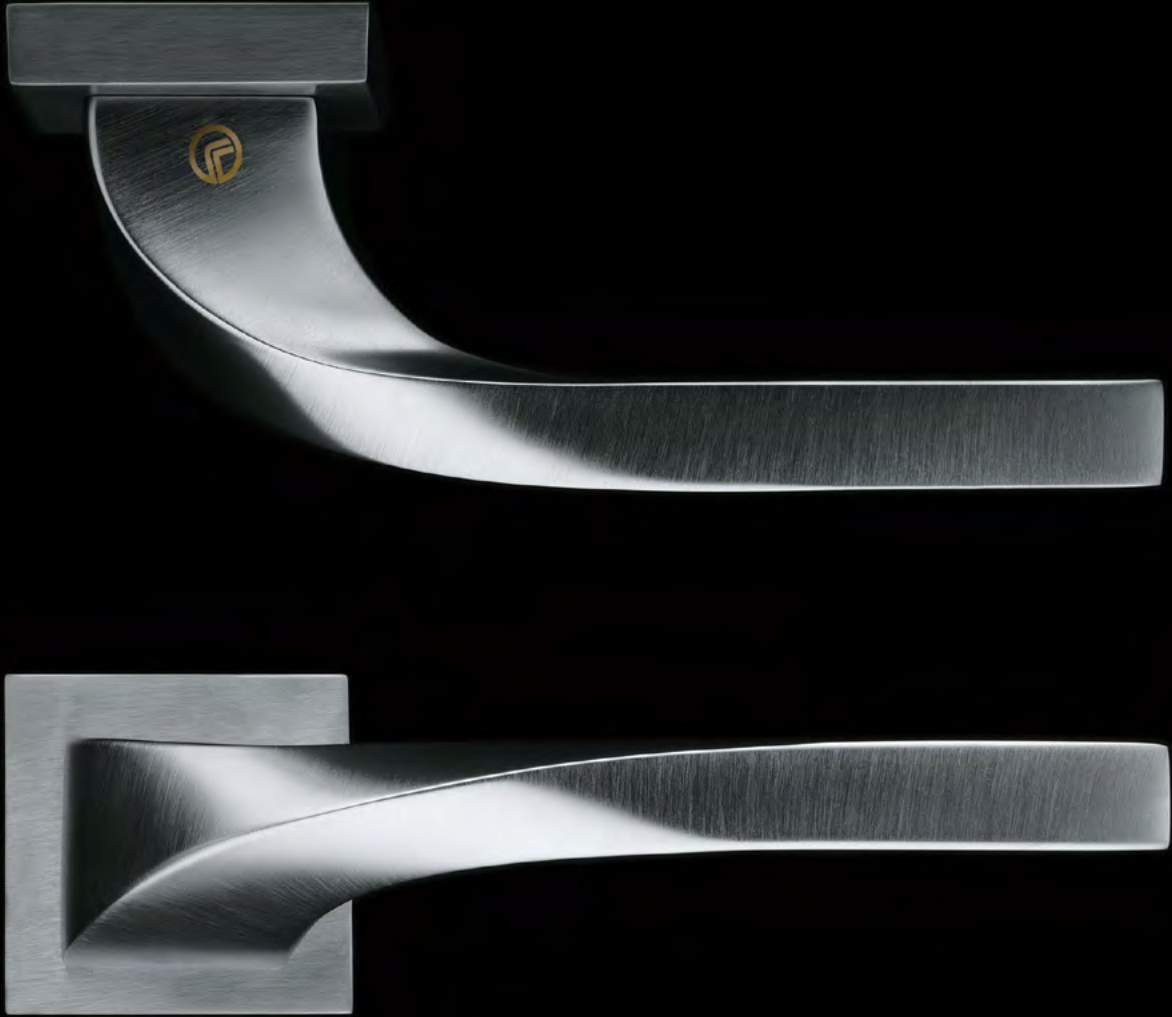

# H 372

Serie **EG Duemilaudici**  
design Eri Goshen

**Maniglia per porta**  
Door handle

**Materiale Ottone**  
Material Brass

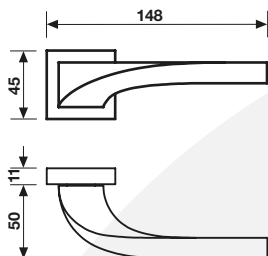

## Finiture

Finishes



Cromo



Cromosat



Disponibile anche CLASSE 4 su R8 / RG8  
secondo la norma DIN EN 1906 - Digit 4 7 - 01 - 0 B  
Available also CLASS 4 on R8 / RG8  
according to the DIN Standard EN 1906 - Digit 4 7 - 01 - 0 B

## H 372 FRS-41

**Maniglia per finestra**  
Window handle

**Movimento**  
4 scatti  
Movement  
4 click positions

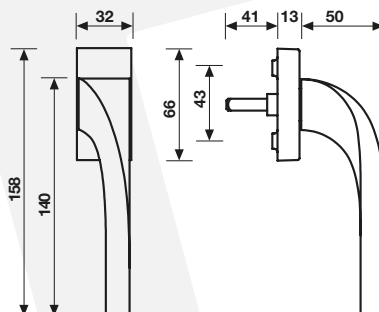

### H 372 R7 / R8

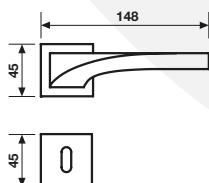

### H 372 R7 Y / R8 Y

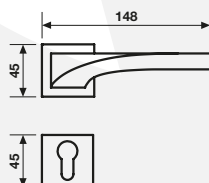

### H 372 RG8 / 8.5

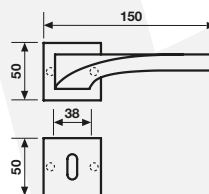

### H 372 RG8 / 8.5 Y

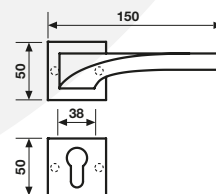

### H 372 RG6-7-8 BZG

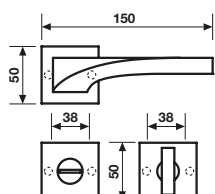

### H 372 RP Passage

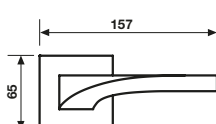

### H 372 RP Privacy

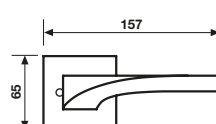

### H 372 RSB

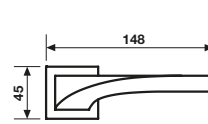

## K 3031

**Materiale Nikrall Lega Zama UNI 3717**  
Material Nikrall Lega Zama UNI 3717

**Finiture / Finishes**  
Cromo  
Cromosat

**Bocchetta**  
Escutcheon

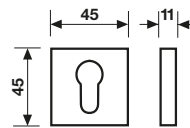
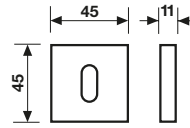

**K 3031**  
Foro chiave normale  
Standard hole  
escutcheon

**K 3031 Y**  
Foro chiave cilindro  
Euro-profile hole  
escutcheon

## K 3033 CP

**Materiale Nikrall Lega Zama UNI 3717**  
Material Nikrall Lega Zama UNI 3717

**Finiture / Finishes**  
Cromo  
Cromosat

**Bocchetta per RG8**  
Escutcheon for RG8

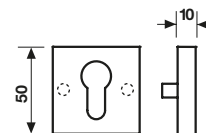
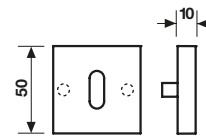

**K 3033 CP**  
Foro chiave normale  
Standard hole  
escutcheon

**K 3033 CP Y**  
Foro chiave cilindro  
Euro-profile hole  
escutcheon

## K 3038

**Materiale Ottone**  
Material Brass

**Finiture / Finishes**  
Cromo  
Cromosat

**Bocchetta stretta**  
Narrow Escutcheon

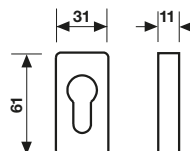
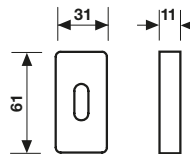
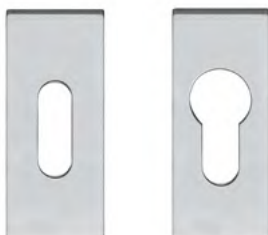

**K 3038**  
Foro chiave normale  
Standard hole  
escutcheon

**K 3038 Y**  
Foro chiave cilindro  
Euro-profile hole  
escutcheon

## K 3013

**Materiale Ottone**  
Material Brass

**Finiture / Finishes**  
Cromo  
Cromosat

**Chiusura privacy BZG**  
Bathroom privacy set

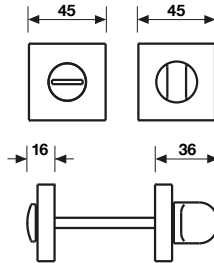

**K 3013 R6-7-8 BZG**



## K 3020 RG8

**Materiale Nikrall Lega Zama UNI 3717**  
Material Nikrall Lega Zama UNI 3717

**Finiture / Finishes**  
Cromo  
Cromosat

**Chiusura privacy BZG per RG8**  
Bathroom privacy set for RG8

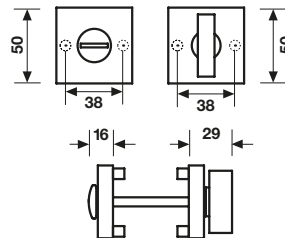

**K 3020 RG6-7-8 50 BZG - 85**



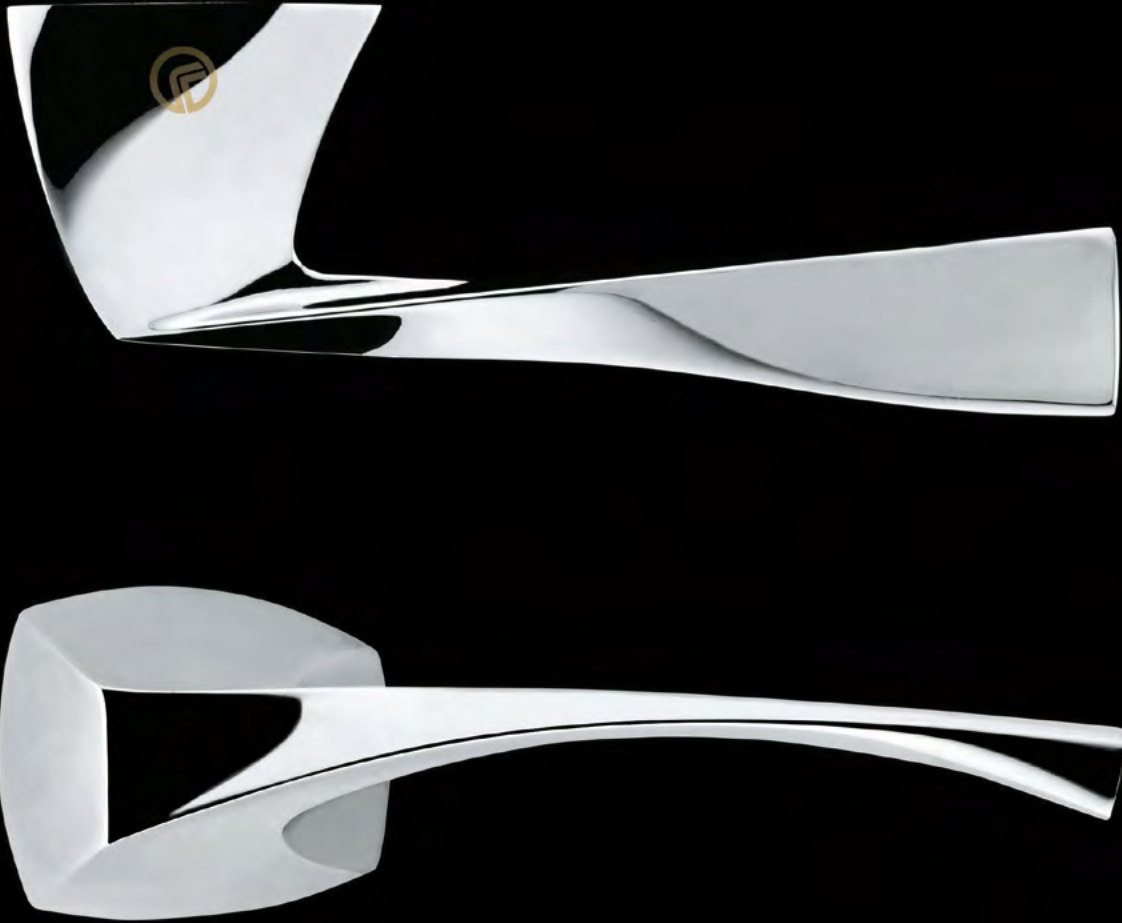

# H 369

Serie **EG Duemilanove**  
design Eri Goshen

**Maniglia per porta**  
Door handle

**Materiale Nikrall Lega Zama UNI 3717**  
Material Nikrall Lega Zama UNI 3717

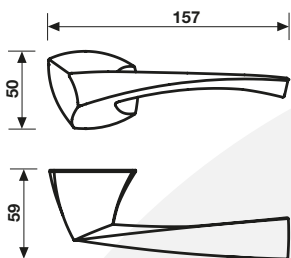

## Finiture

Finishes



Cromo



Cromosat

## H 369 FRS-41

**Maniglia per finestra**  
Window handle

**Movimento**  
**4 scatti**  
Movement  
4 click positions

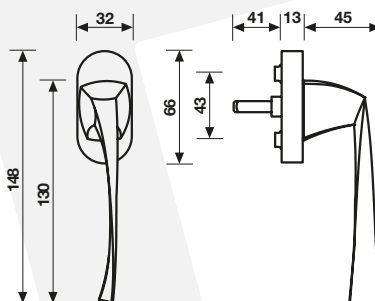

### H 369 R7 / R8

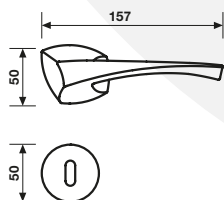

### H 369 R7 Y / R8 Y

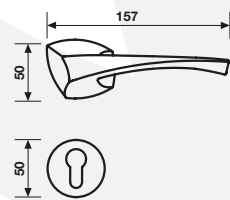

### H 369 RG8 / 8.5

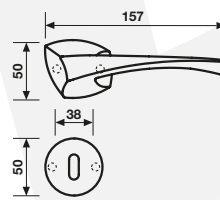

### H 369 RG8 / 8.5 Y

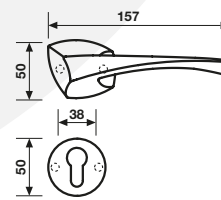

### H 369 RG6-7-8 BZG

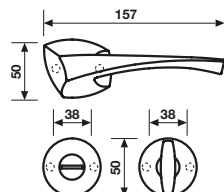

### H 369 RP Passage

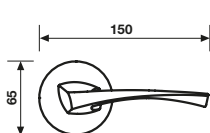

### H 369 RP Privacy

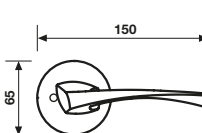

### H 369 RSB

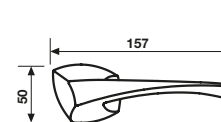



## K 383

**Materiale Ottone**  
Material Brass

**Finiture / Finishes**  
Cromo  
Cromosat

**Bocchetta**  
Escutcheon

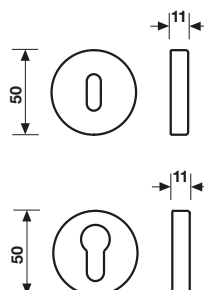

**K 383**  
Foro chiave normale  
Standard hole  
escutcheon

**K 383 Y**  
Foro chiave cilindro  
Euro-profile hole  
escutcheon

## K 3703 CP

**Materiale Ottone**  
Material Brass

**Finiture / Finishes**  
Cromo  
Cromosat

**Bocchetta per RG8**  
Escutcheon for RG8

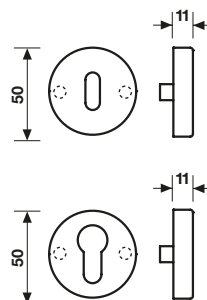

**K 3703 CP**  
Foro chiave normale  
Standard hole  
escutcheon

**K 3703 Y CP**  
Foro chiave cilindro  
Euro-profile hole  
escutcheon

## K 382 50

**Materiale Ottone**  
Material Brass

**Finiture / Finishes**  
Cromo  
Cromosat

**Chiusura privacy BZG**  
Bathroom privacy set

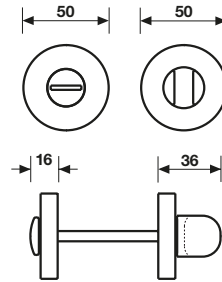

**K 382 R6-7-8 50 BZG - 85**



**K 382 RS6-7-8 50 BZG - 85**



## K 389 RG8

**Materiale Ottone**  
Material Brass

**Finiture / Finishes**  
Cromo  
Cromosat

**Chiusura privacy BZG per RG8**  
Bathroom privacy set for RG8

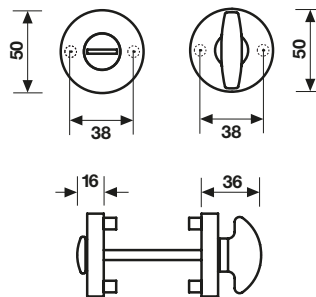

**K 389 RG6-7-8 50 BZG - 75**





**Zaha Hadid è nata a Baghdad, in Iraq nel 1950. Ha studiato matematica presso l'Università americana di Beirut prima di trasferirsi a Londra nel 1972 per partecipare alla Architectural Association (AA) School dove ha ottenuto il Diploma Prize nel 1977. Ha fondato Zaha Hadid Architects nel 1979 e da allora ha tenuto numerose sedie e cattedre come ospite presso le università di tutto il mondo. Woody Yao, da quando collabora con Zaha Hadid, nel 1994 ha gestito con successo una serie di progetti importanti. In qualità di membro anziano, continua a dirigere la sua squadra dalla competizione alla costruzione.**

---

Zaha Hadid, was born in Baghdad, Iraq in 1950. She studied mathematics at the American University of Beirut before moving to London in 1972 to attend the Architectural Association School where she was awarded the Diploma Prize in 1977. She founded Zaha Hadid Architects in 1979 and has since then she held numerous chairs and guest professorships at universities around the world. Woody Yao, since joining Zaha Hadid in 1994, continues to direct his team from competition to construction.

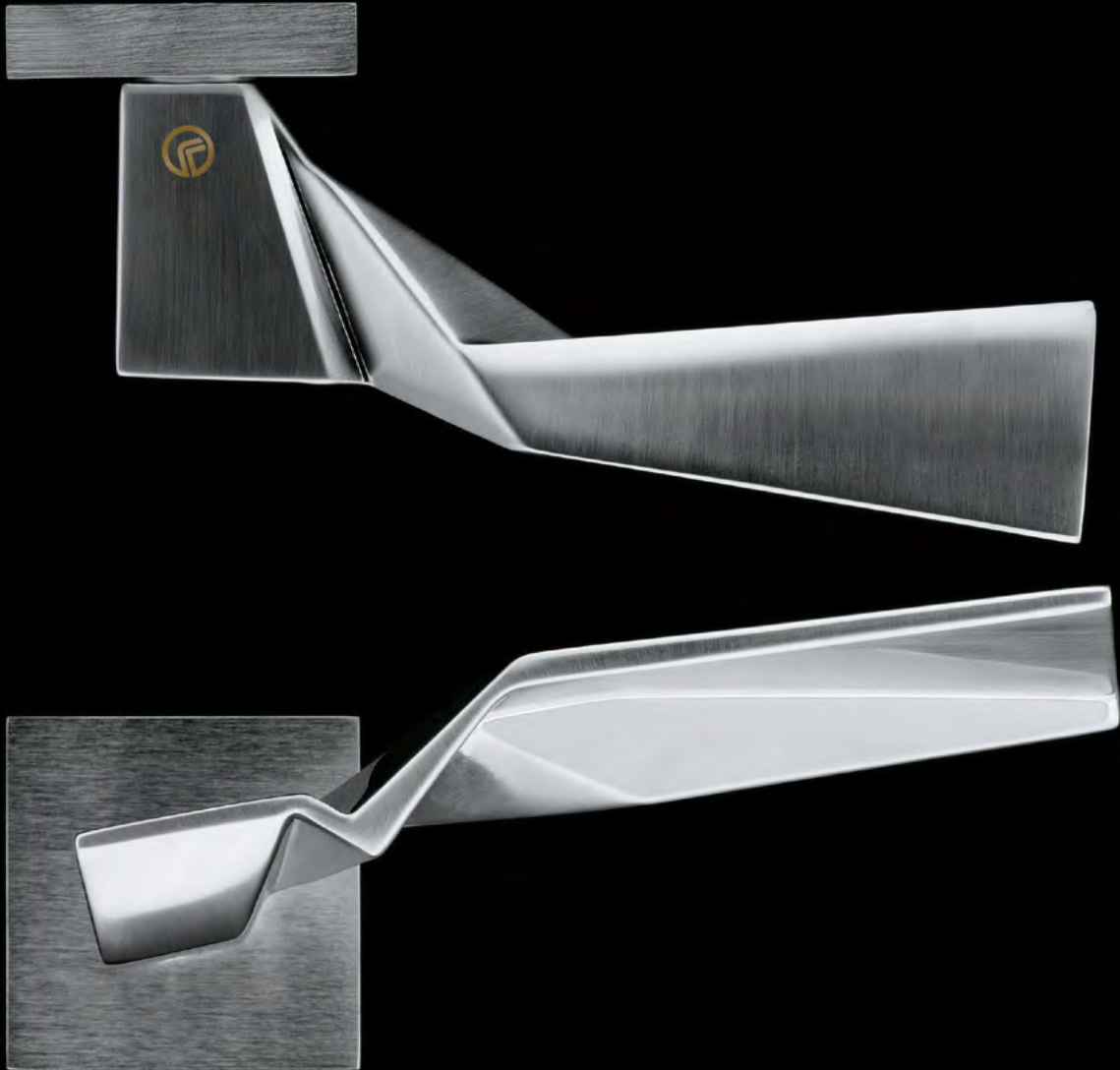

# H 356

Serie ZH Duemilacinque  
design Zaha Hadid

**Maniglia per porta**  
Door handle

**Materiale Nikrall Lega Zama UNI 3717**  
Material Nikrall Lega Zama UNI 3717

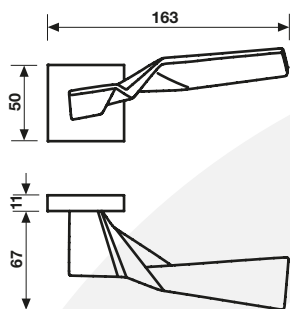

## Finiture

Finishes

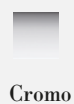

## H 356 FRS-41

**Maniglia per finestra**  
Window handle

**Movimento**  
4 scatti  
Movement  
4 click positions

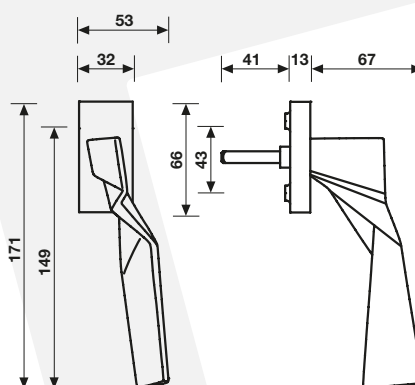

### H 356 R7 / R8

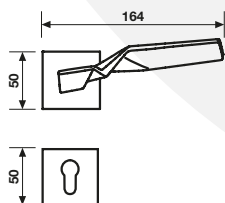

### H 356 R7 Y / R8 Y

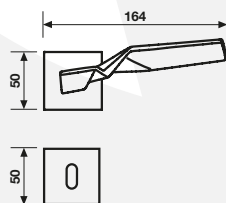

### H 356 RG8 / 8.5

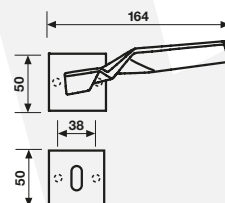

### H 356 RG8 / 8.5 Y

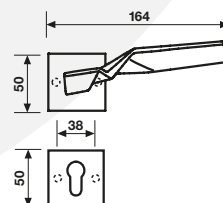

### H 356 RG6-7-8 BZG

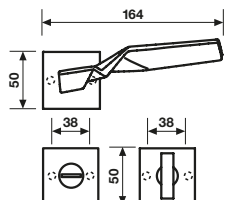

### H 356 RP Passage

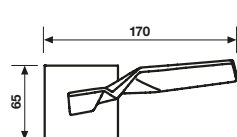

### H 356 RP Privacy

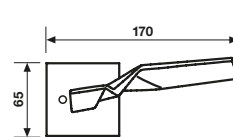

### H 356 RSB

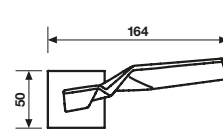

## K 3033

**Bocchetta**  
Escutcheon



**Materiale Nikrall Lega Zama UNI 3717**  
Material Nikrall Lega Zama UNI 3717

**Finiture / Finishes**  
Cromo  
Cromosat

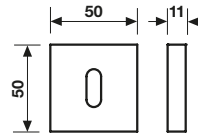

**K 3033**  
Foro chiave normale  
Standard hole  
escutcheon

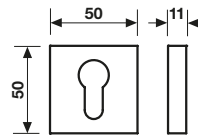

**K 3033 Y**  
Foro chiave cilindro  
Euro-profile hole  
escutcheon

## K 3033 CP

**Bocchetta per RG8**  
Escutcheon for RG8



**Materiale Nikrall Lega Zama UNI 3717**  
Material Nikrall Lega Zama UNI 3717

**Finiture / Finishes**  
Cromo  
Cromosat

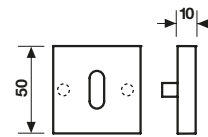

**K 3033 CP**  
Foro chiave normale  
Standard hole  
escutcheon

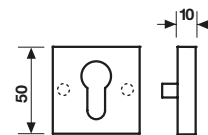

**K 3033 CP Y**  
Foro chiave cilindro  
Euro-profile hole  
escutcheon

## K 3038

**Bocchetta stretta**  
Narrow Escutcheon

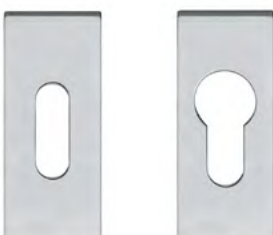

**Materiale Ottone**  
Material Brass

**Finiture / Finishes**  
Cromo  
Cromosat

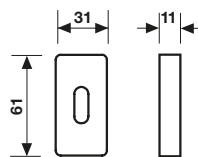

**K 3038**  
Foro chiave normale  
Standard hole  
escutcheon

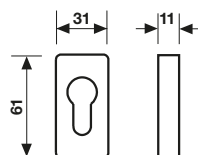

**K 3038 Y**  
Foro chiave cilindro  
Euro-profile hole  
escutcheon

## K 3020

**Materiale Nikrall Lega Zama UNI 3717**  
Material Nikrall Lega Zama UNI 3717

**Finiture / Finishes**  
Cromo  
Cromosat

**Chiusura privacy BZG**  
Bathroom privacy set

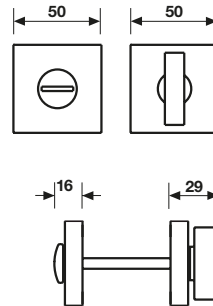

**K 3020 R6-7-8 50 BZG - 85**



## K 3020 RG8

**Materiale Nikrall Lega Zama UNI 3717**  
Material Nikrall Lega Zama UNI 3717

**Finiture / Finishes**  
Cromo  
Cromosat

**Chiusura privacy BZG per RG8**  
Bathroom privacy set for RG8

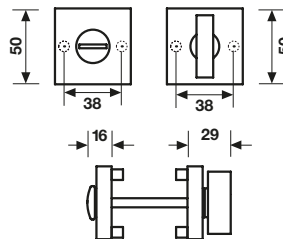

**K 3020 RG6-7-8 50 BZG - 85**





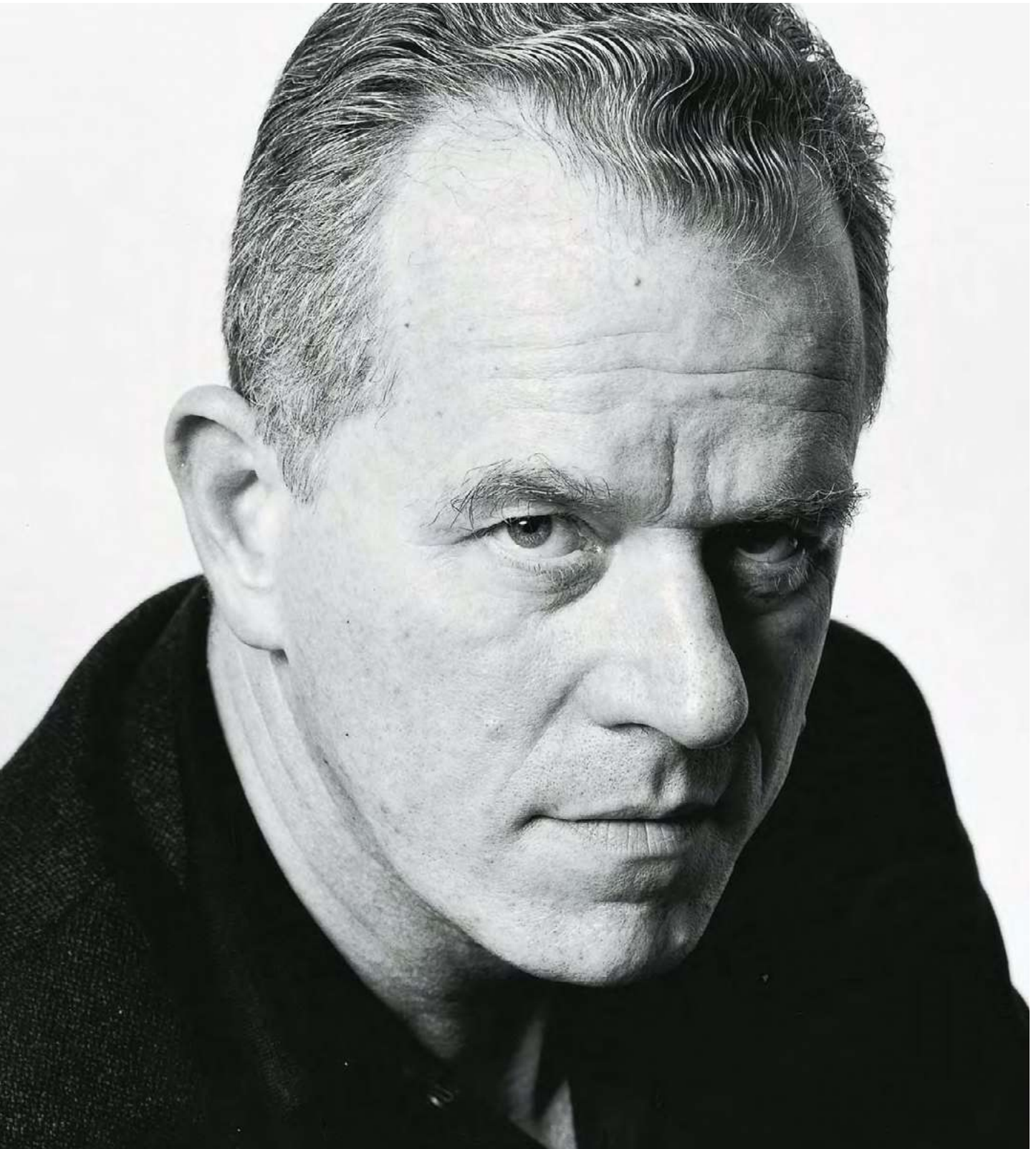

**Hans Kollhoff, nato il 18 settembre 1946 a Lobenstein/Thüringen, ha studiato dal 1968 sino al 1973 alla facoltà di Architettura dell' Università di Karlsruhe ed ha frequentato un corso all'estero nel 1974 presso la Technische Universität di Vienna. Dal 1984 Hans Kollhoff ha il suo ufficio di Berlino in società con l'Arch. Helga Timmermann. Con circa 50 collaboratori segue oggi un vasto programma di progetti nell'edilizia, prevalentemente costruzioni commerciali e uffici nonché complessi residenziali sia a Berlino che nel resto della Repubblica Federale Tedesca ed anche negli altri paesi europei. I lavori di Hans Kollhoff sono largamente pubblicati dalla stampa internazionale.**

---

Hans Kollhoff, born on 18th September 1946 in Lobenstein/Thüringen, studied at the Architecture Faculty of Karlsruhe University from 1968 to 1973, and followed a course at the "Technische Universität" of Vienna in 1974. Since 1984 Hans Kollhoff has had his office in Berlin, in partnership with the architect Helga Timmermann. Together with over 50 collaborators he today works on a wide ranging program of building projects, mainly commercial and office buildings, but also residential developments both in Berlin and the rest of the German Federal Republic and other European countries. The work of Hans Kollhoff has been widely published in the international press.

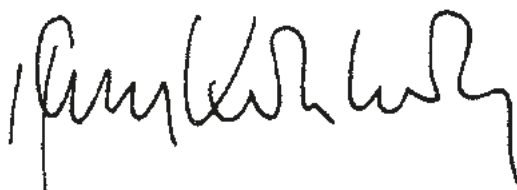



# H 341

Serie **HK2 Duemila**  
design Hans Kollhoff

**Maniglia per porta**  
Door handle

**Materiale Ottone e Acciaio Inox AISI 316 L\***  
Material Brass and Stainless Steel AISI 316 L\*

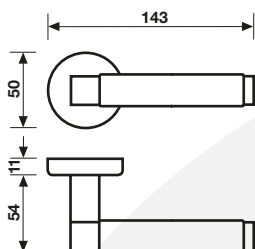

## Finiture

Finishes



Cromo/Inox satinato\*



## H 341 FRS-41

**Maniglia per finestra**  
Window handle

**Movimento**  
**4 scatti**  
Movement  
4 click positions

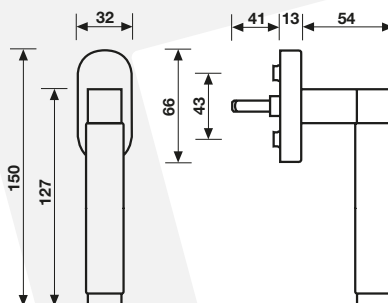

### H 341 R7 / R8

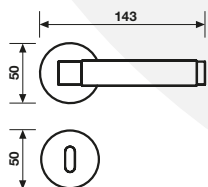

### H 341 R7 Y / R8 Y

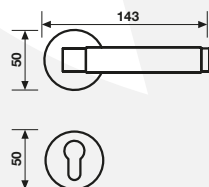

### H 341 RG8 / 8.5

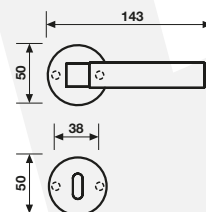

### H 341 RG8 / 8.5 Y

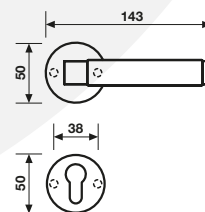

### H 341 RG6-7-8 BZG

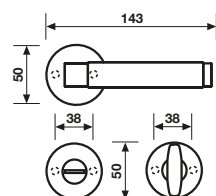

### H 341 RP Passage

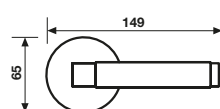

### H 341 RP Privacy

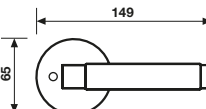

### H 341 RSB

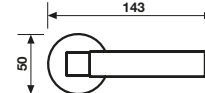

## K 383

**Materiale Ottone**  
Material Brass

**Finiture / Finishes**  
Cromo

**Bocchetta**  
Escutcheon

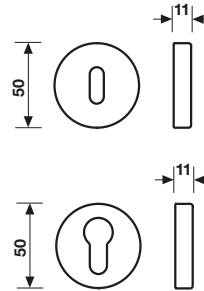

**K 383**  
Foro chiave normale  
Standard hole  
escutcheon

**K 383 Y**  
Foro chiave cilindro  
Euro-profile hole  
escutcheon

## K 3703 CP

**Materiale Ottone**  
Material Brass

**Finiture / Finishes**  
Cromo

**Bocchetta per RG8**  
Escutcheon for RG8

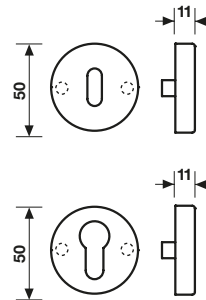

**K 3703 CP**  
Foro chiave normale  
Standard hole  
escutcheon

**K 3703 Y CP**  
Foro chiave cilindro  
Euro-profile hole  
escutcheon

## K 3037

**Materiale Ottone**  
Material Brass

**Finiture / Finishes**  
Cromo

**Bocchetta stretta**  
Narrow Escutcheon

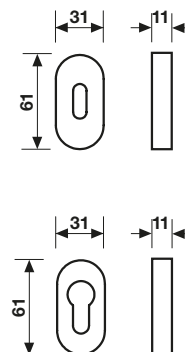

**K 3037**  
Foro chiave normale  
Standard hole  
escutcheon

**K 3037 Y**  
Foro chiave cilindro  
Euro-profile hole  
escutcheon

## K 382 50

**Materiale Ottone**  
Material Brass

**Finiture / Finishes**  
Cromo

**Chiusura privacy BZG**  
Bathroom privacy set

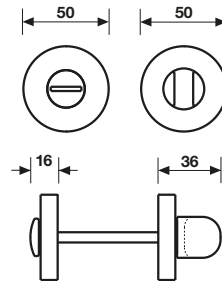

**K 382 R6-7-8 50 BZG - 85**



**K 382 RS6-7-8 50 BZG - 85**



## K 389 RG8

**Materiale Ottone**  
Material Brass

**Finiture / Finishes**  
Cromo

**Chiusura privacy BZG per RG8**  
Bathroom privacy set for RG8

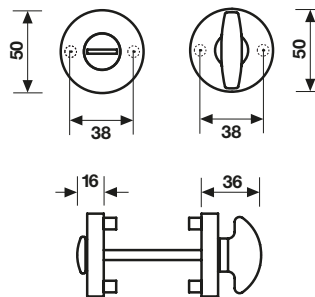

**K 389 RG6-7-8 50 BZG - 75**





**Yoshimi Kono è nato e cresciuto in Giappone. Suo nonno gestiva una società di costruzioni e suo padre lavorava per il Ministero delle Costruzioni in Giappone. Costantemente a contatto con i cantieri e le fabbriche di suo nonno, fu naturalmente influenzato nel diventare architetto nelle prime fasi della sua vita. Ha studiato architettura a Tokyo ed è stato un partner di Vignelli Associates per 14 anni prima di fondare la Kono Design nel 2000. Il suo approccio multi-disciplinare ai progetti comprende architettura, design d'interni, design di prodotti nonché grafica e identità aziendale.**

---

Yoshimi Kono was born and raised in Japan. His grandfather ran a construction company and his father worked for the Ministry of Construction in Japan. Constant exposure and visits to the construction sites and to his grandfather's factory, he was naturally influenced to be an architect in the early stages of his life. He studied architecture in Tokyo and became a partner at Vignelli Associates for 14 years before founding Kono Designs in 2000. His multi-disciplinary design practice includes architecture and interior design, product design and graphic design as well as corporate identity projects.







# H 338

Serie YK Duemila  
design Yoshimi Kono

**Maniglia per porta**  
Door handle

**Materiale Ottone**  
Material Brass

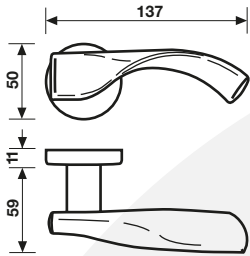

## Finiture

Finishes



Cromosat



Disponibile anche CLASSE 4 su R8 / RG8  
secondo la norma DIN EN 1906 - Digit 4 7 - 0 1 - 0 B  
Available also CLASS 4 on R8 / RG8  
according to the DIN Standard EN 1906 - Digit 4 7 - 0 1 - 0 B

## H 338 FRS-41

**Maniglia per finestra**  
Window handle

**Movimento**  
4 scatti  
Movement  
4 click positions

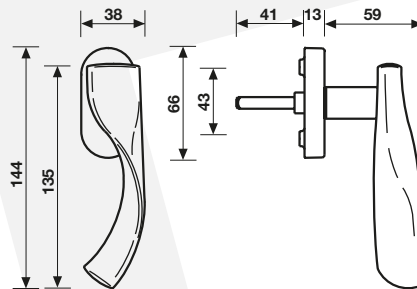

### H 338 R7 / R8

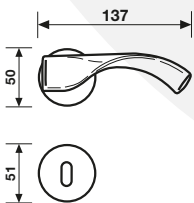

### H 338 R7 Y / R8 Y

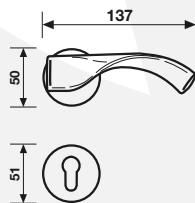

### H 338 RG8 / 8.5

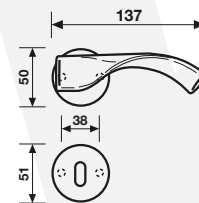

### H 338 RG8 / 8.5 Y

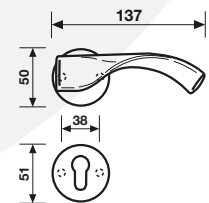

### H 338 RG6-7-8 BZG

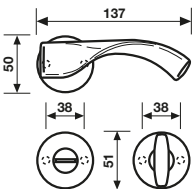

### H 338 RP Passage

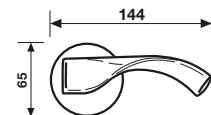

### H 338 RP Privacy

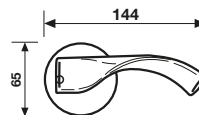

### H 338 RSB

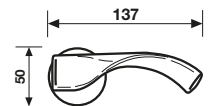

## K 383

**Materiale Ottone**  
Material Brass

**Finiture / Finishes**  
Cromosat

**Bocchetta**  
Escutcheon

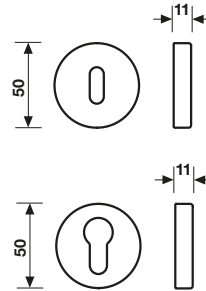

**K 383**  
Foro chiave normale  
Standard hole  
escutcheon

**K 383 Y**  
Foro chiave cilindro  
Euro-profile hole  
escutcheon

## K 3703 CP

**Materiale Ottone**  
Material Brass

**Finiture / Finishes**  
Cromosat

**Bocchetta per RG8**  
Escutcheon for RG8

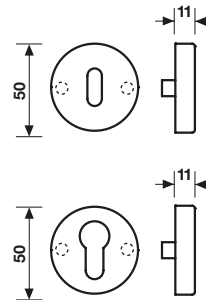

**K 3703 CP**  
Foro chiave normale  
Standard hole  
escutcheon

**K 3703 Y CP**  
Foro chiave cilindro  
Euro-profile hole  
escutcheon

## K 3037

**Materiale Ottone**  
Material Brass

**Finiture / Finishes**  
Cromosat

**Bocchetta stretta**  
Narrow Escutcheon

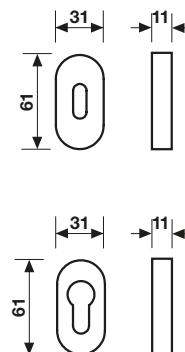

**K 3037**  
Foro chiave normale  
Standard hole  
escutcheon

**K 3037 Y**  
Foro chiave cilindro  
Euro-profile hole  
escutcheon

## K 382 50

**Materiale Ottone**  
Material Brass

**Finiture / Finishes**  
Cromosat

**Chiusura privacy BZG**  
Bathroom privacy set

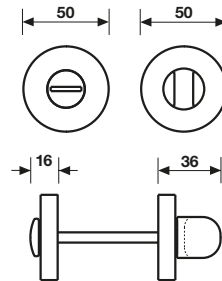

**K 382 R6-7-8 50 BZG - 85**



**K 382 RS6-7-8 50 BZG - 85**



## K 389 RG8

**Materiale Ottone**  
Material Brass

**Finiture / Finishes**  
Cromosat

**Chiusura privacy BZG per RG8**  
Bathroom privacy set for RG8

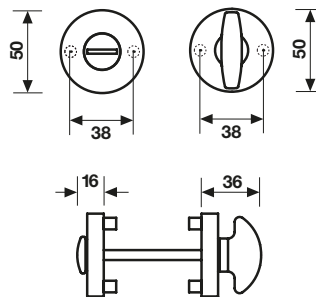

**K 389 RG6-7-8 50 BZG - 75**





**Steve Leung è uno dei più importanti architetti, interior e product designer di Hong Kong. Nel 1997 ha completamente riorganizzato e dato nuova linfa vitale allo studio Steve Leung Designers Ltd (SLD) dove dirige uno staff di oltre 400 geniali professionisti che lavorano su un'ampia gamma di progetti di design che vanno dallo sviluppo immobiliare e strutture residenziali, agli hotel e complessi commerciali in oltre 100 città nel mondo. Autentico paladino dello stile contemporaneo, Leung ha dato vita a opere accolte con favore in tutto il mondo. Nel 2013 è stato invitato a far parte del celebre studio di design londinese Yoo, mentre nel 2015 gli è stato conferito il prestigioso premio Andrew Martin International Interior Designer of the Year Award. Ha inoltre collaborato con diversi brand di fama internazionale come Neutra, Visionnaire e Villeroy & Boch.**

---

Steve Leung is a Hong Kong leading architect, interior and product designer. He restructured Steve Leung Designers Ltd (SLD) in 1997 and leads over 400 highly-calibrated staff to work on a wide spectrum of property development, residential, hospitality and commercial design projects spread over 100 cities globally. As a contemporary-style advocate, Steve's works were well received worldwide and was invited to join Yoo in 2013. He has won 2015 Andrew Martin International Interior Designer of the Year Award and collaborated with various international brands: Neutra, Visionnaire and Villeroy & Boch.





# H 377

Serie SL Duemilasedici  
design Steve Leung

**Maniglia per porta**  
Door handle

**Materiale Ottone**  
Material Brass

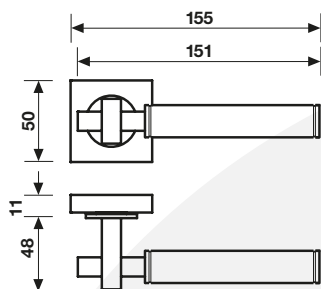

## Finiture

Finishes



Bronzo scuro



Titanium - PVD



Neropaco



Bronzo scuro / Pelle nera



## H 377 FRS-41

**Maniglia per finestra**  
Window handle

**Movimento**  
4 scatti  
Movement  
4 click positions

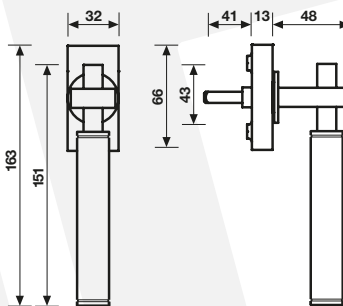

### H 377 R7 / R8

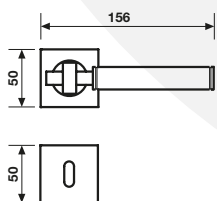

### H 377 R7 Y / R8 Y

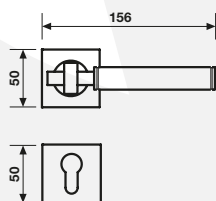

### H 377 RG8 / 8.5

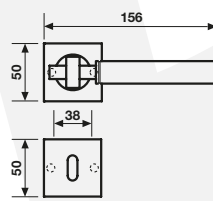

### H 377 RG8 / 8.5 Y

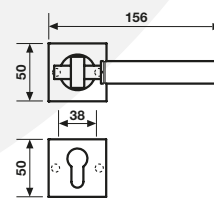

### H 377 RG6-7-8 BZG

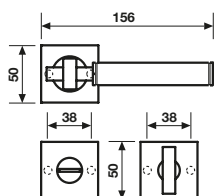

### H 377 RQ Passage

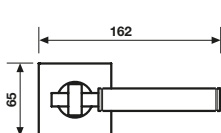

### H 377 RQ Privacy

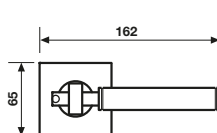

### H 377 RSB

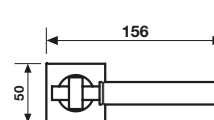



## **K 377**

**Maniglione**  
Pull Handle

**Materiale Ottone**  
Material Brass

**Finiture Finishes**  
Bronzo scuro  
Neropaco  
Titanium - PVD

**Interasse / Centre distance**  
300 mm

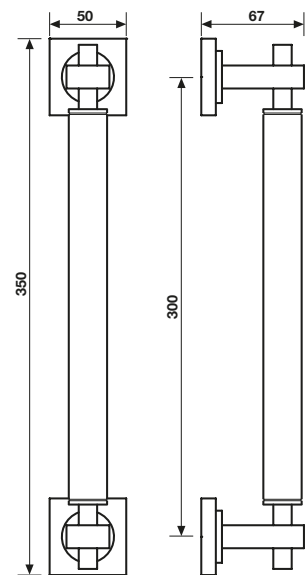

## K 377

**Pomolo per porta**  
Door knob

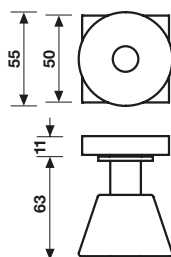

**Finiture / Finishes**  
Bronzo scuro  
Neropaco  
Titanium - PVD

**K 377 R8 / K 377 R8 Y**

**Materiale Ottone**  
Material Brass

## K 3033

**Bocchetta**  
Escutcheon

**Materiale Ottone**  
Material Brass

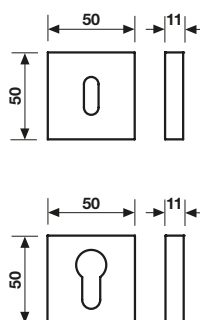

**Finiture / Finishes**  
Bronzo scuro  
Neropaco  
Titanium - PVD

**K 3033**  
Foro chiave normale  
Standard hole  
escutcheon

**K 3033 Y**  
Foro chiave cilindro  
Euro-profile hole  
escutcheon

## K 3020

**Chiusura privacy BZG**  
Bathroom privacy set

**Materiale Ottone**  
Material Brass

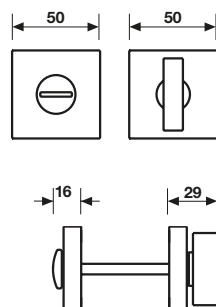

**Finiture / Finishes**  
Bronzo scuro  
Neropaco  
Titanium- PVD

**K 3020 R6-7-8 50 BZG - 85**



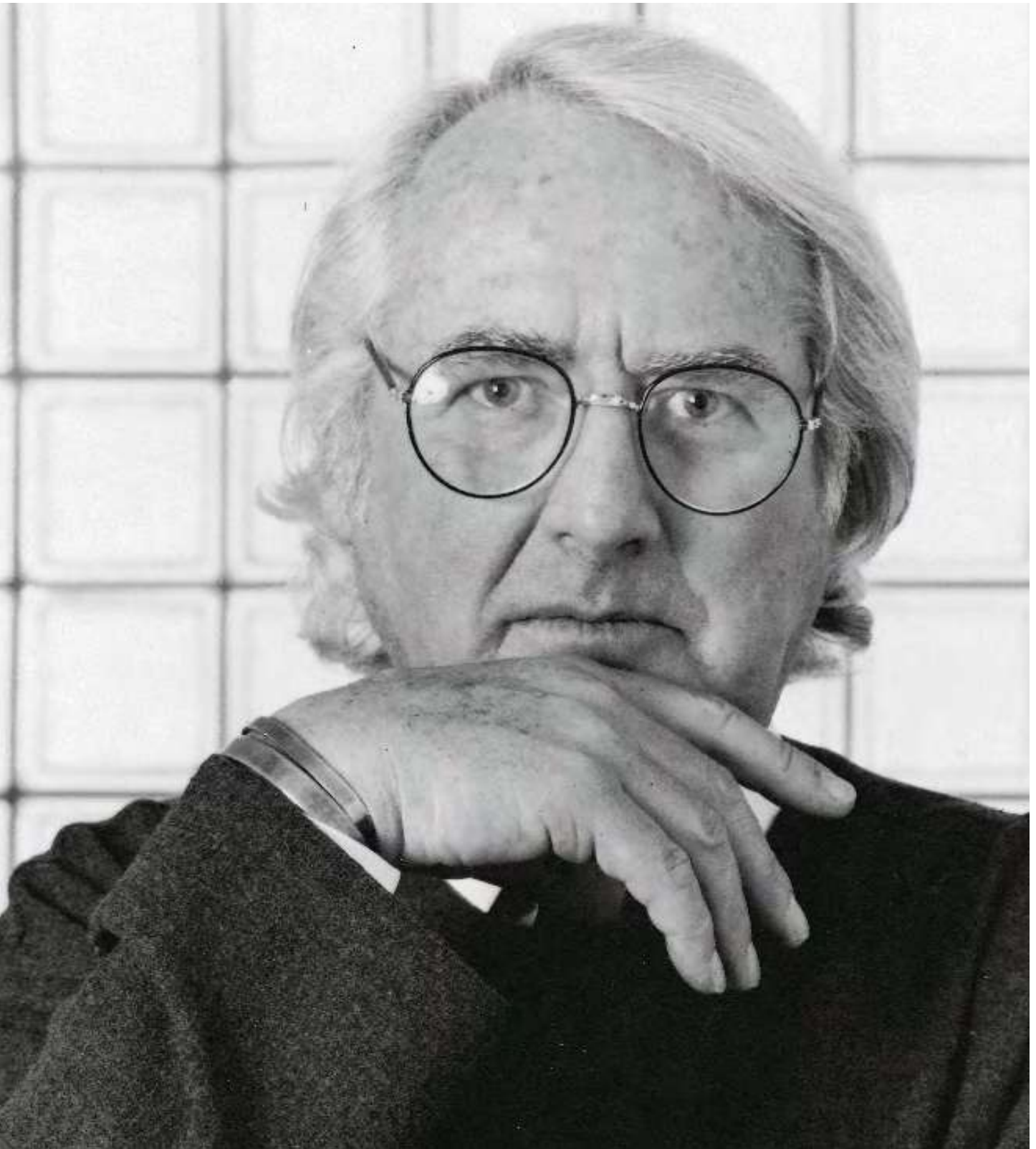

**Richard Meyer si è laureato in architettura alla Cornell University e fondato il suo ufficio a New York City nel 1963. Da quel momento il suo lavoro internazionale ha riguardato importanti commissioni culturali e civiche oltre a residenze private e strutture aziendali e accademiche. Ha ricevuto i più alti onori nel campo, compresi il Premio Pritzker per l'Architettura, le Medaglie d'oro dell'American Institute of Architects e il Royal Institute of British Architects nonché il Premium Imperiale dall'Art Japan Association. E' famoso in particolare per il Getty Center di Los Angeles, il Museo di Arte Contemporanea di Barcellona, e la Chiesa del Giubileo a Roma.**

---

Richard Meier received his architectural training at Cornell University and established his own office in New York City in 1963. Since then, his international practice has encompassed major cultural and civic projects as well as private residences, and corporate and academic facilities. He has received the highest honors in the field including the Pritzker Prize for Architecture, the Gold Medals of the American Institute of Architects and the Royal Institute of British Architects as well as the Premium Imperiale from the Japan Art Association.

He is best known for the Getty Center in Los Angeles; the Barcelona Museum of Contemporary Art, and the Jubilee Church in Rome.



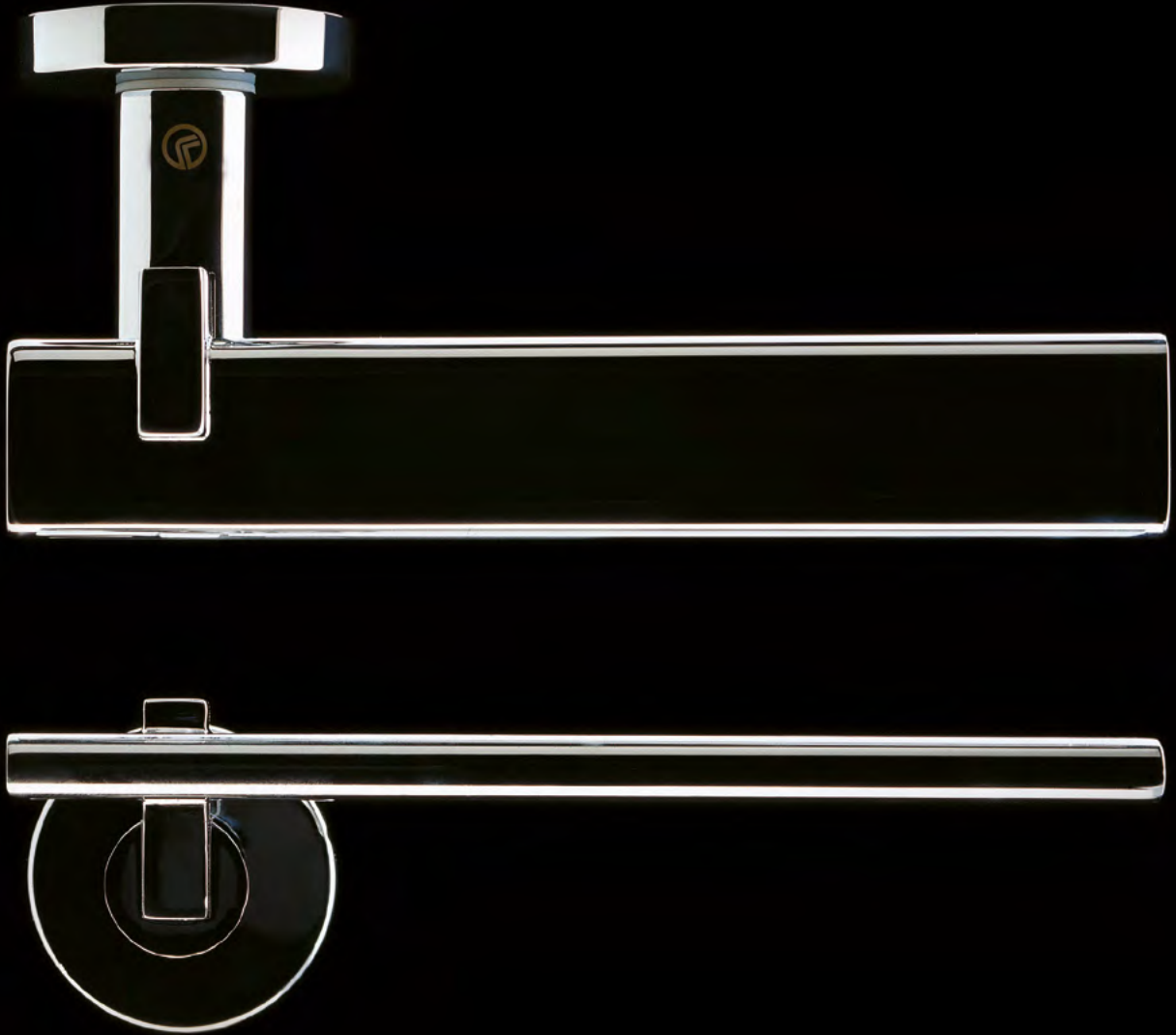

# H 335

Serie **RM Novantotto**  
design Richard Meier

**Maniglia per porta**  
Door handle

**Materiale Ottone**  
Material Brass

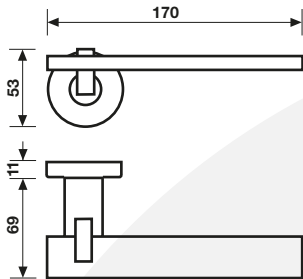

## Finiture

Finishes



Cromo

### H 335 R7 / R8

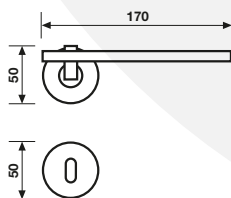

### H 335 R7 Y / R8 Y

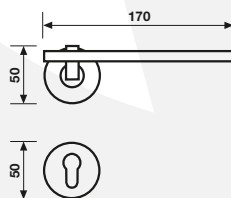

### H 335 RG8 / 8.5

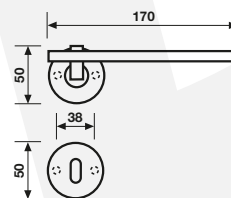

### H 335 RG8 / 8.5 Y

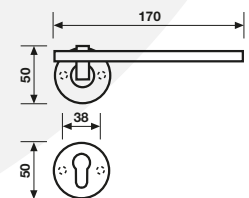

### H 335 RG6-7-8 BZC

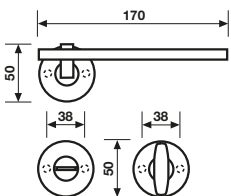

### H 335 RP Passage

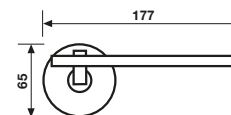

### H 335 RP Privacy

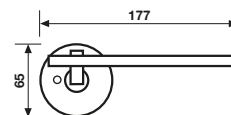

### H 335 RSB

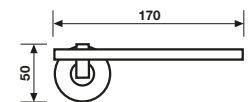

**Materiale Ottone**  
Material Brass

**Finiture Finishes**  
Cromo

## H 335 FRS-41

**Maniglia per finestra**  
Window handle

**Movimento**  
**4 scatti**  
Movement  
4 click positions

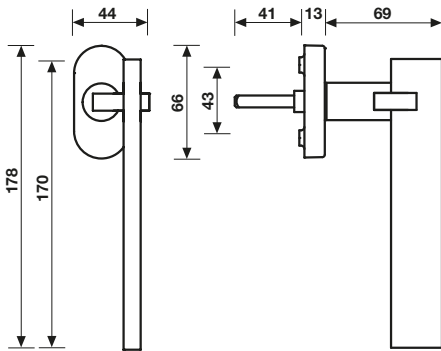

# K 352

Serie **RM Novantotto**  
design Richard Meier

## **Materiale Ottone**

Material Brass

## **Finiture Finishes**

Cromo

## **K 352 DX / SX**

### **Maniglione**

Pull Handle

### **Interasse / Centre distance**

210 mm

350 mm

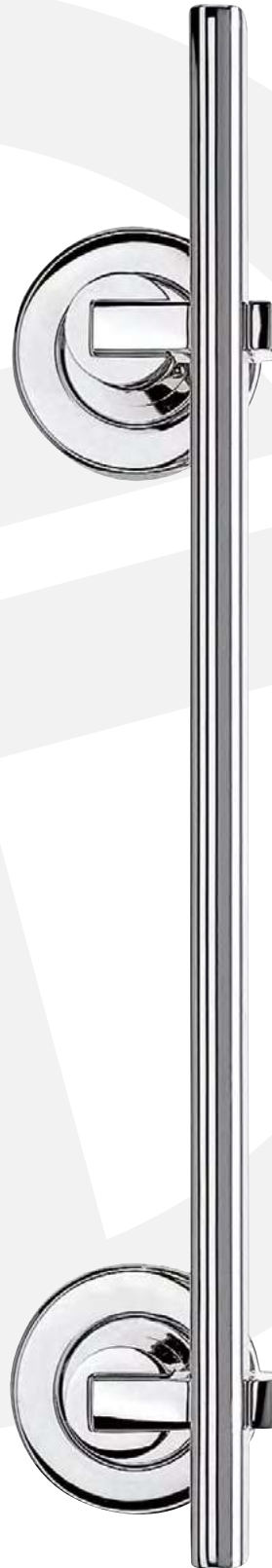
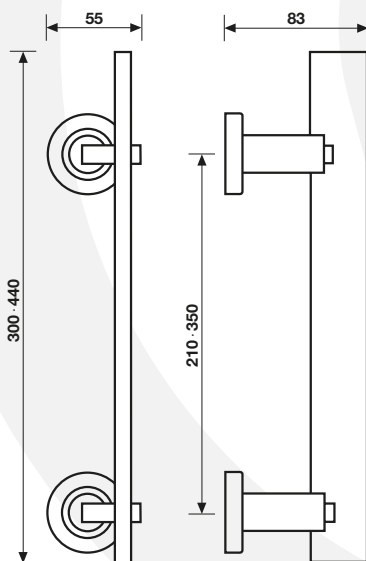



## K 383

**Materiale Ottone**  
Material Brass

**Finiture / Finishes**  
Cromo

**Bocchetta**  
Escutcheon

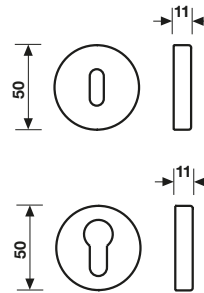

**K 383**  
Foro chiave normale  
Standard hole  
escutcheon

**K 383 Y**  
Foro chiave cilindro  
Euro-profile hole  
escutcheon

## K 3703 CP

**Materiale Ottone**  
Material Brass

**Finiture / Finishes**  
Cromo

**Bocchetta per RG8**  
Escutcheon for RG8

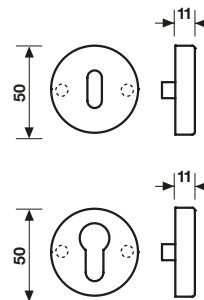

**K 3703 CP**  
Foro chiave normale  
Standard hole  
escutcheon

**K 3703 Y CP**  
Foro chiave cilindro  
Euro-profile hole  
escutcheon

## K 3037

**Materiale Ottone**  
Material Brass

**Finiture / Finishes**  
Cromo

**Bocchetta stretta**  
Narrow Escutcheon

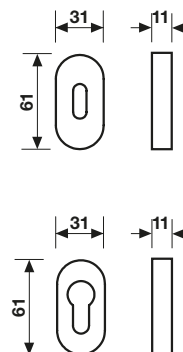

**K 3037**  
Foro chiave normale  
Standard hole  
escutcheon

**K 3037 Y**  
Foro chiave cilindro  
Euro-profile hole  
escutcheon

## K 382 50

**Materiale Ottone**  
Material Brass

**Finiture / Finishes**  
Cromo

**Chiusura privacy BZG**  
Bathroom privacy set

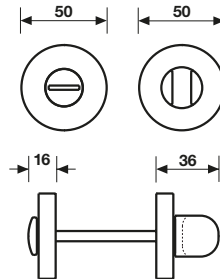

**K 382 R6-7-8 50 BZG - 85**



**K 382 RS6-7-8 50 BZG - 85**



## K 389 RG8

**Materiale Ottone**  
Material Brass

**Finiture / Finishes**  
Cromo

**Chiusura privacy BZG per RG8**  
Bathroom privacy set for RG8

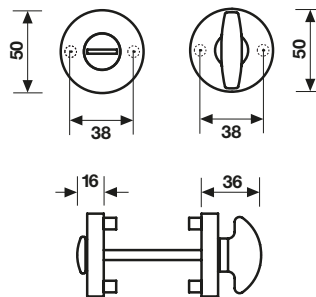

**K 389 RG6-7-8 50 BZG - 75**



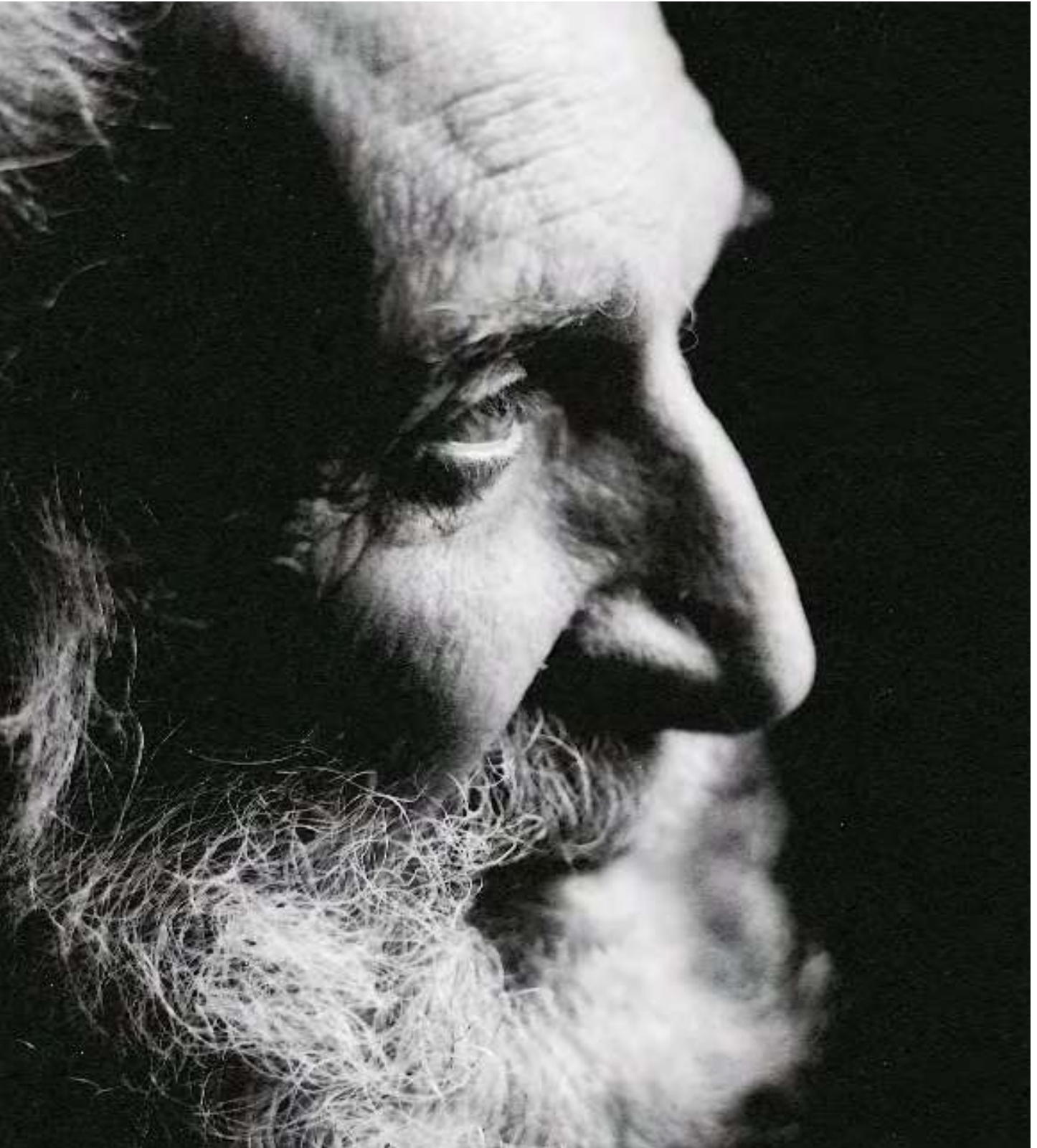

**Lorenzo (Renzo) Mongiardino (Genova, 12 maggio 1916 – Milano, 16 gennaio 1998) è stato un architetto e scenografo italiano. È stata una delle personalità più singolari della cultura italiana del secondo dopoguerra. Ha ricevuto due nomination al Premio Oscar nella categoria migliore scenografia. Noto sulla scena internazionale come abile creatore di spazi spettacolari, ha realizzato numerosi interni di grande fascino nelle più esclusive dimore di Roma, New York, Parigi, Milano, che hanno influenzato molti decoratori di tutto il mondo.**

---

Lorenzo (Renzo) Mongiardino (Genoa, 12 May 1916 – Milan, 16 January 1998) was an Italian architect, interior designer and production designer. He was nominated for two Academy Awards in the category Best Art Direction. Renowned on the international scene as a clever creator of spectacular spaces, Renzo Mongiardino has realised numerous very fascinating interiors in the most exclusive residences of Rome, New York, Paris and Milan, which have influenced many decorators all over the world.

*Renzo Mongiardino*



# H 332

Serie M Novantotto  
design Renzo Mongiardino

**Maniglia per porta**  
Door handle

**Materiale Ottone**  
Material Brass

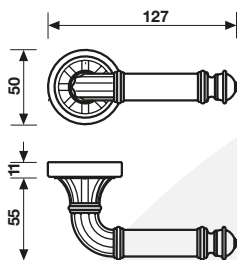

## Finiture

Finishes



Orolucido

## H 332 FRS-41

**Maniglia per finestra**  
Window handle

**Movimento**  
4 scatti  
Movement  
4 click positions

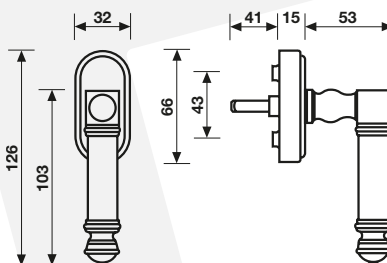

### H 332 R7 / R8

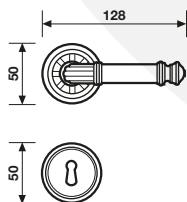

### H 332 R7 Y / R8 Y

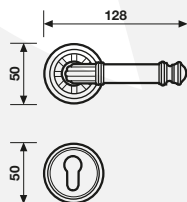

### H 332 RG8 / 8.5

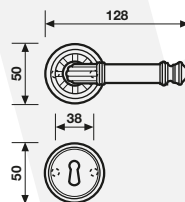

### H 332 RG8 / 8.5 Y

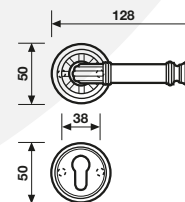

### H 332 RG6-7-8 BZG

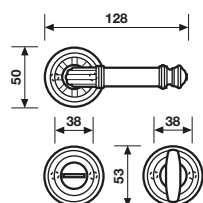

### H 332 RP Passage

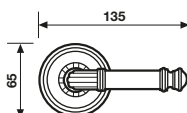

### H 332 RP Privacy

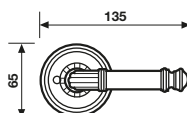

### H 332 RSB

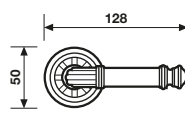

## K 3036

**Materiale Ottone**  
Material Brass

**Finiture / Finishes**  
Orolucido

**Bocchetta**  
Escutcheon

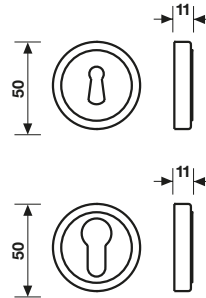

**K 3036**  
Foro chiave normale  
Standard hole  
escutcheon

**K 3036 Y**  
Foro chiave cilindro  
Euro-profile hole  
escutcheon

## K 3036 CP

**Materiale Ottone**  
Material Brass

**Finiture / Finishes**  
Orolucido

**Bocchetta per RG8**  
Escutcheon for RG8

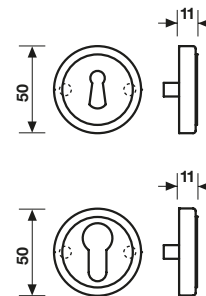

**K 3036 CP**  
Foro chiave normale  
Standard hole  
escutcheon

**K 3036 Y CP**  
Foro chiave cilindro  
Euro-profile hole  
escutcheon

## K 382 50

**Materiale Ottone**  
Material Brass

**Finiture / Finishes**  
Orolucido

**Chiusura privacy BZG**  
Bathroom privacy set

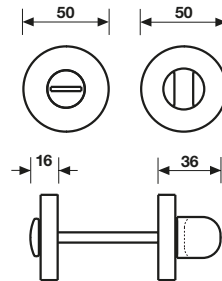

**K 382 R6-7-8 50 BZG - 85**



**K 382 RS6-7-8 50 BZG - 85**



## K 389 RG8

**Materiale Ottone**  
Material Brass

**Finiture / Finishes**  
Orolucido

**Chiusura privacy BZG per RG8**  
Bathroom privacy set for RG8

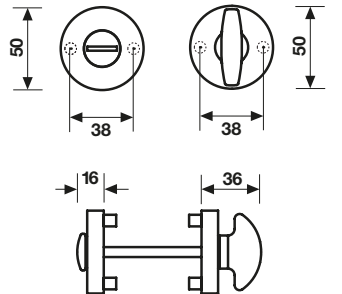

**K 389 RG6-7-8 50 BZG - 75**







**John Pawson ha trascorso più di 30 anni a fare architettura rigorosamente semplice, basata sulle qualità delle proporzioni, sulla luce e sui materiali. Gli esempi più importanti del suo lavoro includono il primo flagship store Calvin Klein a New York, il premiato Sackler Crossing in Kew Royal Botanic Gardens e il monastero cistercense di Nostra Signora di Novy Dvur in Boemia.**

**Attualmente sta rimodellando l'interno del carismatico ex Commonwealth Institute di Londra, ha in programma di aprire una nuova sede permanente per il Design Museum nel 2014.**

---

John Pawson has spent more than 30 years making rigorously simple architecture, based on the qualities of proportion, light and materials. Key examples of his work include Calvin Klein's first flagship store in New York, the award-winning Sackler Crossing in Kew's Royal Botanic Gardens and the Cistercian monastery of Our Lady of Novy Dvur in Bohemia. He is currently remodelling the interior of the iconic former Commonwealth Institute in London, scheduled to open as a new permanent home for the Design Museum in 2014.

John Pawson

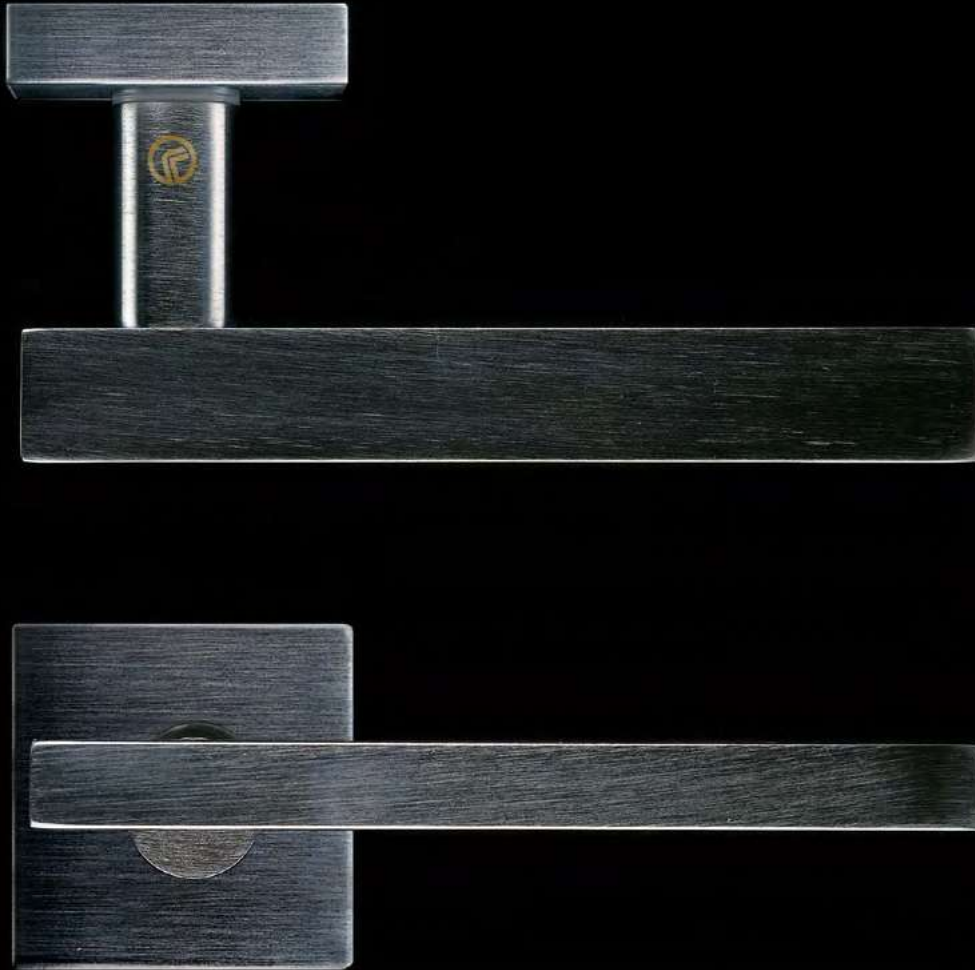

# H 358

Serie **JP 1 Duemila**  
design John Pawson

**Maniglia per porta**  
Door handle

**Materiale Ottone**  
Material Brass

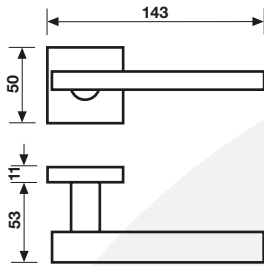

## Finiture

Finishes



Cromo



Cromosat



## H 358 FRS-41

**Maniglia per finestra**  
Window handle

**Movimento**  
**4 scatti**  
Movement  
4 click positions

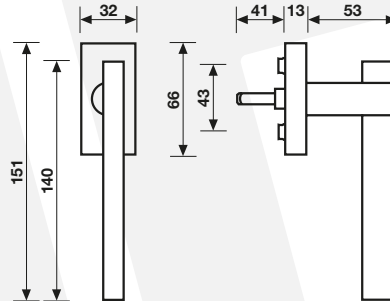

### H 358 R7 / R8

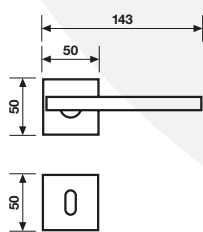

### H 358 R7 Y / R8 Y

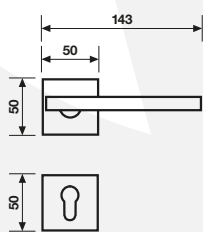

### H 358 RG8 / 8.5

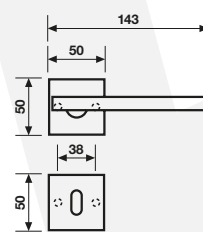

### H 358 RG8 / 8.5 Y

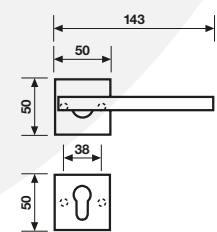

### H 358 RG6-7-8 BZG

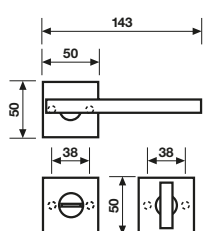

### H 358 RP Passage

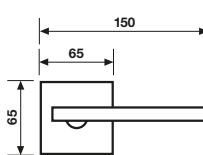

### H 358 RP Privacy

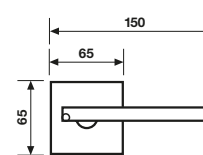

### H 358 RSB

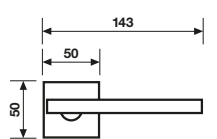

## K 3033

**Bocchetta**  
Escutcheon



**Materiale Nikrall Lega Zama UNI 3717**  
Material Nikrall Lega Zama UNI 3717

**Finiture / Finishes**  
Cromo  
Cromosat

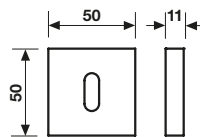

**K 3033**  
Foro chiave normale  
Standard hole  
escutcheon

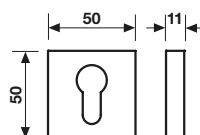

**K 3033 Y**  
Foro chiave cilindro  
Euro-profile hole  
escutcheon

## K 3033 CP

**Bocchetta per RG8**  
Escutcheon for RG8



**Materiale Nikrall Lega Zama UNI 3717**  
Material Nikrall Lega Zama UNI 3717

**Finiture / Finishes**  
Cromo  
Cromosat

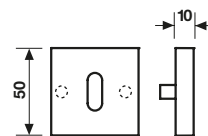

**K 3033 CP**  
Foro chiave normale  
Standard hole  
escutcheon

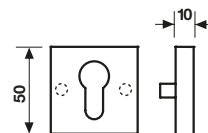

**K 3033 CP Y**  
Foro chiave cilindro  
Euro-profile hole  
escutcheon

## K 3038

**Bocchetta stretta**  
Narrow Escutcheon



**Materiale Ottone**  
Material Brass

**Finiture / Finishes**  
Cromo  
Cromosat

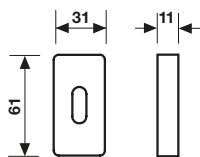

**K 3038**  
Foro chiave normale  
Standard hole  
escutcheon

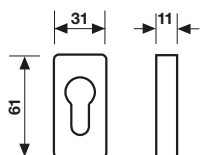

**K 3038 Y**  
Foro chiave cilindro  
Euro-profile hole  
escutcheon

## K 3020

**Materiale Nikrall Lega Zama UNI 3717**  
Material Nikrall Lega Zama UNI 3717

**Finiture / Finishes**  
Cromo  
Cromosat

**Chiusura privacy BZG**  
Bathroom privacy set

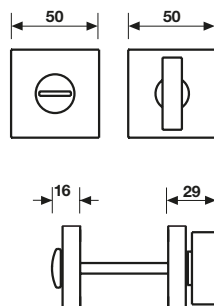

**K 3020 R6-7-8 50 BZG - 85**



## K 3020 RG8

**Materiale Nikrall Lega Zama UNI 3717**  
Material Nikrall Lega Zama UNI 3717

**Finiture / Finishes**  
Cromo  
Cromosat

**Chiusura privacy BZG per RG8**  
Bathroom privacy set for RG8

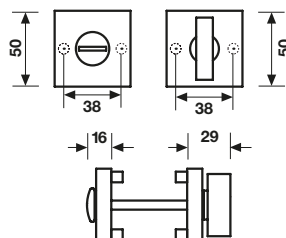

**K 3020 RG6-7-8 50 BZG - 85**



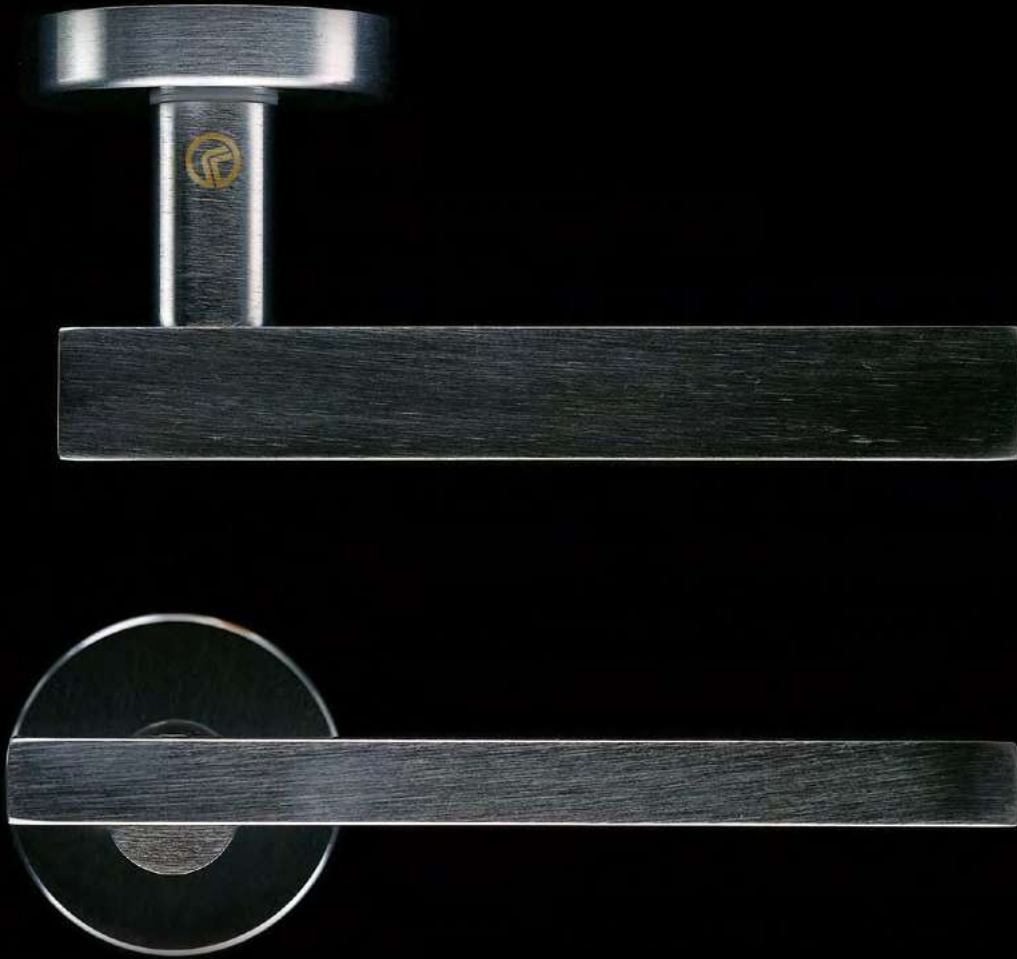

# H 343

Serie **JP Duemila**  
design John Pawson

**Maniglia per porta**  
Door handle

**Materiale Ottone**  
Material Brass

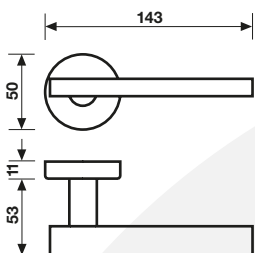

## Finiture

Finishes



Cromo



Cromosat



## H 343 FRS-41

**Maniglia per finestra**  
Window handle

**Movimento**  
**4 scatti**  
Movement  
4 click positions

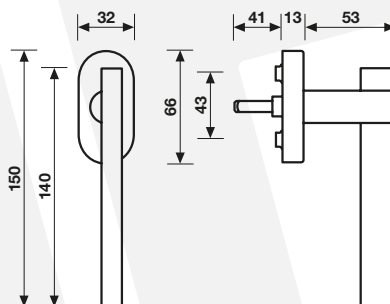

### H 343 R7 / R8

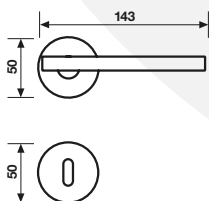

### H 343 R7 Y / R8 Y

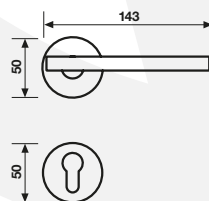

### H 343 RG8 / 8.5

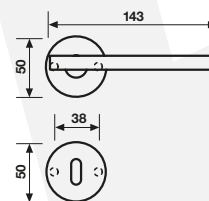

### H 343 RG8 / 8.5 Y

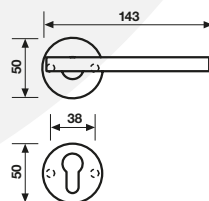

### H 343 RG6-7-8 BZC

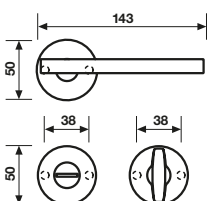

### H 343 RP Passage

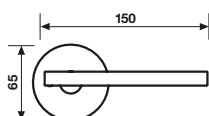

### H 343 RP Privacy

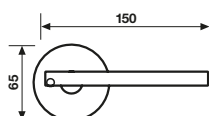

### H 343 RSB

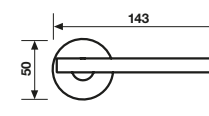



## K 383

**Materiale Ottone**  
Material Brass

**Finiture / Finishes**  
Cromo  
Cromosat

**Bocchetta**  
Escutcheon

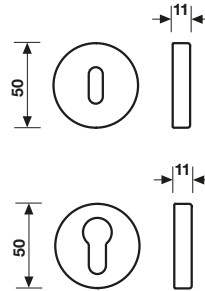

**K 383**  
Foro chiave normale  
Standard hole  
escutcheon

**K 383 Y**  
Foro chiave cilindro  
Euro-profile hole  
escutcheon

## K 3703 CP

**Materiale Ottone**  
Material Brass

**Finiture / Finishes**  
Cromo  
Cromosat

**Bocchetta per RG8**  
Escutcheon for RG8

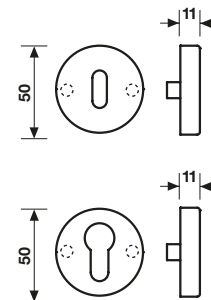

**K 3703 CP**  
Foro chiave normale  
Standard hole  
escutcheon

**K 3703 Y CP**  
Foro chiave cilindro  
Euro-profile hole  
escutcheon

## K 3037

**Materiale Ottone**  
Material Brass

**Finiture / Finishes**  
Cromo  
Cromosat

**Bocchetta stretta**  
Narrow Escutcheon

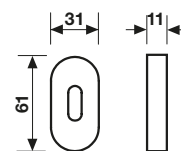

**K 3037**  
Foro chiave normale  
Standard hole  
escutcheon

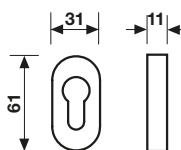

**K 3037 Y**  
Foro chiave cilindro  
Euro-profile hole  
escutcheon

## K 382 50

**Materiale Ottone**  
Material Brass

**Finiture / Finishes**  
Cromo  
Cromosat

**Chiusura privacy BZG**  
Bathroom privacy set

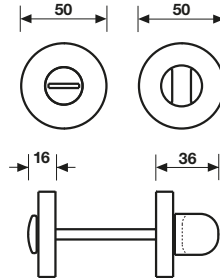

**K 382 R6-7-8 50 BZG - 85**



**K 382 RS6-7-8 50 BZG - 85**



## K 389 RG8

**Materiale Ottone**  
Material Brass

**Finiture / Finishes**  
Cromo  
Cromosat

**Chiusura privacy BZG per RG8**  
Bathroom privacy set for RG8

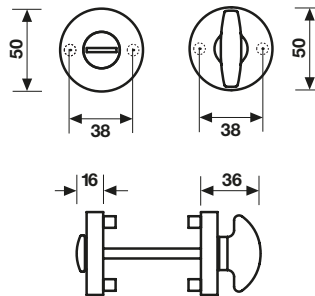

**K 389 RG6-7-8 50 BZG - 75**



## K 356

**Materiale Ottone**  
Material Brass

**Finiture Finishes**  
Cromo  
Cromosat

**Maniglione**  
Pull Handle

**Interasse / Centre distance**  
210 mm

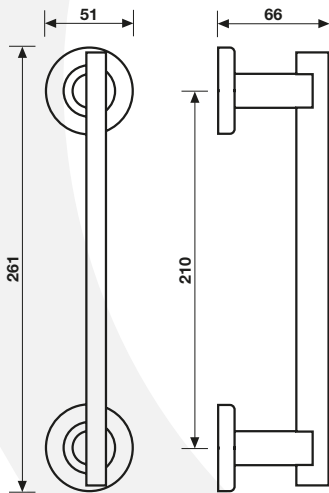

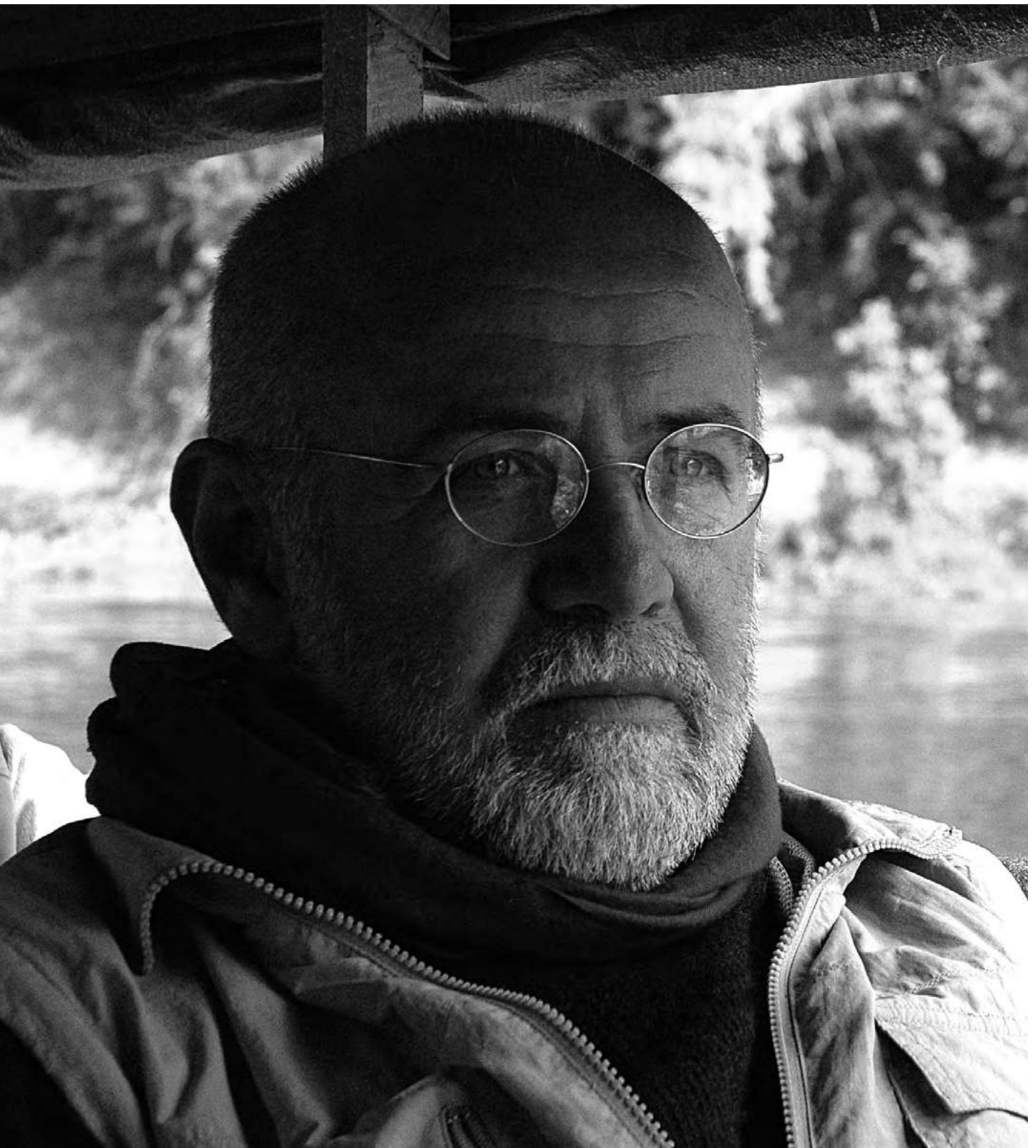

**Nato a Padova nel 1950.**

**Studia arte e architettura a Venezia, nel 1971 incontra l'artista e designer Isamu Noguchi e il grande architetto americano Richard Fuller all'Università Internazionale dell'Arte (U.I.A.) di Venezia. Nel 1974 si dedica professionalmente al design con il primo progetto di industrial Design, un accendigas piezoelettrico per Kalorik, che rimarrà in produzione fino al 2000.**

**Dal 1977 collabora con la Bernini s.p.a. della quale diviene direttore artistico nel 1979, contribuendo al catalogo e all'immagine fino al 2009. Nel 1986 viene chiamato da Franco Moschini per creare (con F. Lenci e G. Talocci) la divisione aereo-navale di Poltrona Frau, l'anno successivo progetta per Frau una fortunata collezione letto di alto contenuto tecnologico e definendo l'aspetto formale della fortunatissima collezione di sedute per ufficio "Forum". Nello stesso anno apre uno studio a Venezia e viene chiamato come "visiting professor" all' U.I.A di Firenze e al Politecnico di Milano dove terrà numerose lezioni e incontri con gli studenti fino a metà degli anni novanta. Nel 1989 viene chiamato all'Accademia di Belle Arti di Venezia per tenere il corso biennale di Design che terrà ininterrottamente fino al 1996. Numerose sue opere sono esposte nei più importanti musei e fondazioni mondiali: The Denver Art Museum, il "Fonds National d'Art Contemporain" di Parigi, il "Magma Museum" di Roccamonfina, la collezione "Farnesina Design" di Roma e il Museo Della Triennale di Milano. Nel 2007 vince il "DesignX Australian Design Award", nel 2005 e 2007 riceve il "Good Design Award" del Chicago Ateneum, nel 2008 riceve la Menzione d'Onore al XXI Compasso D'Oro per la seduta LOOM di Matteograssi. Dal 2007 al 2010 arreda gli spazi di accoglienza delle Biennali d'Arte e Architettura di Venezia: il ristorante delle Corderie dell'Arsenale, il Caffè Italia del padiglione italiano e il Bookshop.**

Franco Poli Born in 1950.

In 1969 he began his studies at the Faculty of Architecture of Venice I.U.A.V.. In 1971 he attended the U.I.A of Venice where he met Richard Fuller and Isamu Noguchi. Since 1977 collaborates with the Bernini s.p.a. of which he became artistic director in 1979, contributing to the catalog and image until 2009. In 1986 he was called by Franco Moschini for the creation of the aircraft division of Poltrona Frau and a "bed system" of high-tech. In the same year he opened a studio in Venice and collaborates as a guest trainer with the U.I.A. of Florence, the C.N.R. and the Politecnico of Milan, in 1989 he was asked to teach the Design course in the Academy of Fine Arts in Venice, a position from which he will resign in 1996. In the nineties, he passionately takes care of the community of Design in Italy and founded several associations of Design, among which the CNAD of Rome and a school of Transnational Mediterranean Design in Reggio Calabria. From 1988 to 2010 he held a series of conferences and meetings on Design in S. Paulo , Quito , Tokyo, Los Angeles , Mexico City, Miami and New York. Since 1995, his "Flying Chair" is in the permanent collection of the " Denver Art Museum ", then numerous creations will be acquired by the " Fonds National d'Art Contemporain " in Paris, the " Magma Museum " in Roccamonfina, the collection " Farnesina Design " of Rome and by the Triennale Museum in Milan. In 2007 he won the " DesignX , Australian Design Award."

In 2005 and 2007 he received the Good Design Award of the Chicago Ateneum . In 2008 he took an Honorable Mention at the XXI Compasso d'Oro for the collection LOOM chair. From 2007 to 2010 furnishes the reception areas Le Bombarde, the Bookshop and Caffè Italia at the Biennale of Art and Architecture Biennale in Venice.

Franco Poli lives and works in Verona.





# H 374

Serie **Compasso Duemilaquattordici**  
design Franco Poli

**Maniglia per porta**  
Door handle

**Materiale Ottone**  
Material Brass

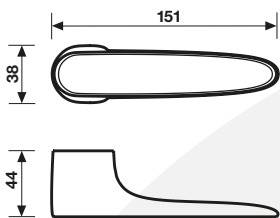

## Finiture

Finishes



Orsatop



Cromosat



Cromoton



Orsatop/Insero grezzo



Cromosat/Insero grezzo



Cromoton/Insero grezzo



Orsatop/Insero gofrato nero



Cromosat/Insero gofrato nero



Cromoton/Insero gofrato nero

## H 374 FRS-41

**Maniglia per finestra**  
Window handle

**Movimento**  
**4 scatti**  
Movement  
4 click positions

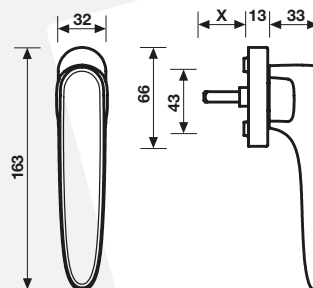

**H 374 R7 / R8**

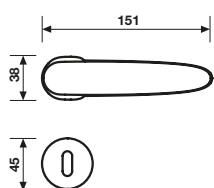

**H 374 R7 Y / R8 Y**

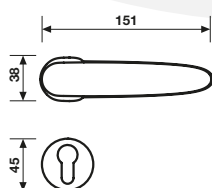

**H 374 RSB**

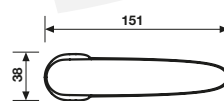



## K 374

**Pomolo per porta**  
Door knob



**Materiale Ottone**  
Material Brass

**Finiture / Finishes**  
Orsatop  
Cromoton  
Cromosat (alluminio)

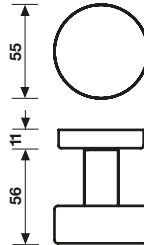

## K 387

**Bocchetta**  
Escutcheon



**Materiale Ottone**  
Material Brass

**Finiture / Finishes**  
Cromosat  
Orsatop  
Cromoton

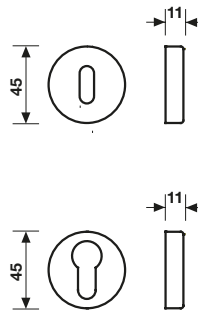

**K 387**  
Foro chiave normale  
Standard hole  
escutcheon

**K 387 Y**  
Foro chiave cilindro  
Euro-profile hole  
escutcheon

## K 3703 CP

**Bocchetta per RG8**  
Escutcheon for RG8



**Materiale Ottone**  
Material Brass

**Finiture / Finishes**  
Cromosat  
Orsatop  
Cromoton

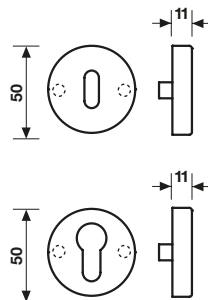

**K 3703 CP**  
Foro chiave normale  
Standard hole  
escutcheon

**K 3703 Y CP**  
Foro chiave cilindro  
Euro-profile hole  
escutcheon

## K 382

**Materiale Ottone**  
Material Brass

**Finiture / Finishes**  
Cromosat  
Orsatop  
Cromoton

**Chiusura privacy BZG**  
Bathroom privacy set

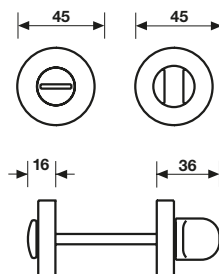

**K 382 R6-7-8 BZG - 85**



**K 382 RS6-7-8 BZG - 85**



## K 389 RG8

**Materiale Ottone**  
Material Brass

**Finiture / Finishes**  
Cromosat  
Orsatop  
Cromoton

**Chiusura privacy BZG per RG8**  
Bathroom privacy set for RG8

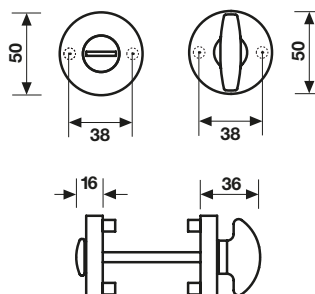

**K 389 RG6-7-8 50 BZG - 75**





**Skidmore, Owings & Merrill LLP riunisce architetti, progettisti, ingegneri, interior designer, manager e designers di mobili e prodotti in un team di colleghi. Questo approccio integrato e collaborativo permette a SOM di distinguersi in maniera sistematica come uno studio in grado di fornire soluzioni progettuali mirate, innovative e significative. Lo Studio SOM di Interior Design non solo realizza interni ma disegna anche mobili e tessuti, cura pezzi d'arte ed accessori, definisce nuovi programmi di spazio, crea ambienti firmati concepiti olisticamente e ricerca processi e paradigmi innovativi.**

---

Skidmore, Owings & Merrill LLP brings together architects, planners, engineers, interior designers, managers and furniture and product designers working as one team. This integrated and collaborative approach allows SOM to consistently distinguish itself as delivering design solutions that are purposeful, innovative, iconic and meaningful. SOM's Interior Design studio not only carries out interior design projects, but also designs furniture and textiles, curates artwork and accessories, defines new spatial programs, creates holistically-conceived branded environments, and researches innovative processes and paradigms.

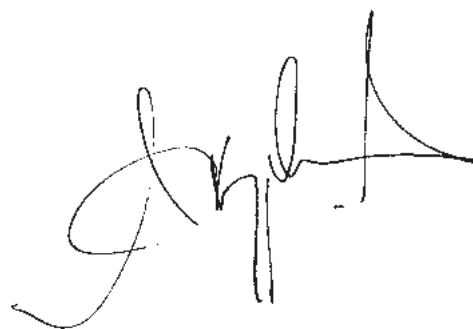

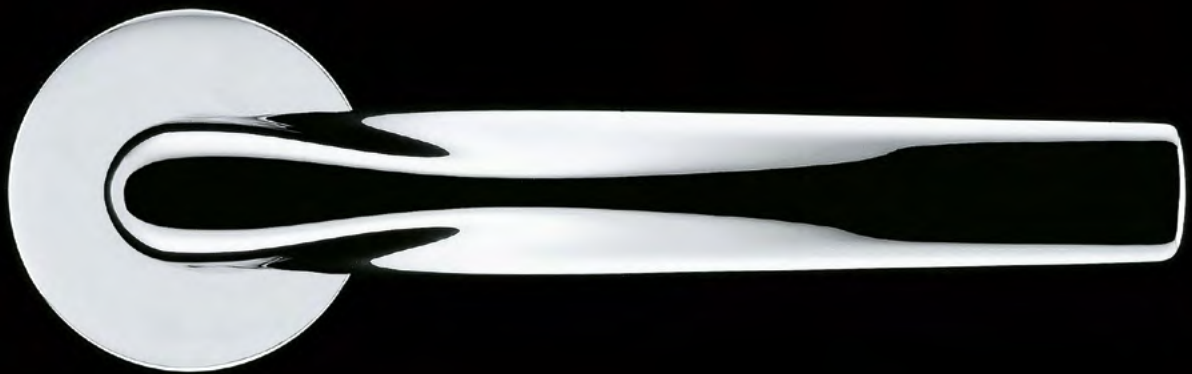

# H 359

Serie **SOM NY Duemilasette**  
design Skidmore, Owings & Merrill

**Maniglia per porta**  
Door handle

**Materiale Ottone**  
Material Brass

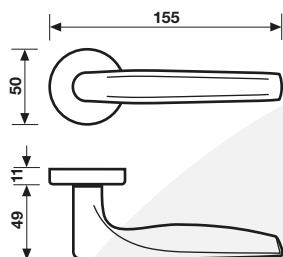

## Finiture

Finishes

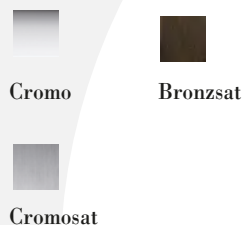

Disponibile anche CLASSE 4 su R8 / RG8  
secondo la norma DIN EN 1906 - Digit 4 7 - 01 - 0 B  
Available also CLASS 4 on R8 / RG8  
according to the DIN Standard EN 1906 - Digit 4 7 - 01 - 0 B

## H 359 FRS-41

**Maniglia per finestra**  
Window handle

**Movimento**  
4 scatti  
Movement  
4 click positions

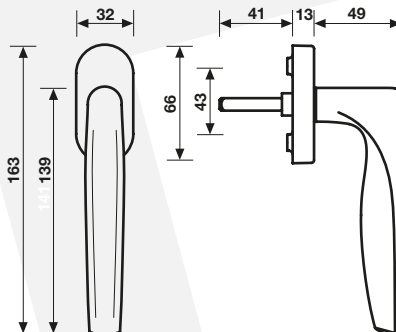

### H 359 R7 / R8

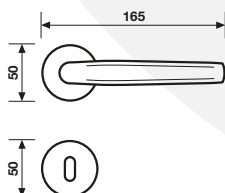

### H 359 R7 Y / R8 Y

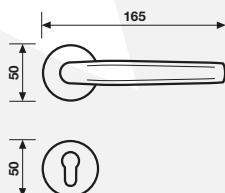

### H 359 RG8 / 8.5

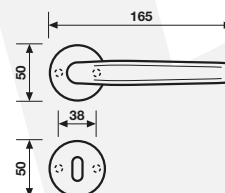

### H 359 RG8 / 8.5 Y

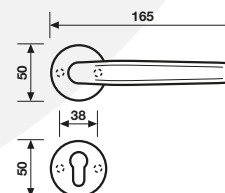

### H 359 RG6-7-8 BZG

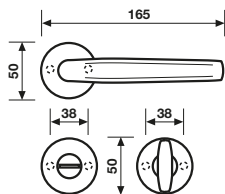

### H 359 RP Passage

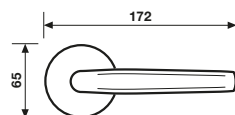

### H 359 RP Privacy

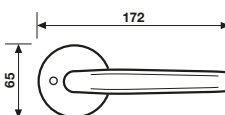

### H 359 RSB

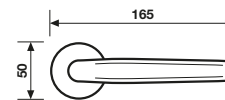

## K 383

**Bocchetta**  
Escutcheon



**Materiale Ottone**  
Material Brass

**Finiture / Finishes**  
Cromo  
Cromosat  
Bronzsat

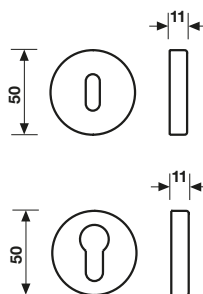

**K 383**  
Foro chiave normale  
Standard hole  
escutcheon

**K 383 Y**  
Foro chiave cilindro  
Euro-profile hole  
escutcheon

## K 3703 CP

**Bocchetta per RG8**  
Escutcheon for RG8



**Materiale Ottone**  
Material Brass

**Finiture / Finishes**  
Cromo  
Cromosat  
Bronzsat

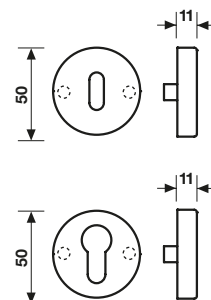

**K 3703 CP**  
Foro chiave normale  
Standard hole  
escutcheon

**K 3703 Y CP**  
Foro chiave cilindro  
Euro-profile hole  
escutcheon

## K 3037

**Bocchetta stretta**  
Narrow Escutcheon



**Materiale Ottone**  
Material Brass

**Finiture / Finishes**  
Cromo  
Cromosat  
Bronzsat

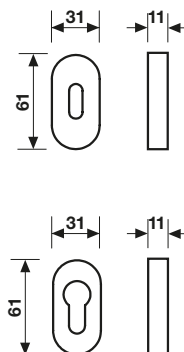

**K 3037**  
Foro chiave normale  
Standard hole  
escutcheon

**K 3037 Y**  
Foro chiave cilindro  
Euro-profile hole  
escutcheon

## K 382 50

**Materiale Ottone**  
Material Brass

**Finiture / Finishes**  
Cromo  
Cromosat  
Bronzsat

**Chiusura privacy BZG**  
Bathroom privacy set

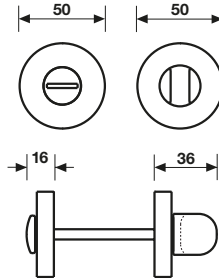

**K 382 R6-7-8 50 BZG - 85**



**K 382 RS6-7-8 50 BZG - 85**



## K 389 RG8

**Materiale Ottone**  
Material Brass

**Finiture / Finishes**  
Cromo  
Cromosat  
Bronzsat

**Chiusura privacy BZG per RG8**  
Bathroom privacy set for RG8

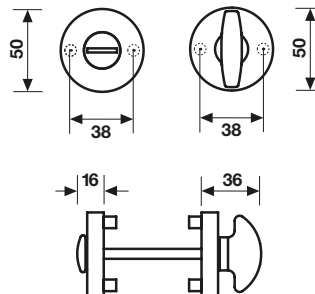

**K 389 RG6-7-8 50 BZG - 75**





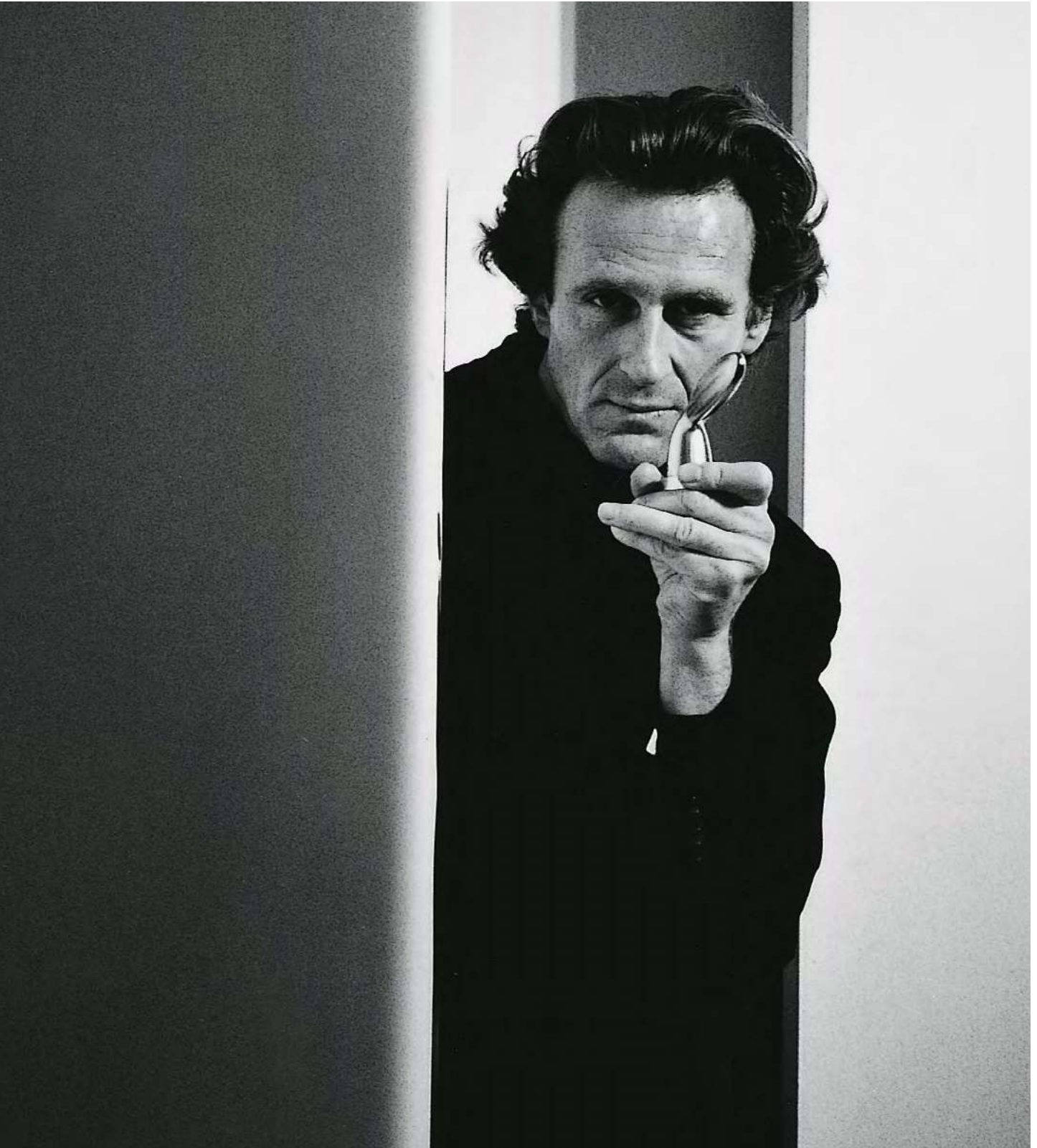

**Architetto e designer, nasce a Bolzano nel 1952. Studia all'Accademia di Salisburgo con Oskar Kokoschka e Emilio Vedova e nel 1975 si laurea in architettura a Firenze. Partner dello studio Ettore Sottsass Associati, nel 1981 partecipa alla fondazione del gruppo Memphis. Dal 1990 al 1993 è Art Director di Swatch. Membro della Royal Association of British Architects, è stato insignito dei più prestigiosi riconoscimenti internazionali. Nel 1984 apre il proprio studio a Milano dove, nel 2001 fonda la Matteo Thun & Partners, con cui sviluppa design di prodotto e progetti di architettura dalla piccola alla grande scala.**

---

Architect and designer, born in Bolzano in 1952. He studied at the Salzburg Academy under Oskar Kokoschka and Emilio Vedova and in 1975 he graduated in architecture in Florence. Partner of Ettore Sottsass Associati in 1981 co-founded the Memphis group. From 1990 to 1993 he was Art Director of Swatch. Member of the Royal Association of British Architects, was awarded of the most prestigious international awards. In 1984 he opened his own studio in Milan, where in 2001 he founded Matteo Thun & Partners, which develops product design and architecture projects from small to large scale.





# H 330

Serie T Novantasette  
design Matteo Thun

**Maniglia per porta**  
Door handle

**Materiale Ottone**  
Material Brass

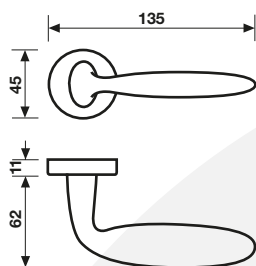

## Finiture

Finishes



Cromosat

## H 330 FRS-41

**Maniglia per finestra**  
Window handle

**Movimento**  
4 scatti  
Movement  
4 click positions

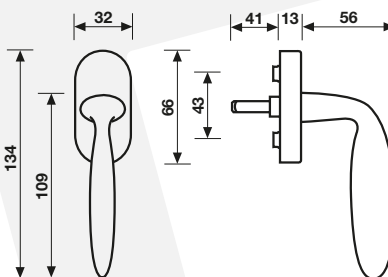

Disponibile anche CLASSE 4 su R8 / RG8  
secondo la norma DIN EN 1906 - Digit 4 7 - 0 1 - 0 B  
Available also CLASS 4 on R8 / RG8  
according to the DIN Standard EN 1906 - Digit 4 7 - 0 1 - 0 B

### H 330 R7 / R8

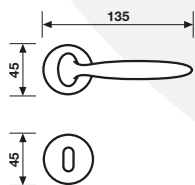

### H 330 R7 Y / R8 Y

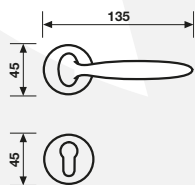

### H 330 RG8 / 8.5

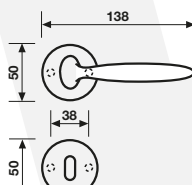

### H 330 RG8 / 8.5 Y

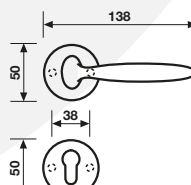

### H 330 RG6-7-8 BZG

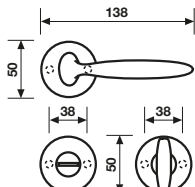

### H 330 RP Passage

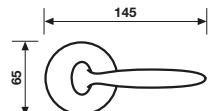

### H 330 RP Privacy

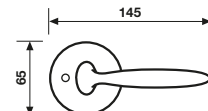

### H 330 RSB

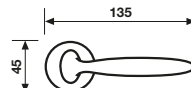

## K 387

**Materiale Ottone**  
Material Brass

**Finiture / Finishes**  
Cromosat

**Bocchetta**  
Escutcheon

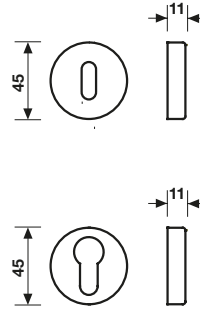

**K 387**  
Foro chiave normale  
Standard hole  
escutcheon

**K 387 Y**  
Foro chiave cilindro  
Euro-profile hole  
escutcheon

## K 3703 CP

**Materiale Ottone**  
Material Brass

**Finiture / Finishes**  
Cromosat

**Bocchetta per RG8**  
Escutcheon for RG8

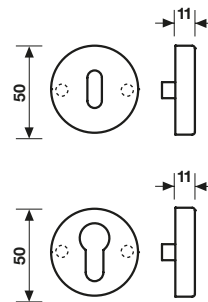

**K 3703 CP**  
Foro chiave normale  
Standard hole  
escutcheon

**K 3703 Y CP**  
Foro chiave cilindro  
Euro-profile hole  
escutcheon

## K 3037

**Materiale Ottone**  
Material Brass

**Finiture / Finishes**  
Cromosat

**Bocchetta stretta**  
Narrow Escutcheon

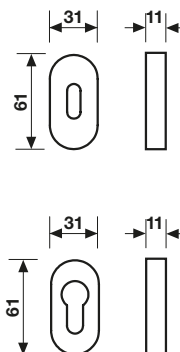

**K 3037**  
Foro chiave normale  
Standard hole  
escutcheon

**K 3037 Y**  
Foro chiave cilindro  
Euro-profile hole  
escutcheon

## K 382

**Materiale Ottone**  
Material Brass

**Finiture / Finishes**  
Cromosat

**Chiusura privacy BZG**  
Bathroom privacy set

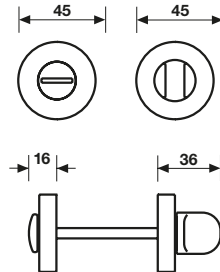

**K 382 R6-7-8 BZG - 85**



**K 382 RS6-7-8 BZG - 85**



## K 389 RG8

**Materiale Ottone**  
Material Brass

**Finiture / Finishes**  
Cromosat

**Chiusura privacy BZG per RG8**  
Bathroom privacy set for RG8

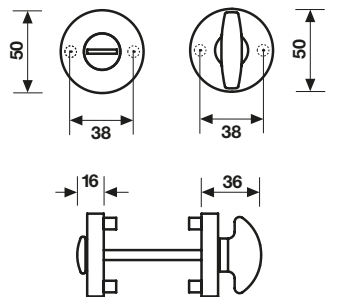

**K 389 RG6-7-8 50 BZG - 75**





**Marco Triaca ha seguito e coordinato lo sviluppo delle maniglie Fusital negli ultimi 15 anni. Un'esperienza che egli stesso definisce "edificante" e che l'ha condotto a oltrepassare l'aspetto strettamente ingegneristico del progetto per andare alla ricerca di una percezione più emotiva. Anche in un oggetto apparentemente "freddo" come una maniglia, infatti, secondo Marco è fondamentale ricercare "l'anima" ovvero quella dimensione creativa ed emozionale che sia in grado di far convivere in un equilibrio perfetto design, ergonomia, materiali e tecnica.**

**"Partendo da questo presupposto - spiega Triaca - disegnare una maniglia per Fusital è stata una casualità, o forse una conseguenza..." "Sono un ingegnere e del design ho fatto la mia forza". Il nodo centrale per me è stato riuscire a coniugare modernità e tradizione".**

---

Marco Triaca has been the supervisor and the coordinator of Fusital handle development over the last 15 years. An experience for him very "enriching" that helped him going beyond the mere engineering project aspect looking for a more emotional perception. Marco is in fact convinced that even in an apparently "cold" object like a handle, it is very important to find out "the soul", that is a creative and emotional dimension matching together in a perfect balance design, ergonomics, materials and technique.

"With this in mind - Triaca explains - it was for me a fluke... or a consequence ... to design a Fusital handle. I'm an engineer, but I made of design my strength. Crucial for me was the successful combination of modernism and tradition".

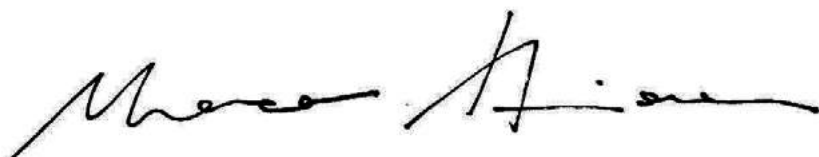





# H 375

Serie MT Duemilaquattordici  
design Marco Triaca

**Maniglia per porta**  
Door handle

**Materiale Ottone**  
Material Brass

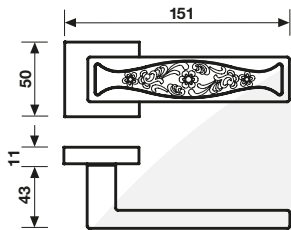

## Finiture

Finishes



Biancopaco



Biancopaco/Fiore oro



Tortora



Tortora/Fiore oro



Brunito



Brunito/Fiore oro



### H 375 R7 / R8

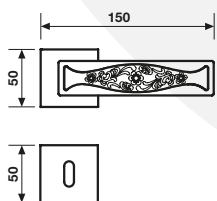

### H 375 R7 Y / R8 Y

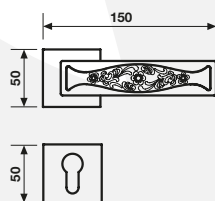

### H 375 RG8 / 8.5

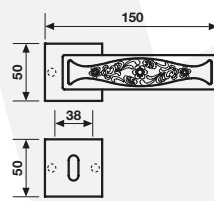

### H 375 RG8 / 8.5 Y

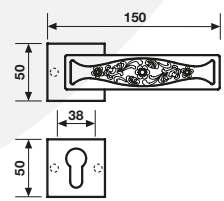

### H 375 RG6-7-8 BZG

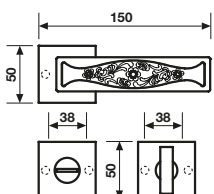

### H 375 RP Passage

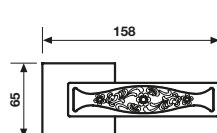

### H 375 RP Privacy

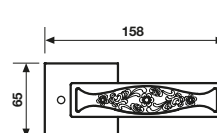

### H 375 RSB

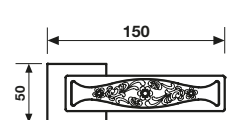

**Materiale Ottone**  
Material Brass

**Finiture / Finishes**  
Biancopaco  
Tortora  
Brunito  
Biancopaco/Fiore oro  
Tortora/Fiore oro  
Brunito/Fiore oro

**H 375 FRS-41**

**Maniglia per finestra**  
Window handle

**Movimento**  
**4 scatti**  
Movement  
4 click positions

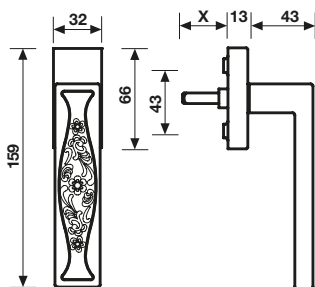

**K 375**

**Pomolo per porta**  
Door knob

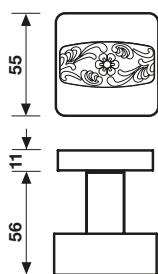

**Materiale Ottone / Alluminio**  
Material Brass / Aluminium

**Finiture / Finishes**  
Biancopaco  
Tortora  
Brunito (Ottone)  
Biancopaco/Fiore oro  
Tortora/Fiore oro  
Brunito/Fiore oro (ottone)



# K 375

Serie **MT Duemilaquattordici**  
design Marco Triaca

## Materiale Ottone

Material Brass

## Finiture / Finishes

Biancopaco

Tortora

Brunito

Biancopaco/Fiore oro

Tortora/Fiore oro

Brunito/Fiore oro

# K 375

## Maniglione

Pull Handle

## Interasse / Centre distance

250 mm

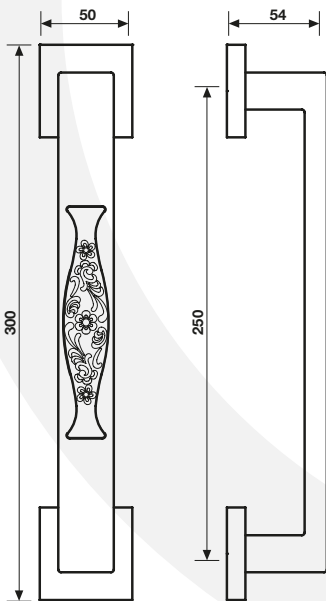

## K 3033

**Bocchetta**  
Escutcheon



**Materiale Nikrall Lega Zama UNI 3717**  
Material Nikrall Lega Zama UNI 3717

**Finiture / Finishes**  
Biancopaco  
Tortora  
Brunito

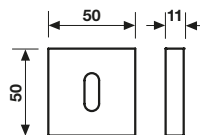

**K 3033**  
Foro chiave normale  
Standard hole  
escutcheon

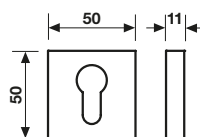

**K 3033 Y**  
Foro chiave cilindro  
Euro-profile hole  
escutcheon

## K 3033 CP

**Bocchetta per RG8**  
Escutcheon for RG8



**Materiale Nikrall Lega Zama UNI 3717**  
Material Nikrall Lega Zama UNI 3717

**Finiture / Finishes**  
Biancopaco  
Tortora  
Brunito

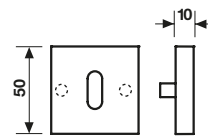

**K 3033 CP**  
Foro chiave normale  
Standard hole  
escutcheon

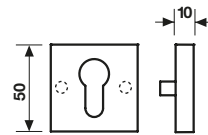

**K 3033 CP Y**  
Foro chiave cilindro  
Euro-profile hole  
escutcheon

## K 3038

**Bocchetta stretta**  
Narrow Escutcheon



**Materiale Ottone**  
Material Brass

**Finiture / Finishes**  
Biancopaco  
Tortora  
Brunito

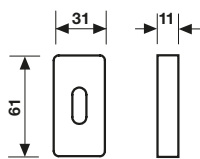

**K 3038**  
Foro chiave normale  
Standard hole  
escutcheon

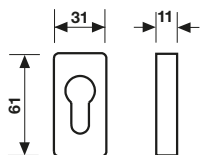

**K 3038 Y**  
Foro chiave cilindro  
Euro-profile hole  
escutcheon

## K 3020

**Materiale Nikrall Lega Zama UNI 3717**  
Material Nikrall Lega Zama UNI 3717

**Finiture / Finishes**  
Biancopaco  
Tortora  
Brunito

**Chiusura privacy BZG**  
Bathroom privacy set

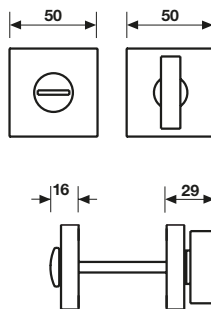

**K 3020 R6-7-8 50 BZG - 85**



## K 3020 RG8

**Materiale Nikrall Lega Zama UNI 3717**  
Material Nikrall Lega Zama UNI 3717

**Finiture / Finishes**  
Biancopaco  
Tortora  
Brunito

**Chiusura privacy BZG per RG8**  
Bathroom privacy set for RG8

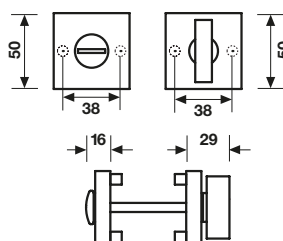

**K 3020 RG6-7-8 50 BZG - 85**



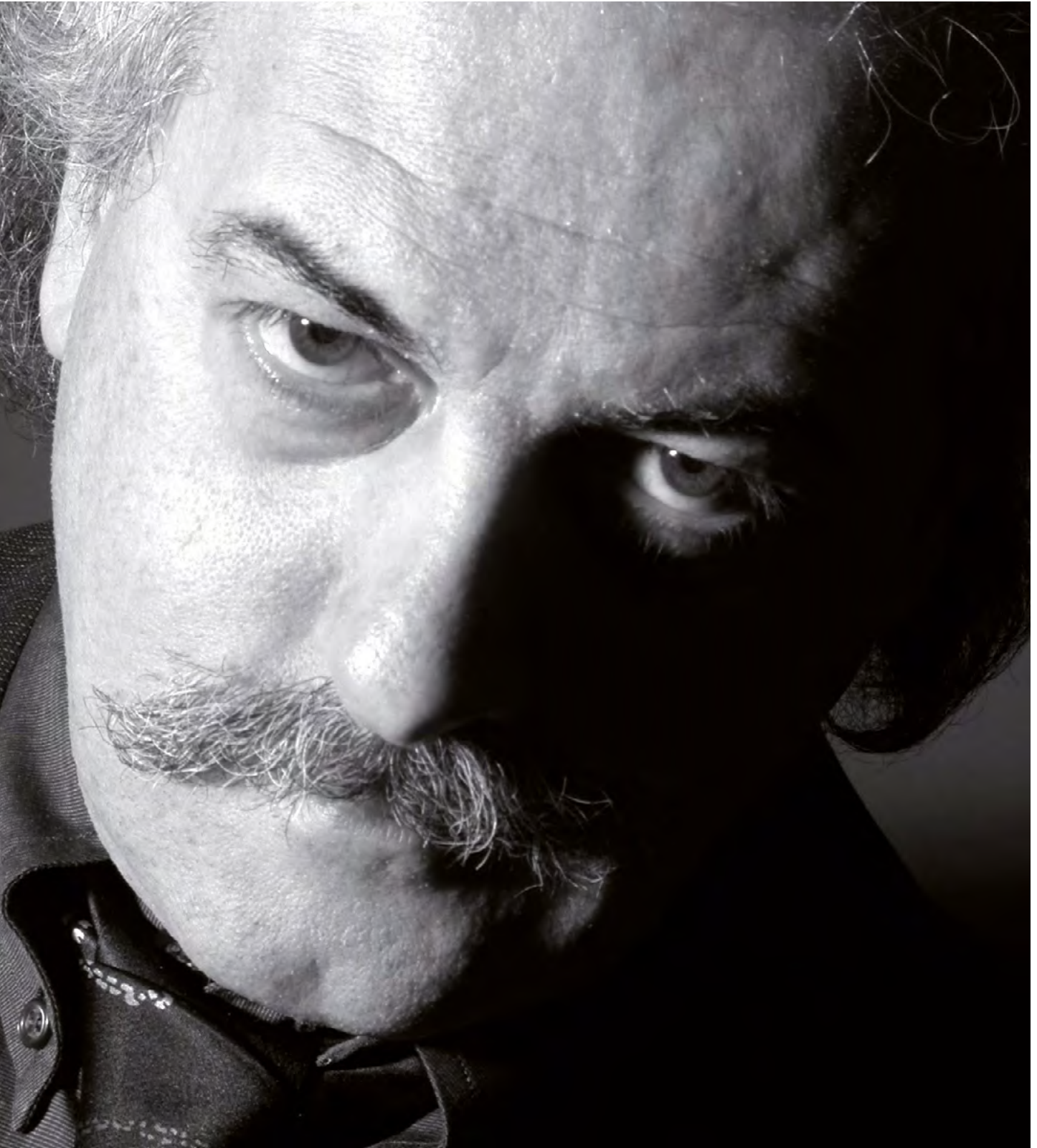

**Classe '49 si forma presso l'Istituto d'Arte di Cascina. Dal 1968 al 1975 collabora con Ferretti Cucine. Vegni Design è l'inizio del suo percorso professionale una carriera ricca di collaborazioni importanti, riconoscimenti, successi. Con il programma Misura di Effeti Cucine firma il primo blocco funzione tondo nella storia della cucina (1988); Duetto di Officine Star partecipa alle selezioni per il Compasso d'Oro (1991). Le opere spaziano ogni campo del design, caratterizzate da un tratto pulito, la predilizione per il tondo, uno stile squisitamente made in Italy apprezzato in tutto il mondo.**

---

Born in 1946, he completed his studies at the Art Institute of Cascina. From 1968 till 1975 he collaborated with Ferretti Cucine. By founding Vegni Design, he started his professional career with plenty of important cooperations, awards and successful designs. With his Misura Program for Effeti Cucine he created the first round functional element in the history of the kitchen (1988); Duetto for Officine Star was selected for the Compasso D'Oro Award (1991). His works develop all the design features and portray clean lines and preferably round shapes: an exquisitely Made in Italy style, highly appreciated all over the world.







# H 376

Serie **GV Duemilaquattordici**  
design Giancarlo Vegni

**Maniglia per porta**  
Door handle

**Materiale Ottone**  
Material Brass

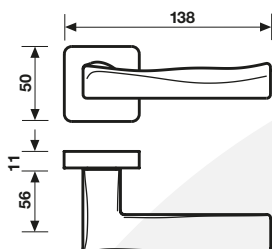

## Finiture

Finishes



Cromo



Cromosat



Cromo/Cromosat

## H 376 FRS-41

**Maniglia per finestra**  
Window handle

**Movimento**  
**4 scatti**  
Movement  
4 click positions

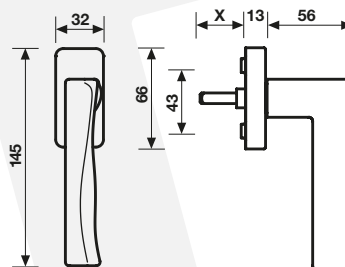

Disponibile anche CLASSE 4 su R8 / RG8  
secondo la norma DIN EN 1906 - Digit 4 7 - 01 - 0 B  
Available also CLASS 4 on R8 / RG8  
according to the DIN Standard EN 1906 - Digit 4 7 - 01 - 0 B

### H 376 R7 / R8

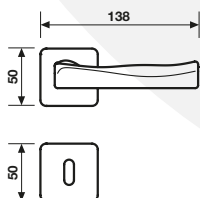

### H 376 R7 Y / R8 Y

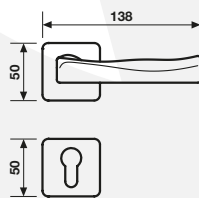

### H 376 RG8 / 8.5

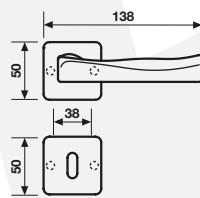

### H 376 RG8 / 8.5 Y

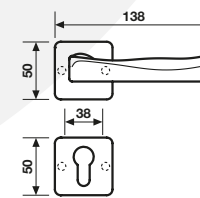

### H 376 RG6-7-8 BZG

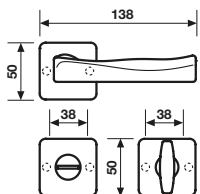

### H 376 RP Passage

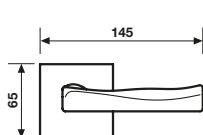

### H 376 RP Privacy

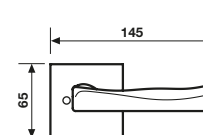

### H 376 RSB

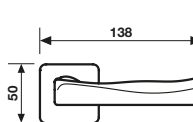

## K 376

**Pomolo per porta**  
Door knob



**Materiale Alluminio**  
Material Aluminium

**Finiture / Finishes**  
Cromo  
Cromosat  
Cromo / Cromosat

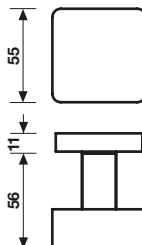

## K 3034

**Bocchetta**  
Escutcheon



**Materiale Nikrall Lega Zama UNI 3717**  
Material Nikrall Lega Zama UNI 3717

**Finiture / Finishes**  
Cromo  
Cromosat

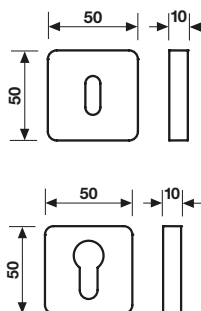

**K 3034**  
Foro chiave normale  
Standard hole  
escutcheon

**K 3034 Y**  
Foro chiave cilindro  
Euro-profile hole  
escutcheon

## K 3034 CP

**Bocchetta per RG8**  
Escutcheon for RG8



**Materiale Nikrall Lega Zama UNI 3717**  
Material Nikrall Lega Zama UNI 3717

**Finiture / Finishes**  
Cromo  
Cromosat

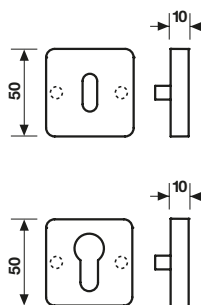

**K 3034 CP**  
Foro chiave normale  
Standard hole  
escutcheon

**K 3034 CP Y**  
Foro chiave cilindro  
Euro-profile hole  
escutcheon

## K 3038

**Materiale Ottone**  
Material Brass

**Finiture / Finishes**  
Cromo  
Cromosat

**Bocchetta stretta**  
Narrow Escutcheon

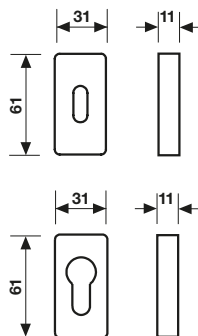
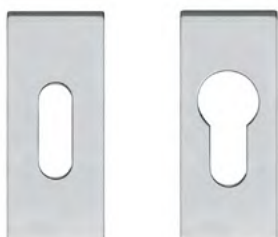

**K 3038**  
Foro chiave normale  
Standard hole  
escutcheon

**K 3038 Y**  
Foro chiave cilindro  
Euro-profile hole  
escutcheon

## K 3029 50

**Materiale Ottone**  
Material Brass

**Finiture / Finishes**  
Cromo  
Cromosat

**Chiusura privacy BZG**  
Bathroom privacy set

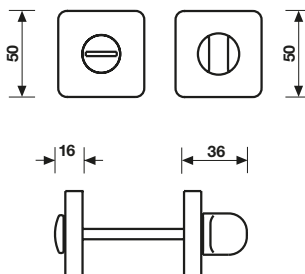

**K 3029 R6-7-8 50 BZG - 85**



## K 3029 RG8

**Materiale Ottone**  
Material Brass

**Finiture / Finishes**  
Cromo  
Cromosat

**Chiusura privacy BZG per RG8**  
Bathroom privacy set for RG8

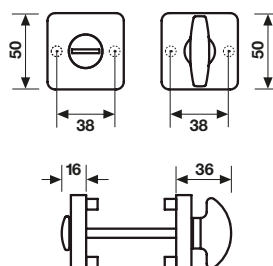

**K 3029 RG6-7-8 50 BZG - 75**



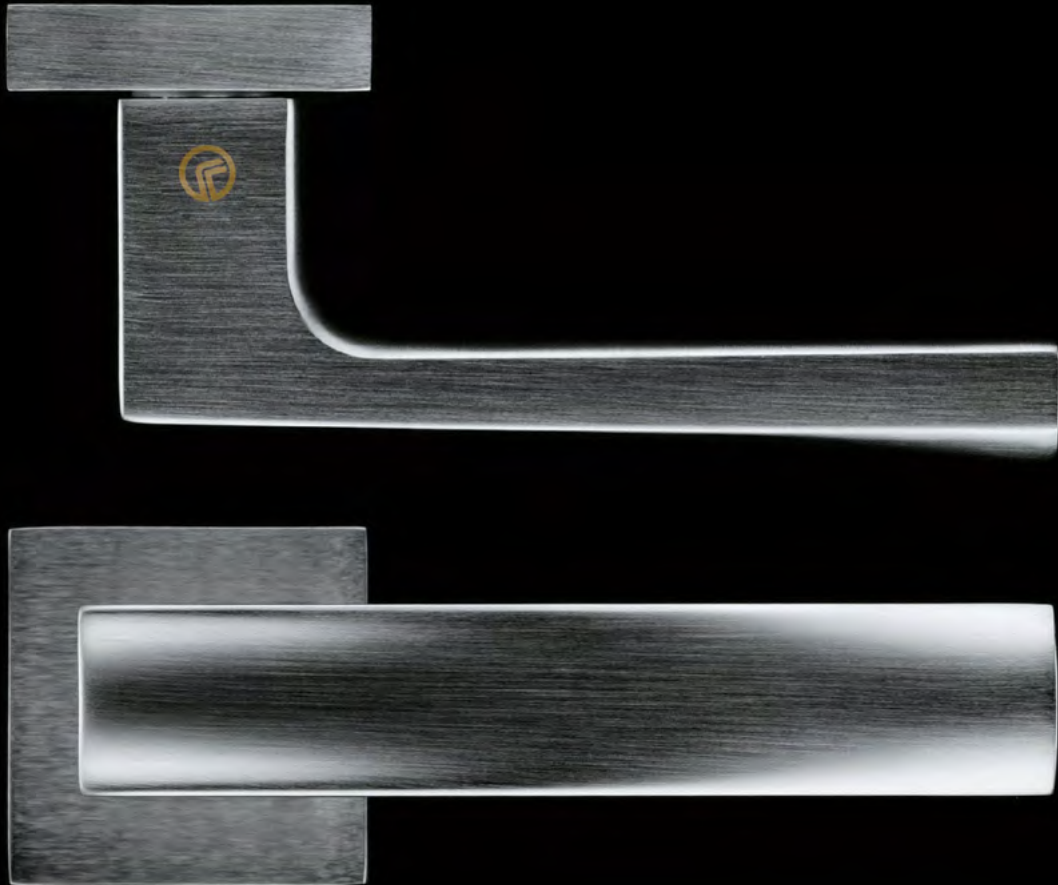

# H 367

Serie **GV Duemilanove**  
design Giancarlo Vegni

**Maniglia per porta**  
Door handle

**Materiale Ottone**  
Material Brass

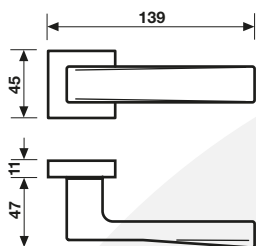

## Finiture

Finishes



Cromo



Cromosat



Disponibile anche CLASSE 4 su R8 / RG8  
secondo la norma DIN EN 1906 - Digit 4 7 - 0 1 - 0 B  
Available also CLASS 4 on R8 / RG8  
according to the DIN Standard EN 1906 - Digit 4 7 - 0 1 - 0 B

## H 367 FRS-41

**Maniglia per finestra**  
Window handle

**Movimento**  
4 scatti  
Movement  
4 click positions

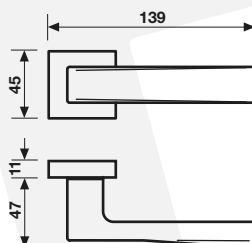

### H 367 R7 / R8

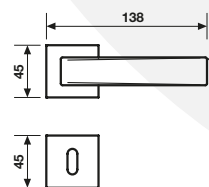

### H 367 R7 Y / R8 Y

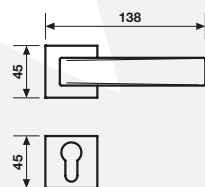

### H 367 RG8 / 8.5

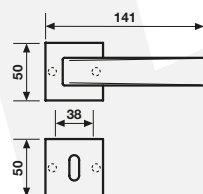

### H 367 RG8 / 8.5 Y

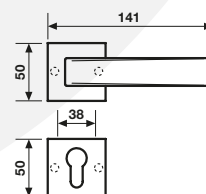

### H 367 RG6-7-8 BZG

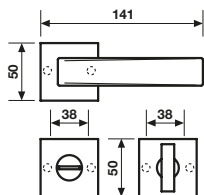

### H 367 RP Passage

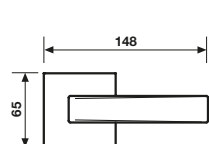

### H 367 RP Privacy

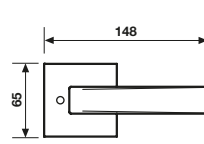

### H 367 RSB

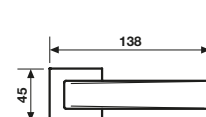

## K 3031

**Bocchetta**  
Escutcheon



**Materiale Nikrall Lega Zama UNI 3717**  
Material Nikrall Lega Zama UNI 3717

**Finiture / Finishes**  
Cromo  
Cromosat

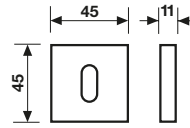

**K 3031**  
Foro chiave normale  
Standard hole  
escutcheon

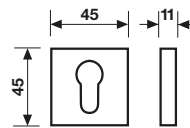

**K 3031 Y**  
Foro chiave cilindro  
Euro-profile hole  
escutcheon

## K 3033 CP

**Bocchetta per RG8**  
Escutcheon for RG8



**Materiale Nikrall Lega Zama UNI 3717**  
Material Nikrall Lega Zama UNI 3717

**Finiture / Finishes**  
Cromo  
Cromosat

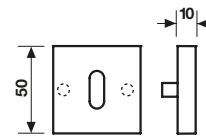

**K 3033 CP**  
Foro chiave normale  
Standard hole  
escutcheon

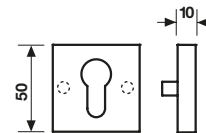

**K 3033 CP Y**  
Foro chiave cilindro  
Euro-profile hole  
escutcheon

## K 3038

**Bocchetta stretta**  
Narrow Escutcheon

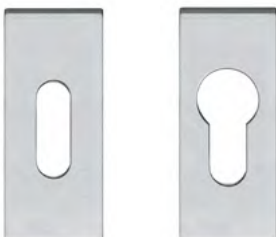

**Materiale Ottone**  
Material Brass

**Finiture / Finishes**  
Cromo  
Cromosat

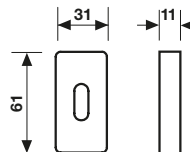

**K 3038**  
Foro chiave normale  
Standard hole  
escutcheon

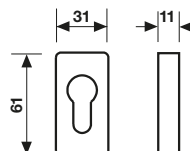

**K 3038 Y**  
Foro chiave cilindro  
Euro-profile hole  
escutcheon

## K 3013

**Materiale Ottone**  
Material Brass

**Finiture / Finishes**  
Cromo  
Cromosat

**Chiusura privacy BZG**  
Bathroom privacy set

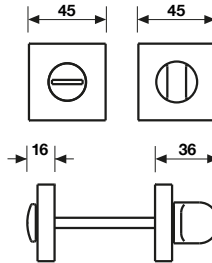

**K 3013 R6-7-8 BZG**



## K 3020 RG8

**Materiale Nikrall Lega Zama UNI 3717**  
Material Nikrall Lega Zama UNI 3717

**Finiture / Finishes**  
Cromo  
Cromosat

**Chiusura privacy BZG per RG8**  
Bathroom privacy set for RG8

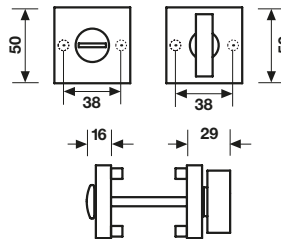

**K 3020 RG6-7-8 50 BZG - 85**







**Lo studio Yabu Pushelberg, con uffici a Toronto e New York, è stato fondato nel 1980 da George Yabu e Glenn Pushelberg. L'inesorabile curiosità dei soci ha spinto l'innovativa e multidisciplinare società di design all'avanguardia del proprio settore, lavorando nell'arredamento di interni (nel settore hotels, residenziale e privato) nell'industria del mobile, del tessile, dell'illuminazione e della posateria. Ogni nuovo progetto riflette un diverso approccio che è immaginativo, riflessivo e raffinato - tra il razionale e l'intuitivo.**

---

With offices in Toronto and New York, Yabu Pushelberg was established in 1980 by George Yabu and Glenn Pushelberg. The principals' relentless curiosity has propelled the innovative and multidisciplinary design firm to the forefront of its industry, working across interiors (residential, retail, and hospitality) as well as furniture, textiles, lighting, and tableware. Each new venture reflects an edited approach that is imaginative, thoughtful and refined – shifting between the rational and the intuitive.

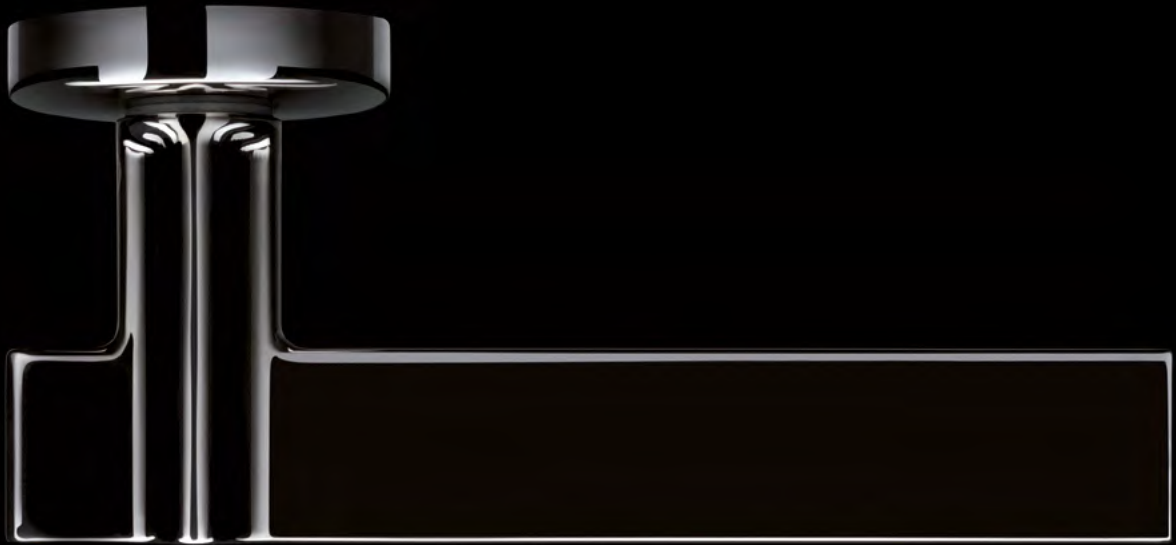

# H 378

Serie YP Duemiladiciotto  
design Yabu Pushelberg

**Maniglia per porta**  
Door handle

**Materiale Ottone**  
Material Brass

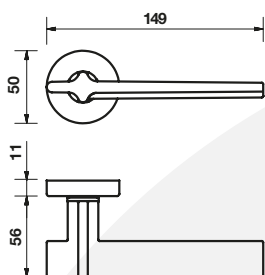

## Finiture

Finishes



Cromo



Bronzo scuro



Light black



Rame



### H 378 R7 / R8

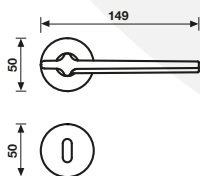

### H 378 R7 Y / R8 Y

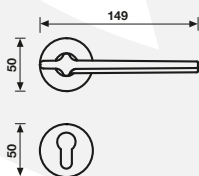

### H 378 RG8 / 8.5

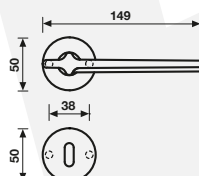

### H 378 RG8 / 8.5 Y

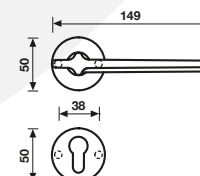

### H 378 RG6-7-8 BZG

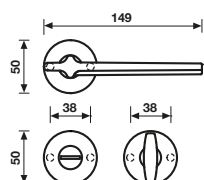

### H 378 RP Passage

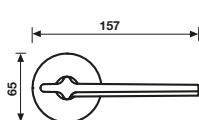

### H 378 RP Privacy

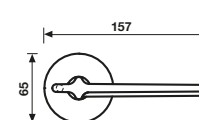

### H 378 RSB

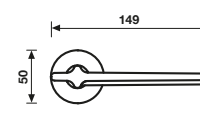

**Materiale Ottone**  
Material Brass

**Finiture Finishes**  
Cromo  
Bronzo scuro  
Light black  
Rame

**H 378 FRS-41**

**Maniglia per finestra**  
Window handle

**Movimento**  
**4 scatti**  
Movement  
4 click positions

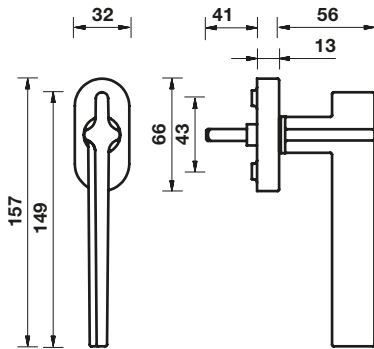

# K 378

Serie YP Duemiladiciotto  
design Yabu Pushelberg

## Materiale Ottone

Material Brass

## Finiture Finishes

Cromo  
Bronzo scuro  
Light black  
Rame

## K 378

### Maniglione

Pull Handle

### Interasse / Centre distance

300 mm

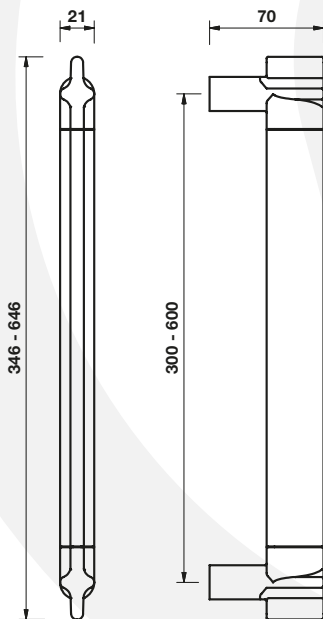

## K 378

**Pomolo per porta**  
Door knob



**Materiale Ottone**  
Material Brass

**Finiture / Finishes**  
Cromo  
Bronzo scuro  
Light black  
Rame

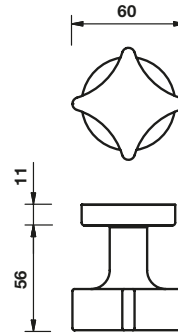

**K 378 R8 / K 378 R8 Y**

## K 383

**Bocchetta**  
Escutcheon



**Materiale Ottone**  
Material Brass

**Finiture / Finishes**  
Cromo  
Bronzo scuro  
Light black  
Rame

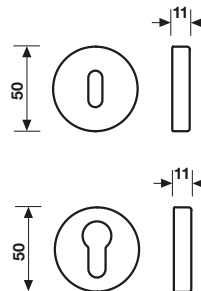

**K 383**  
Foro chiave normale  
Standard hole  
escutcheon

**K 383 Y**  
Foro chiave cilindro  
Euro-profile hole  
escutcheon

## K 382

**Chiusura privacy BZG**  
Bathroom privacy set



**Materiale Ottone**  
Material Brass

**Finiture / Finishes**  
Cromo  
Bronzo scuro  
Light black  
Rame

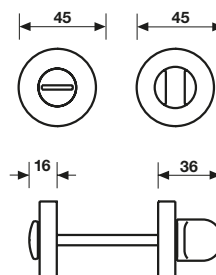

**K 382 R6-7-8 BZG - 85**

**K 382 RS6-7-8 BZG - 85**

## K 389 RG8

**Materiale Ottone**  
Material Brass

**Finiture / Finishes**  
Cromo  
Bronzo scuro  
Light black  
Rame

**Chiusura privacy BZG**  
Bathroom privacy set

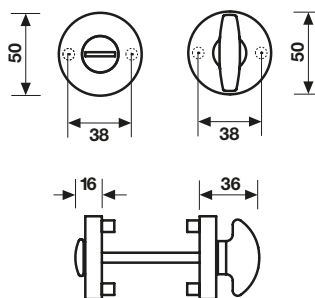

**K 389 RG6-7-8 50 BZG - 75**



## K 3703 CP

**Materiale Ottone**  
Material Brass

**Finiture / Finishes**  
Cromo  
Bronzo scuro  
Light black  
Rame

**Bocchetta per RG8**  
Escutcheon for RG8

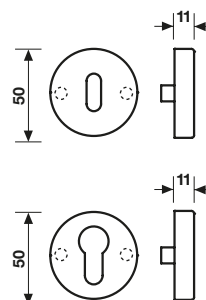

**K 3703 CP**  
Foro chiave normale  
Standard hole  
escutcheon

**K 3703 Y CP**  
Foro chiave cilindro  
Euro-profile hole  
escutcheon





**H 373** ●  
Serie **DOB Duemiladodici**  
design Dante O. Benini e Luca Gonzo

Pag. 234



**H 371** ▲  
Serie **LK Duemiladieci**  
design Leon Krier

Pag. 234



**H 360** ■  
Serie **FN Duemilasette**  
design Fabio Novembre

Pag. 235



**H 353** \*  
Serie **AC3 Duemilaquattro**  
design Antonio Citterio con Tpoan Nguyen

Pag. 235



**H 351** ▲  
Serie **AR Duemiladue**  
design Alan Ritchie - Philip Johnson Architects

Pag. 236



**H 349** ▲  
Serie **CWL Duemiladue**  
design Chi Wing Lo

Pag. 236



**H 347** ▲  
Serie **MDF Duemiladue**  
design Massimiliano e Doriana Fuksas

Pag. 237



**H 345** ●  
Serie **LK Duemilauno**  
design Leon Krier

Pag. 237



**H 344** ▲  
Serie **JN Duemilauno**  
design Jean Nouvel

Pag. 238



**H 342** ■  
Serie **RA Duemila**  
design Ron Arad

Pag. 238



**H 340** ■  
Serie **HK Duemila**  
design Hans Kollhoff

Pag. 239



**H 339** ▲  
Serie **AP Duemila**  
design Andrée Putman

Pag. 239



**H 337** ■  
Serie **GP Novantotto**  
design Gustav Peichl

Pag. 240



**H 333** ■  
Serie **P Novantotto**  
design Piano design Workshop

Pag. 240



**H 331** ▲  
Serie **MG Novantotto**  
design Micael Graves

Pag. 241



**H 328** ●  
Serie **NF Novantacinque**  
design Norman Foster

Pag. 241

- **Produzione speciale / Special production**
- **Prezzo da concordare / Price to be agreed upon**
- **Tempo di produzione 8 settimane / Lead time: 8 weeks**

Quantità minima / Minimum order quantity

▲ 150 sets ■ 300 sets ● 500 sets \* Non più ordinabile / No longer available



**H 325 \***  
 Serie A Novantacinque  
 design Gae Aulenti

Pag. 242



**H 324 △**  
 Serie AC Novantacinque  
 design Antonio Citterio

Pag. 242



**H 323 ○**  
 Serie B2 Novantaquattro  
 design Cini Boeri

Pag. 243



**H 322 \***  
 Serie B Novantaquattro  
 design Cini Boeri

Pag. 243



**H 321 △**  
 Serie AC Novantatre  
 design Antonio Citterio

Pag. 244



**H 320 △**  
 Serie AR Novantadue  
 design Aldo Rossi

Pag. 244



**H 319 □**  
 Serie VM Novantadue  
 design Vico Magistretti

Pag. 245



**H 318 □**  
 Serie AM Novantadue  
 design Angelo Mangiarotti

Pag. 245



**H 316 △**  
 Serie S Novantuno  
 design Ettore Sottsass

Pag. 246



**H 314 ○**  
 Serie S Novanta  
 design Ettore Sottsass

Pag. 246



**H 313 \***  
 Serie Otto F  
 design Franco Frattini

Pag. 247



**H 312 □**  
 Serie Sette B  
 design Cini Boeri

Pag. 247



**H 39 ○**  
 Serie Quattro M  
 design Vico Magistretti

Pag. 248



**H 38 □**  
 Serie Quattro S  
 design Ettore Sottsass

Pag. 248



**H 35 ○**  
 Serie Due G  
 design Gregotti Associati

Pag. 249



**H 34 \***  
 Serie Due Z  
 design Marco Zanuso

Pag. 249



**H 33 □**  
 Serie Otto G  
 design Gregotti Associati

Pag. 250



**H 32 ○**  
 Serie Otto B  
 design Cini Boeri

Pag. 250



**H 31 ○**  
 Serie Otto A  
 design Gae Aulenti

Pag. 251

**Materiale Ottone / Acciaio Inox AISI 316 L**  
Material Brass / Stainless Steel AISI 316 L

**Finiture / Finishes**  
**Cromo/Neropaco / Chrome/matt black**

**Maniglia per porta**  
Door handle

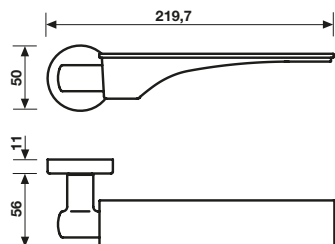

**H 371**  
Serie **LK Duemilaundici**  
design Leon Krier

**Materiale Ottone**  
Material Brass

**Finiture / Finishes**  
**Cromosat / Satin chrome**  
**Cromo / Chrome**

**Maniglia per porta**  
Door handle

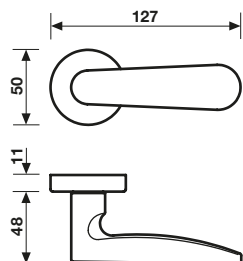

## H 360

Serie **FN Duemilasette**  
design Fabio Novembre

**Maniglia per porta**  
Door handle

**Materiale Ottone**  
Material Brass

**Finiture / Finishes**  
**Cromosat / Satin chrome**

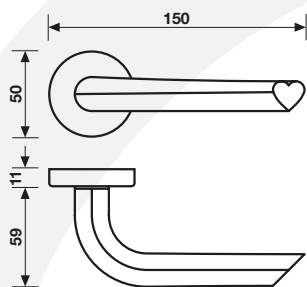

## H 353

Serie **AC3 Duemilaquattro**  
design Antonio Cittero con Toan Nguyen

**Maniglia per porta**  
Door handle

**Materiale Nikrall Lega Zama UNI 3717**  
Material Nikrall Lega Zama UNI 3717

**Finiture / Finishes**  
**Cromosat / Satin chrome**  
**Cromo / Chrome**

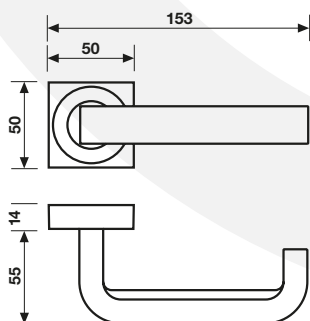

## H 351

Serie **AR Duemiladue**  
design Alan Ritchie-Philip Johnson Architects

**Materiale Ottone**  
Material Brass

**Finiture / Finishes**  
**Cromo / Chrome**

**Maniglia per porta**  
Door handle

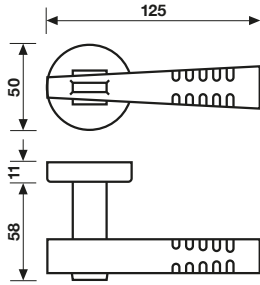

## H 349

Serie **CWL Duemiladue**  
design Chi Wing Lo

**Materiale Ottone**  
Material Brass

**Finiture / Finishes**  
**Cromosat / Satin chrome**

**Maniglia per porta**  
Door handle

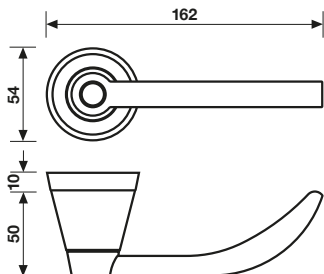

## H 347

Serie **MDF Duemiladue**  
design Massimiliano e Doriana Fuksas

**Maniglia per porta**  
Door handle

**Materiale Ottone e plexiglass**  
Material Brass and plexiglass

**Finiture / Finishes**  
**Cromosat / Satin chrome**

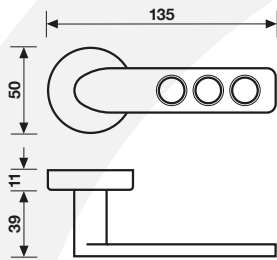

## H 345

Serie **LK Duemilauno**  
design Leon Krier

**Maniglia per porta**  
Door handle

**Materiale Ottone**  
Material Brass

**Finiture / Finishes**  
**Cromosat / Satin chrome**

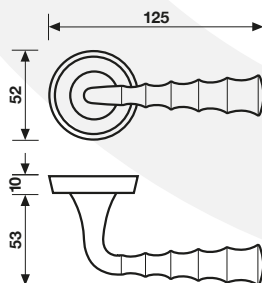

**Materiale Ottone**  
Material Brass

**Finiture / Finishes**  
**Cromo/Cromosat / Chrome/Satin chrome**

**Maniglia per porta**  
Door handle

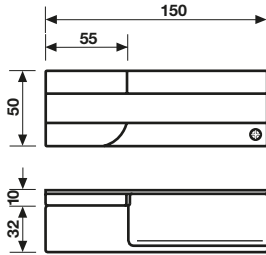

**Materiale Ottone**  
Material Brass

**Finiture / Finishes**  
**Cromo/Cromosat / Chrome/Satin chrome**

**H 342**  
Serie **RA Duemila**  
design Ron Arad

---

**Maniglia per porta**  
Door handle

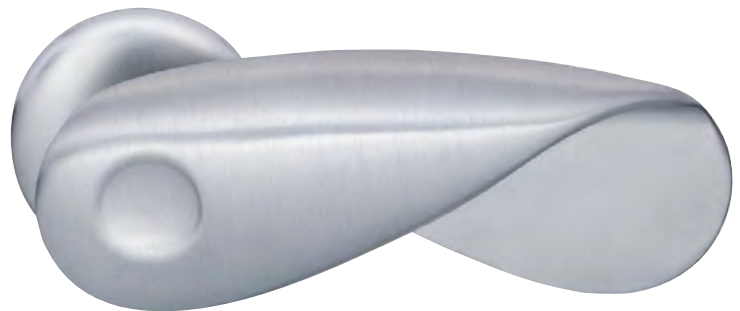
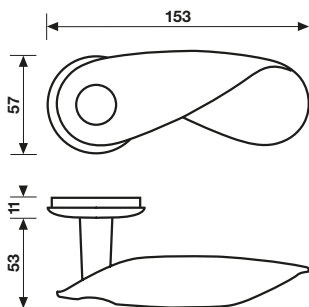

## H 340

Serie **HK Duemila**  
design Hans Kollhoff

**Materiale Ottone / Acciaio inox Aisi 316L**  
Material Brass / Stainless steel Aisi 316L

**Maniglia per porta**  
Door handle

**Finiture / Finishes**  
**Cromo/Inox satinato / Chrome/Satin chrome**

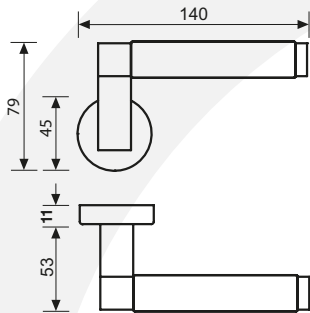

## H 339

Serie **AP Duemila**  
design Andrée Putman

**Maniglia per porta**  
Door handle

**Materiale Ottone**  
Material Brass

**Finiture / Finishes**  
Nikmatt

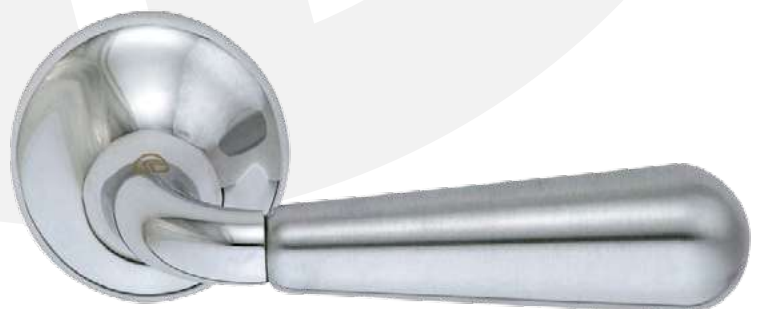
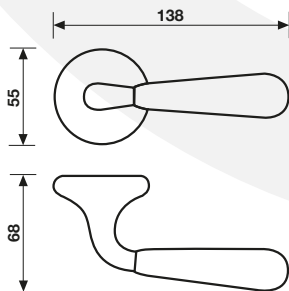



**Materiale Ottone**  
Material Brass

**Finiture / Finishes**  
**Cromosat\_Cromo** / Satin chrome\_Chrome  
**Orsatin\_Oro** / Satin brass\_Brass

**H 337**  
Serie **GP Novantotto**  
design Gustav Peichl

**Maniglia per porta**  
Door handle

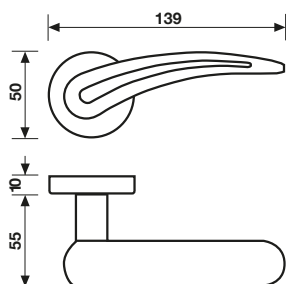

**Materiale Ottone**  
Material Brass

**Finiture / Finishes**  
**Nikmatt**

**H 333**  
Serie **P Novantotto**  
design Piano design Workshop

**Maniglia per porta**  
Door handle

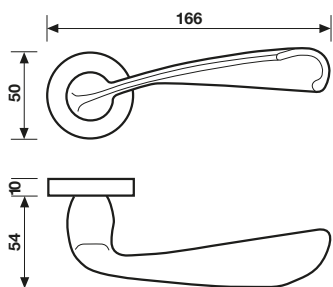

## H 331

Serie **MG Novantotto**  
design Micael Graves

**Maniglia per porta**  
Door handle

**Materiale Ottone**  
Material Brass

**Finiture / Finishes**  
**Cromosat /** Satin chrome  
**Orolucido /** Polished Brass

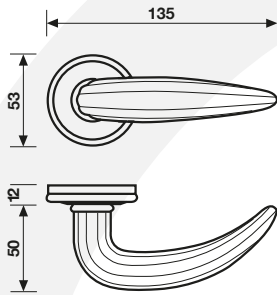

## H 328

Serie **NF Novantacinque**  
design Norman Foster

**Maniglia per porta**  
Door handle

**Materiale Ottone**  
Material Brass

**Finiture / Finishes**  
**Nikmatt /** Nikmatt

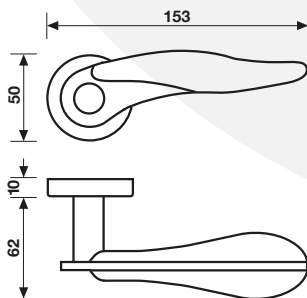

## H 325

Serie **A Novantacinque**  
design Gae Aulenti

**Materiale Ottone e porcellana**  
Material Brass and porcelaine

**Finiture / Finishes**  
**Cromo / Chrome**

**Maniglia per porta**  
Door handle

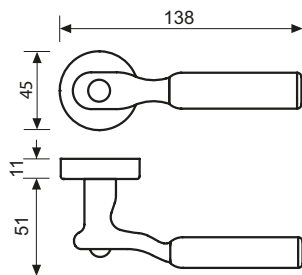

## H 324

Serie **AC Novantacinque**  
design Antonio Citterio

**Materiale Ottone**  
Material Brass

**Finiture / Finishes**  
**Cromo / Chrome**  
**Nikmatt / Nikmatt**

**Maniglia per porta**  
Door handle

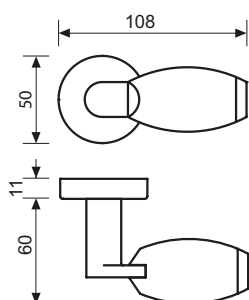

## H 323

Serie **B2 Novantaquattro**  
design Cini Boeri

**Maniglia per porta**  
Door handle

**Materiale Ottone / Plexiglass**  
Material Brass / Plexiglass

**Finiture / Finishes**  
**Nikmatt blu / Nikmatt blue**

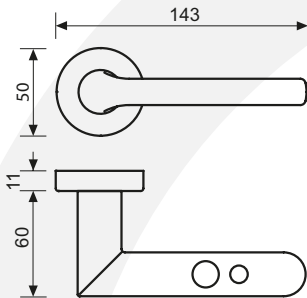

## H 322

Serie **B Novantaquattro**  
design Cini Boeri

**Maniglia per porta**  
Door handle

**Materiale Ottone / Plexiglass**  
Material Brass / Plexiglass

**Finiture / Finishes**  
**Cromo e acquamarina**  
Chrome and aquamarine

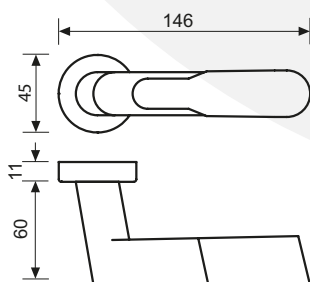

**Materiale Ottone**  
Material Brass

**Finiture / Finishes**  
**Cromo\_Nikmatt** / Chrome\_Nikmatt

**Maniglia per porta**  
Door handle

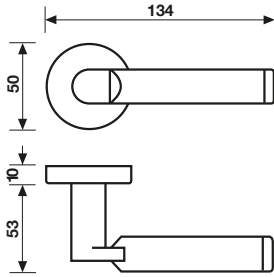

**Materiale Ottone**  
Material Brass

**Finiture / Finishes**  
**Orolucido** / Polished Brass

**Maniglia per porta**  
Door handle

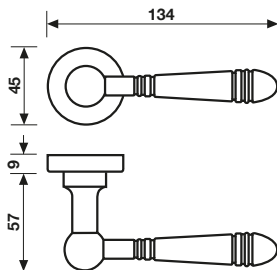

## H 319

Serie **VM Novantadue**  
design Vico Magistretti

**Maniglia per porta**  
Door handle

**Materiale Ottone**  
Material Brass

**Finiture / Finishes**  
**Nikmatt** / Nikmatt  
**Cromo** / Chrome  
**Orolucido** / Polished Brass

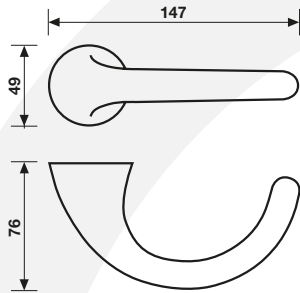

## H 318

Serie **AM Novantadue**  
design Angelo Mangiarotti

**Maniglia per porta**  
Door handle

**Materiale Ottone**  
Material Brass

**Finiture / Finishes**  
**Orolucido** / Polished Brass

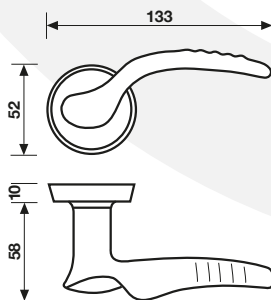

**Materiale Ottone**  
Material Brass

**Finiture / Finishes**  
**Cromo / Chrome**  
**Orolucido / Polished Brass**

**Maniglia per porta**  
Door handle

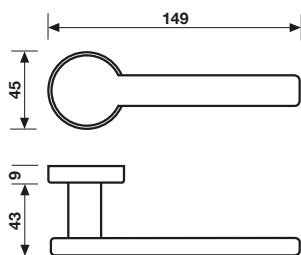

**Materiale Ottone**  
Material Brass

**Finiture / Finishes**  
**Cromo / Chrome**  
**Orolucido / Polished Brass**

**Maniglia per porta**  
Door handle

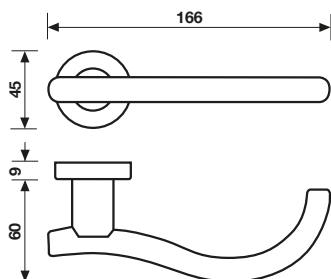

## H 313

Serie **Otto F**  
design Franco Frattini

**Maniglia per porta**  
Door handle

**Materiale Ottone / Radica**  
Material Brass / Wood

**Finiture / Finishes**  
**Cromo e radica** / Chrome and wood

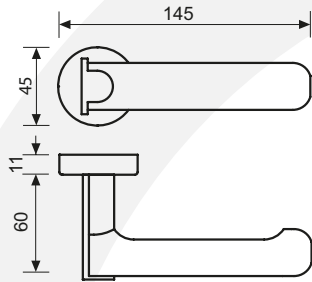

## H 312

Serie **Sette B**  
design Cini Boeri

**Maniglia per porta**  
Door handle

**Materiale Ottone**  
Material Brass

**Finiture / Finishes**  
**Orolucido** / Polished Brass

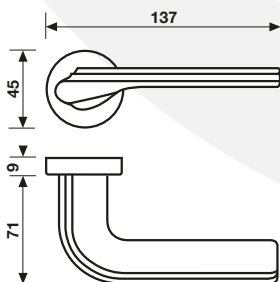



**Materiale Ottone**  
Material Brass

**Finiture / Finishes**  
**Orolucido / Polished Brass**

**Maniglia per porta**  
Door handle

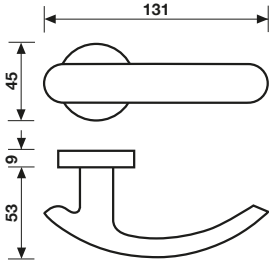

**Materiale Ottone**  
Material Brass

**Finiture / Finishes**  
**Orolucido / Polished Brass**

**Maniglia per porta**  
Door handle

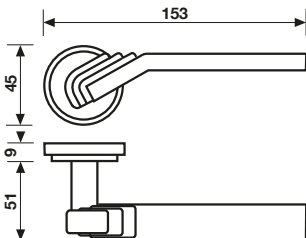

# H 35

Serie **Due G**  
design Gegotti Associati

**Maniglia per porta**  
Door handle

**Materiale Ottone**  
Material Brass

**Finiture / Finishes**  
**Orolucido / Polished Brass**  
**Cromo / Chrome**  
**Cromosat / Satin chrome**

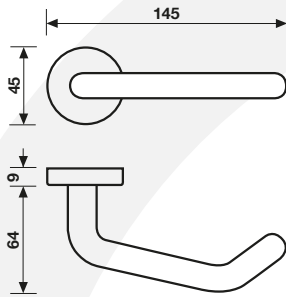

# H 34

Serie **Due Z**  
design Marco Zanuso

**Maniglia per porta**  
Door handle

**Materiale Ottone / Elastumero siliconico**  
Material Brass / Silicone elastomen

**Finiture / Finishes**  
**Cromo e cemento** / Chrome  
and cement

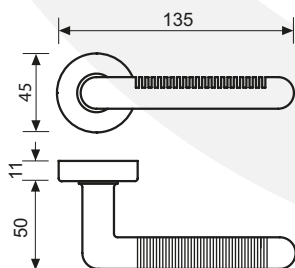

**Materiale Ottone**  
Material Brass

**Finiture / Finishes**  
**Orolucido / Polished Brass**  
**Cromo / Chrome**

**Maniglia per porta**  
Door handle

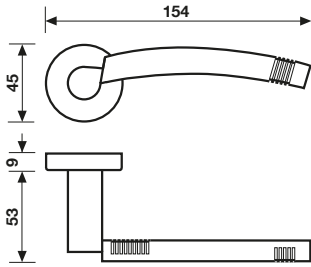

**Materiale Ottone**  
Material Brass

**Finiture / Finishes**  
**Orolucido / Polished Brass**

**Maniglia per porta**  
Door handle

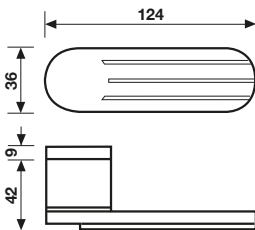

# H 31

Serie **Otto A**  
design Gae Aulenti

---

**Maniglia per porta**  
Door handle

**Materiale Ottone**  
Material Brass

**Finiture / Finishes**  
**Orolucido / Polished Brass**

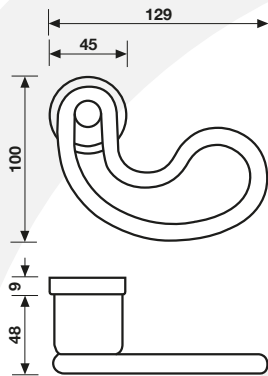





# **Fusital Inox**

## Composizione codice prodotto / Composition of product code

## Identificazione tipologia prodotto

Product type identification

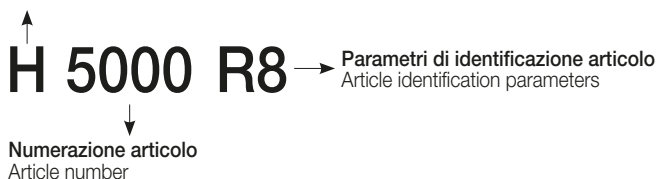

<b>H</b>	<b>Maniglie per porta e per finestra / Door handles and window handles</b>
<b>K</b>	<b>Pomoli per porta / Door knobs</b> <b>Maniglioni / Pull handles</b> <b>Bocchette / Escutcheons</b> <b>Chiusure privacy BZG / Bathroom privacy sets</b>
<b>M</b>	<b>Chiavi per porta / Door keys</b>
<b>E</b>	<b>Portabiti / Coat-hooks</b> <b>Ganci / Hooks</b>
<b>X</b>	<b>Complementari e sistemi di fissaggio</b> Complementary accessories and fixing systems

## Descrizione parametri di identificazione articolo / Description of article identification parameters

<b>...R..</b>		<b>Articolo con rosetta, molla di ritorno e sottorosetta con viti a legno, quadro 7 o 8 mm, bocchetta con foro chiave normale.</b> Article on rosette, with spring and anchor rose with wood screws, 7 or 8 mm spindle, with standard escutcheon
<b>...R .. Y</b>		<b>Articolo con rosetta, molla di ritorno, sottorosetta con viti a legno, quadro 7 o 8 mm, bocchetta con foro chiave cilindro.</b> Article on rosette, with spring and anchor rose with wood screws, 7 or 8 mm spindle, with cylinder escutcheon
<b>...R08..</b>		<b>Articolo con rosetta stretta, molla di ritorno e sottorosetta con viti a legno, quadro 8 mm, bocchetta stretta con foro chiave normale</b> Article on narrow rose, with return spring, anchor rose with wooden screw, 8 mm spindle narrow escutcheon with normal key hole
<b>...R08 .. Y</b>		<b>Articolo con rosetta stretta, molla di ritorno e sottorosetta con viti a legno, quadro 8 mm, bocchetta stretta con foro chiave cilindro</b> Article on narrow rose, with return spring, anchor rose with wooden screw, 8 mm spindle narrow escutcheon with cylinder key hole
<b>...RG..</b>		<b>Articolo con rosetta, molla di ritorno, sottorosetta con perni per viti passanti, quadro 8 o 8.5 mm, bocchetta con foro chiave normale</b> Article on rosette, with spring, anchor rose for bolt through fixing, 8 or 8.5 mm spindle, with standard escutcheon
<b>...RG .. Y</b>		<b>Articolo con rosetta, molla di ritorno, sottorosetta con perni per viti passanti, quadro 8 o 8,5 mm, bocchetta con foro chiave cilindro</b> Article on rosette, with spring, anchor rose for bolt through fixing, 8 or 8,5 mm spindle, with cylinder escutcheon.

## Legenda codici di identificazione articoli / Article identification codes

...P .. 70\*



Articolo con placca, quadro 7-8-8.5 mm, foro chiave normale. Il numero 70, indicato a titolo di esempio, che è variabile e dipende dalle normative di ogni mercato, indica l'interasse in mm tra foro chiave e foro maniglia.

Article on plate, 7-8-8,5 mm spindle, standard keyhole. The number "70" shown is variable and depends on the requirements of each individual market. It indicates distance between the spindle and keyhole centre in mm.

...P .. Y 85\*



Articolo con placca, quadro 7-8-8.5 mm, foro chiave cilindro. Il numero 85, indicato a titolo di esempio, che è variabile e dipende dalle normative di ogni mercato, indica l'interasse in mm tra foro chiave e foro maniglia.

Article on plate, 7-8-8,5 mm spindle, cylinder keyhole. The number "85" shown is variable and depends on the requirements of each individual market. It indicates distance between the spindle and keyhole centre in mm.

...F



Maniglia per finestra

Window handle

Fenstergriff

Poignée de fenêtre

...F RS



Maniglia per finestra con movimento DRY-KEEP 4 e/o 8 scatti, disponibile con lunghezza quadro 27-30-35-41-45-50 mm

Window handle with DRY-KEEP movement, 4/8 click positions, available with spindle lengths 27-30-35-41-45-50 mm

...R 6-7-8  
BZG

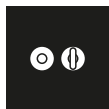

Chiusura privacy, quadro disponibile 6-7-8 mm e lunghezza 75-85 mm, sottorosea con viti a legno

Bathroom privacy set, 6-7-8 mm diameter spindle with length of 75-85 mm. Anchor rose with wood screws

...RG 6-7-8  
BZG

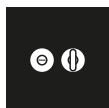

Chiusura privacy, quadro disponibile 6-7-8 mm e lunghezza 75-85 mm, sottorosea con viti passanti

Bathroom privacy set, 6-7-8 mm diameter spindle with length of 75-85 mm. Anchor rose with through screws

...RS 6-7-8  
BZG



Chiusura privacy, quadro disponibile 6-7-8 mm e lunghezza 75-85 mm, sottorosea con viti a legno, con indicatore libero/occupato

Bathroom privacy set, 6-7-8 mm diameter spindle with length of 75-85 mm. Anchor rose with wood screws. Vacant/engaged indicator

...RSG 6-7-8  
BZG



Chiusura privacy, quadro disponibile 6-7-8 mm e lunghezza 75-85 mm, sottorosea con viti passanti, con indicatore libero/occupato

Bathroom privacy set, 6-7-8 mm diameter spindle with length of 75-85 mm. Anchor rose with through screws. Vacant/engaged indicator

...GL



Maniglia per serratura porte vetro

Door handle suitable for glass door locks

Per le versioni disponibili fare riferimento al listino-prezzi in vigore nel paese di appartenenza

To see the available versions, please refer to the price-list in force in each Country





**Maniglia per porta**  
Door handle

**Materiale Acciaio Inox AISI 316 L**  
Material Stainless Steel AISI 316 L

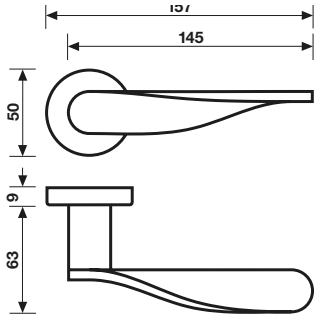

**Finiture**

Finishes



**H 5022 FRS-41**

**Maniglia per finestra**  
Window handle

**Movimento**  
**4 scatti**  
Movement  
4 click positions

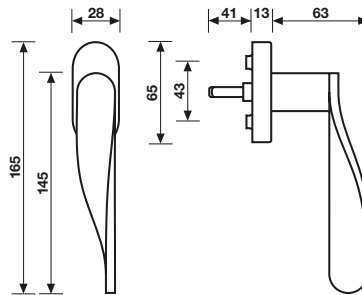

**H 5022 R8**

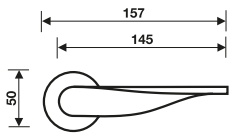

**H 5022 RC9 AS**  
**H 5022 RC8**  
**H 5022 RC8,5**

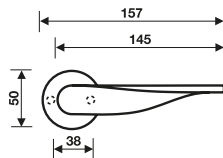

**H 5022 RO9 AS**  
**H 5022 RO8 AS**

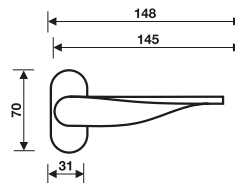

**H 5022 RP Passage**

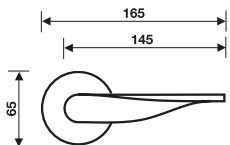

**H 5022 RP Privacy**

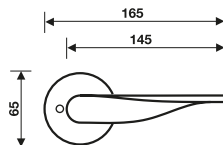

# H 5022

Serie **Einser**  
design Jan Kleihues

## R 5154

**Bocchetta**  
Escutcheon



**Materiale Acciaio Inox AISI 316 L**  
Material Stainless Steel AISI 316 L

**Finiture / Finishes**  
Satinato  
Lucido

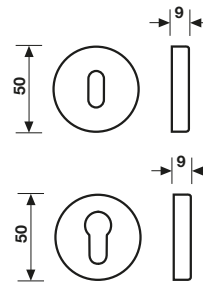

**R 5154 RN**  
Foro chiave normale  
Standard hole  
escutcheon

**R 5154 RY**  
Foro chiave cilindro  
Euro-profile hole  
escutcheon

## R 5154 RG

**Bocchetta stretta per RG8**  
Narrow Escutcheon for RG8



**Materiale Acciaio Inox AISI 316 L**  
Material Stainless Steel AISI 316 L

**Finiture / Finishes**  
Satinato  
Lucido

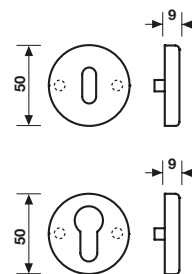

**R 5154 RGN**  
Foro chiave normale  
Standard hole  
escutcheon

**R 5154 RGY**  
Foro chiave cilindro  
Euro-profile hole  
escutcheon

## R 5155

**Bocchetta stretta**  
Narrow Escutcheon



**Materiale Acciaio Inox AISI 316 L**  
Material Stainless Steel AISI 316 L

**Finiture / Finishes**  
Satinato  
Lucido

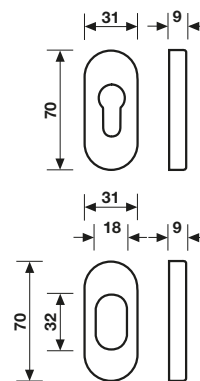

**R 5155 Y OV**  
Foro chiave normale  
Standard hole  
escutcheon

**R 5155 CO OV**  
Foro chiave cilindro  
Euro-profile hole  
escutcheon

## R 5145

**Bocchetta stretta**  
Narrow Escutcheon



**Materiale Acciaio Inox AISI 316 L**  
Material Stainless Steel AISI 316 L

**Finiture / Finishes**  
Satinato  
Lucido

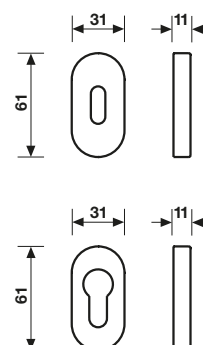

**R 5145 N**  
Foro chiave normale  
Standard hole  
escutcheon

**R 5145 Y**  
Foro chiave cilindro  
Euro-profile hole  
escutcheon



**Maniglia per porta**  
Door handle

**Materiale Acciaio Inox AISI 316 L**  
Material Stainless Steel AISI 316 L

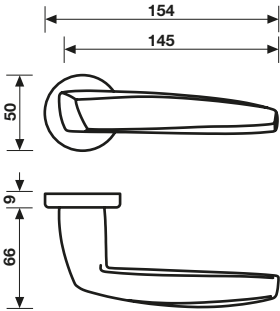

**Finiture**

Finishes

 Satinato

 Lucido

**H 5021 FRS-41**

**Maniglia per finestra**  
Window handle

**Movimento**  
**4 scatti**  
Movement  
4 click positions

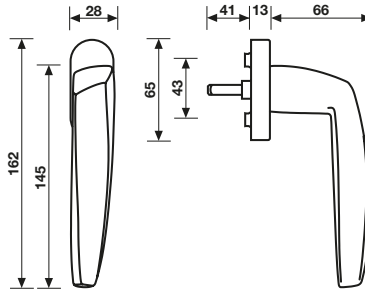

**H 5021 R8**

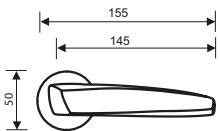

**H 5021 RG9 AS**  
**H 5021 RG8**  
**H 5021 RG8,5**

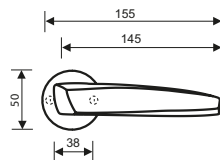

**H 5021 RO9 AS**  
**H 5021 RO8 AS**

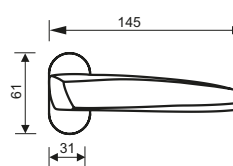

**H 5021 RP Passage**

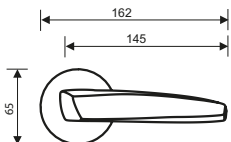

**H 5021 RP Privacy**

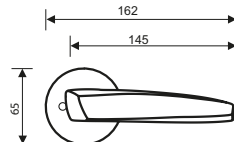

# H 5021

Serie **Arrowhead**  
design Frank O. Gehry

## R 5154

**Bocchetta**  
Escutcheon



**Materiale Acciaio Inox AISI 316 L**  
Material Stainless Steel AISI 316 L

**Finiture / Finishes**  
Satinato  
Lucido

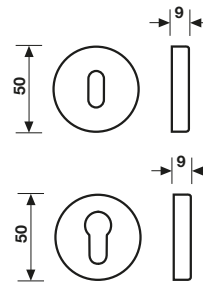

**R 5154 RN**  
Foro chiave normale  
Standard hole  
escutcheon

**R 5154 RY**  
Foro chiave cilindro  
Euro-profile hole  
escutcheon

## R 5154 RG

**Bocchetta stretta per RG8**  
Narrow Escutcheon for RG8



**Materiale Acciaio Inox AISI 316 L**  
Material Stainless Steel AISI 316 L

**Finiture / Finishes**  
Satinato  
Lucido

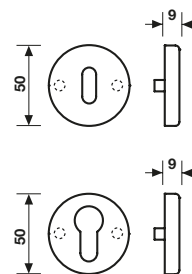

**R 5154 RGN**  
Foro chiave normale  
Standard hole  
escutcheon

**R 5154 RGY**  
Foro chiave cilindro  
Euro-profile hole  
escutcheon

## R 5155

**Bocchetta stretta**  
Narrow Escutcheon



**Materiale Acciaio Inox AISI 316 L**  
Material Stainless Steel AISI 316 L

**Finiture / Finishes**  
Satinato  
Lucido

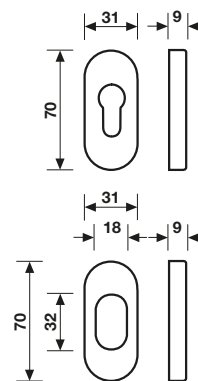

**R 5155 Y OV**  
Foro chiave normale  
Standard hole  
escutcheon

**R 5155 CO OV**  
Foro chiave cilindro  
Euro-profile hole  
escutcheon

## R 5145

**Bocchetta stretta**  
Narrow Escutcheon



**Materiale Acciaio Inox AISI 316 L**  
Material Stainless Steel AISI 316 L

**Finiture / Finishes**  
Satinato  
Lucido

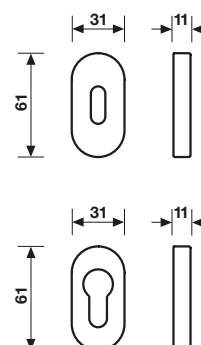

**R 5145 N**  
Foro chiave normale  
Standard hole  
escutcheon

**R 5145 Y**  
Foro chiave cilindro  
Euro-profile hole  
escutcheon

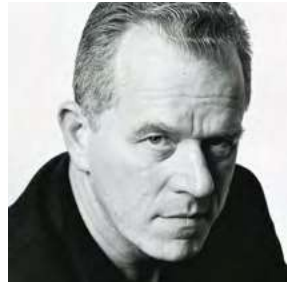

**Maniglia per porta**  
Door handle

**Materiale Acciaio Inox AISI 316 L**  
Material Stainless Steel AISI 316 L

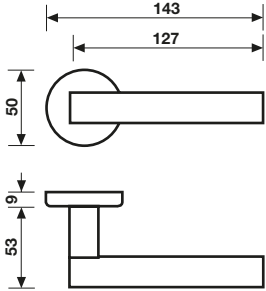

**Finiture**  
Finishes

-  Satinato
-  Lucido

**H 5017 FRS-41**

**Maniglia per finestra**  
Window handle

**Movimento**  
**4 scatti**  
Movement  
4 click positions

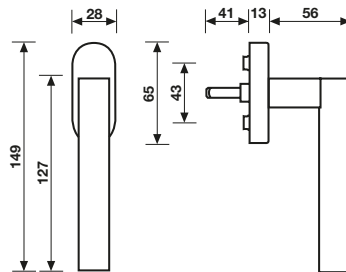

**H 5017 R8**

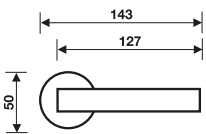

**H 5017 RG9 AS**  
**H 5017 RG8**  
**H 5017 RG8,5**

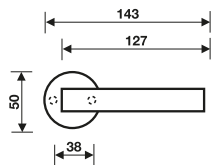

**H 5017 R09 AS**  
**H 5017 R08 AS**

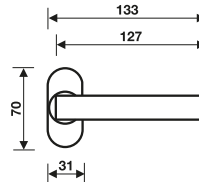

**H 5017 RP Passage**

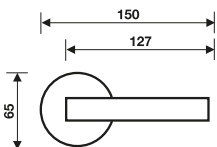

**H 5017 RP Privacy**

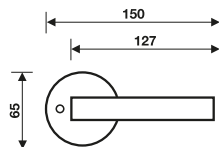

# H 5017

Serie **Gottardo**  
design Hans Kollhoff

## R 5154

**Bocchetta**  
Escutcheon



**Materiale Acciaio Inox AISI 316 L**  
Material Stainless Steel AISI 316 L

**Finiture / Finishes**  
Satinato  
Lucido

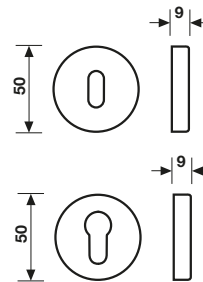

**R 5154 RN**  
Foro chiave normale  
Standard hole  
escutcheon

**R 5154 RY**  
Foro chiave cilindro  
Euro-profile hole  
escutcheon

## R 5154 RG

**Bocchetta stretta per RG8**  
Narrow Escutcheon for RG8



**Materiale Acciaio Inox AISI 316 L**  
Material Stainless Steel AISI 316 L

**Finiture / Finishes**  
Satinato  
Lucido

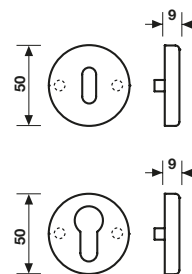

**R 5154 RGN**  
Foro chiave normale  
Standard hole  
escutcheon

**R 5154 RGY**  
Foro chiave cilindro  
Euro-profile hole  
escutcheon

## R 5155

**Bocchetta stretta**  
Narrow Escutcheon



**Materiale Acciaio Inox AISI 316 L**  
Material Stainless Steel AISI 316 L

**Finiture / Finishes**  
Satinato  
Lucido

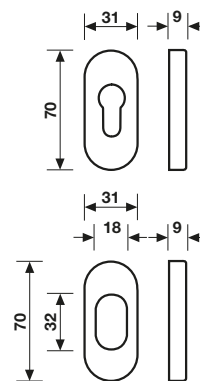

**R 5155 Y OV**  
Foro chiave normale  
Standard hole  
escutcheon

**R 5155 CO OV**  
Foro chiave cilindro  
Euro-profile hole  
escutcheon

## R 5145

**Bocchetta stretta**  
Narrow Escutcheon



**Materiale Acciaio Inox AISI 316 L**  
Material Stainless Steel AISI 316 L

**Finiture / Finishes**  
Satinato  
Lucido

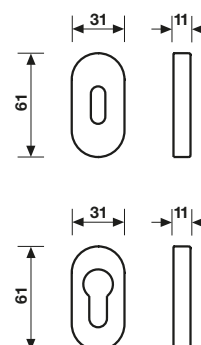

**R 5145 N**  
Foro chiave normale  
Standard hole  
escutcheon

**R 5145 Y**  
Foro chiave cilindro  
Euro-profile hole  
escutcheon



**Maniglia per porta**  
Door handle

**Materiale Acciaio Inox AISI 316 L**  
Material Stainless Steel AISI 316 L

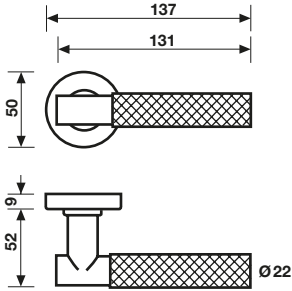

**Finiture**

Finishes

 Satinato

 Lucido

**H 5015 FRS-41**

**Maniglia per finestra**  
Window handle

**Movimento**  
**4 scatti**  
Movement  
4 click positions

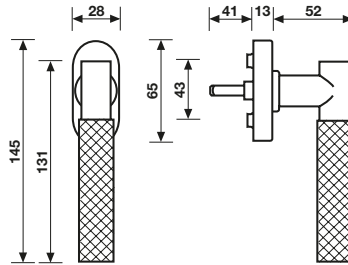

**H 5015 R8**

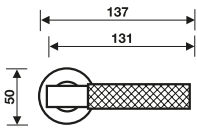

**H 5015 RG9 AS**  
**H 5015 RG8**  
**H 5015 RG8,5**

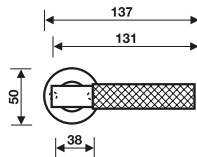

**H 5015 R09 AS**  
**H 5015 R08 AS**

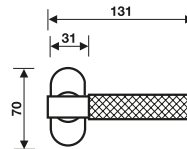

**H 5015 RP Passage**

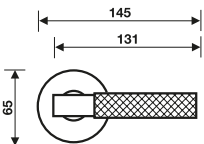

**H 5015 RP Privacy**

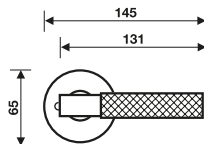

# H 5015

Serie **K2**

design Antonio Citterio

## P 5408 25

**Maniglione**

Pull Handle

**Materiale Acciaio Inox AISI 316 L**

Material Stainless Steel AISI 316 L

**Finiture / Finishes**

Satinato

Lucido

**Interasse / Centre distance**

300 mm

**NB: maniglione con o senza rosetta.**

**Interasse personalizzabile fino a 800 mm.**

**Quantità e prezzi da richiedere**

Pull handle with or without rosette.

Centre distance possible on request till 800 mm.

Quantity and prices to be agreed upon

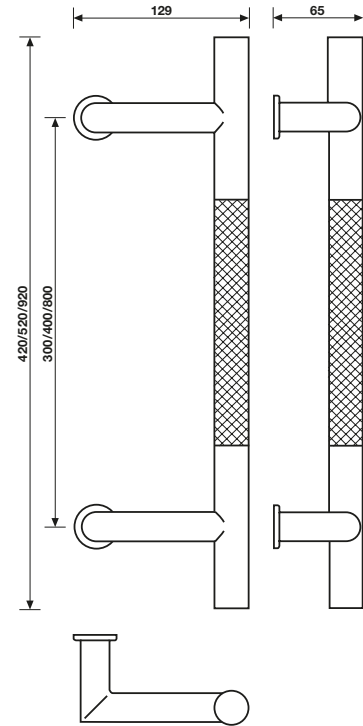

## P 5406 25

**Maniglione**

Pull Handle

**Materiale Acciaio Inox AISI 316 L**

Material Stainless Steel AISI 316 L

**Finiture / Finishes**

Satinato

Lucido

**Interasse / Centre distance**

300 mm

**NB: maniglione con o senza rosetta.**

**Interasse personalizzabile fino a 800 mm.**

**Quantità e prezzi da richiedere**

Pull handle with or without rosette.

Centre distance possible on request till 800 mm.

Quantity and prices to be agreed upon

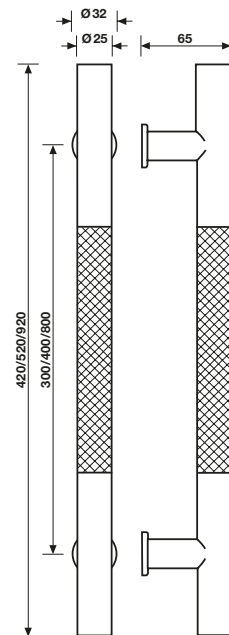



## R 5154

**Bocchetta**  
Escutcheon



**Materiale Acciaio Inox AISI 316 L**  
Material Stainless Steel AISI 316 L

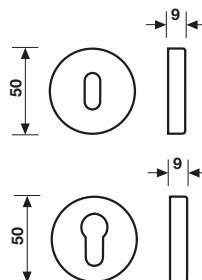

**Finiture / Finishes**  
Satinato  
Lucido

**R 5154 RN**  
Foro chiave normale  
Standard hole  
escutcheon

**R 5154 RY**  
Foro chiave cilindro  
Euro-profile hole  
escutcheon

## R 5154 RG

**Bocchetta stretta per RG8**  
Narrow Escutcheon for RG8



**Materiale Acciaio Inox AISI 316 L**  
Material Stainless Steel AISI 316 L

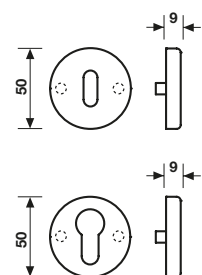

**Finiture / Finishes**  
Satinato  
Lucido

**R 5154 RGN**  
Foro chiave normale  
Standard hole  
escutcheon

**R 5154 RGY**  
Foro chiave cilindro  
Euro-profile hole  
escutcheon

## R 5155

**Bocchetta stretta**  
Narrow Escutcheon



**Materiale Acciaio Inox AISI 316 L**  
Material Stainless Steel AISI 316 L

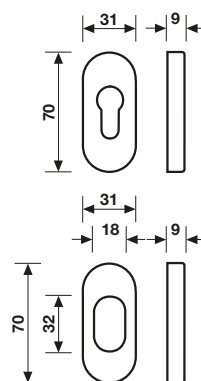

**Finiture / Finishes**  
Satinato  
Lucido

**R 5155 Y OV**  
Foro chiave normale  
Standard hole  
escutcheon

**R 5155 CO OV**  
Foro chiave cilindro  
Euro-profile hole  
escutcheon

## R 5145

**Bocchetta stretta**  
Narrow Escutcheon



**Materiale Acciaio Inox AISI 316 L**  
Material Stainless Steel AISI 316 L

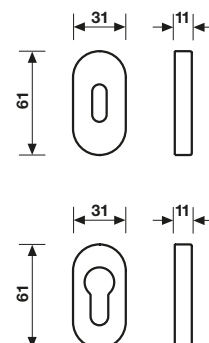

**Finiture / Finishes**  
Satinato  
Lucido

**R 5145 N**  
Foro chiave normale  
Standard hole  
escutcheon

**R 5145 Y**  
Foro chiave cilindro  
Euro-profile hole  
escutcheon

# H 5014

Serie **Bernina**  
design Fusital Workshop

**Maniglia per porta**  
Door handle

**Materiale Acciaio Inox AISI 316 L**  
Material Stainless Steel AISI 316 L

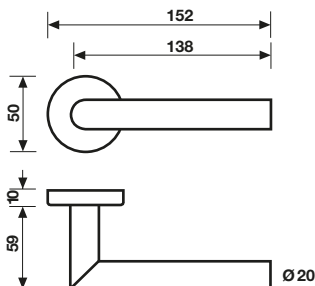

## Finiture

Finishes



Satinato



Lucido

## H 5014 FRS-41

**Maniglia per finestra**  
Window handle

**Movimento**  
**4 scatti**  
Movement  
4 click positions

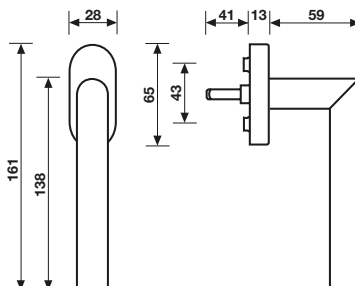

### H 5014 R8

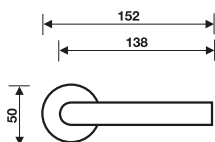

### H 5014 RG9 AS H 5014 RG8 H 5014 RG8,5

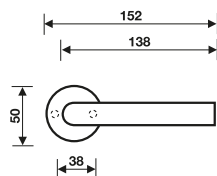

### H 5014 R09 AS H 5014 R08 AS

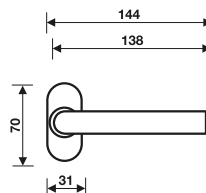

### H 5014 RP Passage

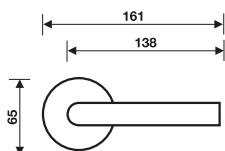

### H 5014 RP Privacy

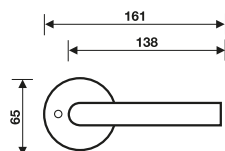

## R 5154

**Bocchetta**  
Escutcheon



**Materiale Acciaio Inox AISI 316 L**  
Material Stainless Steel AISI 316 L

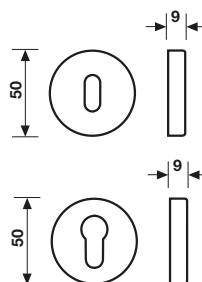

**Finiture / Finishes**  
Satinato  
Lucido

**R 5154 RN**  
Foro chiave normale  
Standard hole  
escutcheon

**R 5154 RY**  
Foro chiave cilindro  
Euro-profile hole  
escutcheon

## R 5154 RG

**Bocchetta stretta per RG8**  
Narrow Escutcheon for RG8



**Materiale Acciaio Inox AISI 316 L**  
Material Stainless Steel AISI 316 L

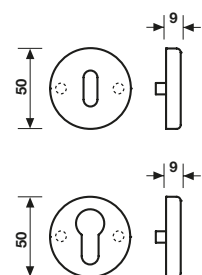

**Finiture / Finishes**  
Satinato  
Lucido

**R 5154 RGN**  
Foro chiave normale  
Standard hole  
escutcheon

**R 5154 RGY**  
Foro chiave cilindro  
Euro-profile hole  
escutcheon

## R 5155

**Bocchetta stretta**  
Narrow Escutcheon



**Materiale Acciaio Inox AISI 316 L**  
Material Stainless Steel AISI 316 L

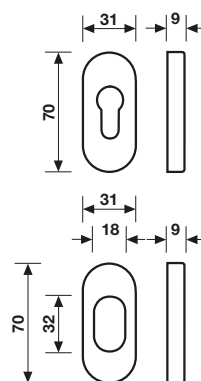

**Finiture / Finishes**  
Satinato  
Lucido

**R 5155 Y OV**  
Foro chiave normale  
Standard hole  
escutcheon

**R 5155 CO OV**  
Foro chiave cilindro  
Euro-profile hole  
escutcheon

## R 5145

**Bocchetta stretta**  
Narrow Escutcheon



**Materiale Acciaio Inox AISI 316 L**  
Material Stainless Steel AISI 316 L

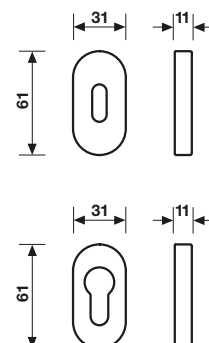

**Finiture / Finishes**  
Satinato  
Lucido

**R 5145 N**  
Foro chiave normale  
Standard hole  
escutcheon

**R 5145 Y**  
Foro chiave cilindro  
Euro-profile hole  
escutcheon



# H 5010

Serie **Cresta**  
design Foster and Partners

**Maniglia per porta**  
Door handle

**Materiale Acciaio Inox AISI 316 L**  
Material Stainless Steel AISI 316 L

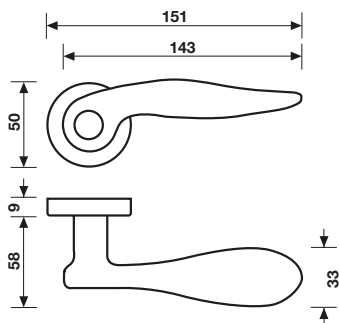

## Finiture

Finishes



Satinato



Lucido

## K 5304

**Pomolo per porta**  
Door knob

**Materiale Acciaio inox**  
Material Stainless steel

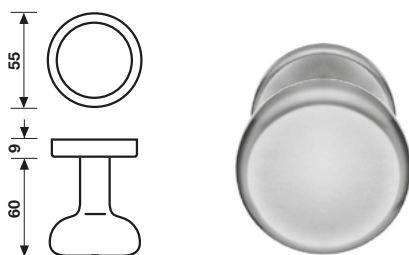

## H 5010 FRS-41

**Maniglia per finestra**  
Window handle

**Movimento**  
**4 scatti**  
Movement  
4 click positions

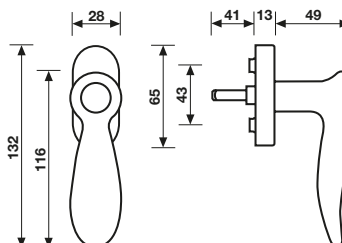

### H 5010 R8

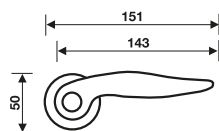

### H 5010 RG9 AS H 5010 RG8 H 5010 RG8,5

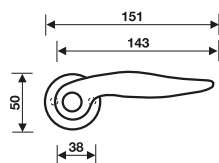

### H 5010 RO9 AS H 5010 RO8 AS

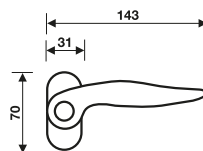

### H 5010 RP Passage

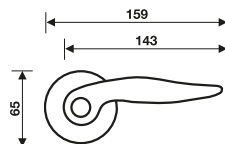

### H 5010 RP Privacy

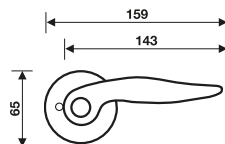

## R 5154

**Bocchetta**  
Escutcheon



**Materiale Acciaio Inox AISI 316 L**  
Material Stainless Steel AISI 316 L

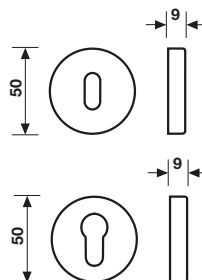

**Finiture / Finishes**  
Satinato  
Lucido

**R 5154 RN**  
Foro chiave normale  
Standard hole  
escutcheon

**R 5154 RY**  
Foro chiave cilindro  
Euro-profile hole  
escutcheon

## R 5154 RG

**Bocchetta stretta per RG8**  
Narrow Escutcheon for RG8



**Materiale Acciaio Inox AISI 316 L**  
Material Stainless Steel AISI 316 L

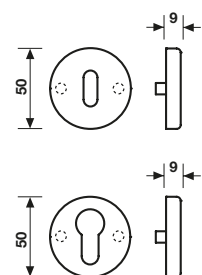

**Finiture / Finishes**  
Satinato  
Lucido

**R 5154 RGN**  
Foro chiave normale  
Standard hole  
escutcheon

**R 5154 RGY**  
Foro chiave cilindro  
Euro-profile hole  
escutcheon

## R 5155

**Bocchetta stretta**  
Narrow Escutcheon



**Materiale Acciaio Inox AISI 316 L**  
Material Stainless Steel AISI 316 L

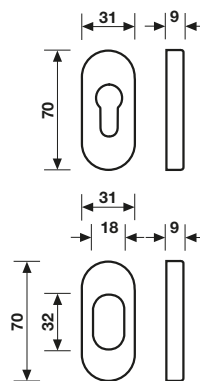

**Finiture / Finishes**  
Satinato  
Lucido

**R 5155 Y OV**  
Foro chiave normale  
Standard hole  
escutcheon

**R 5155 CO OV**  
Foro chiave cilindro  
Euro-profile hole  
escutcheon

## R 5145

**Bocchetta stretta**  
Narrow Escutcheon



**Materiale Acciaio Inox AISI 316 L**  
Material Stainless Steel AISI 316 L

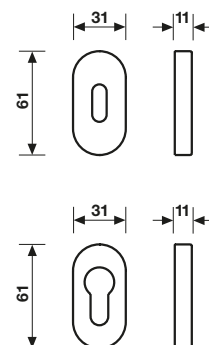

**Finiture / Finishes**  
Satinato  
Lucido

**R 5145 N**  
Foro chiave normale  
Standard hole  
escutcheon

**R 5145 Y**  
Foro chiave cilindro  
Euro-profile hole  
escutcheon

# H 5010

Serie **Cresta**  
design Foster and Partners

---

## S 5505 R

**Materiale Acciaio Inox AISI 316 L**  
Material Stainless Steel AISI 316 L

**Finiture / Finishes**  
Satinato  
Lucido

**Chiusura privacy BZG**  
Bathroom privacy set

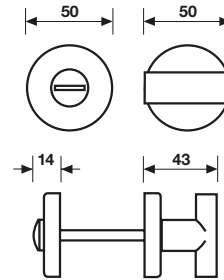

**S 5505 R6-7-8 BZG**



## S 5505 RS

**Materiale Acciaio Inox AISI 316 L**  
Material Stainless Steel AISI 316 L

**Finiture / Finishes**  
Satinato  
Lucido

**Chiusura privacy BZG**  
Bathroom privacy set

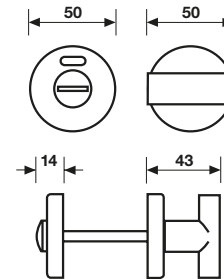

**S 5505 RS6-7-8 BZG**





**Maniglia per porta**  
Door handle

**Materiale Acciaio Inox AISI 316 L**  
Material Stainless Steel AISI 316 L

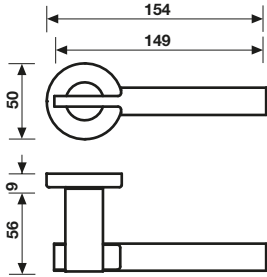

**Finiture**

Finishes



Satinato

**H 5008 FRS-41**

**Maniglia per finestra**  
Window handle

**Movimento**  
**4 scatti**  
Movement  
4 click positions

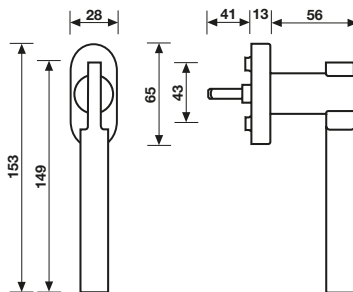

**H 5008 R8**

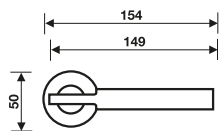

**H 5008 RG9 AS**  
**H 5008 RG8**  
**H 5008 RG8,5**

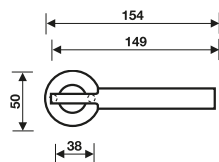

**H 5008 RO9 AS**  
**H 5008 RO8 AS**

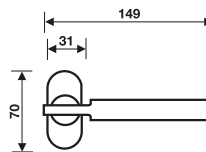

**H 5008 RP Passage**

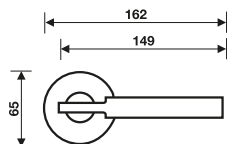

**H 5008 RP Privacy**

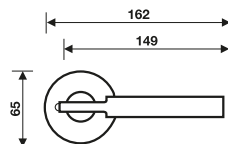

# H 5008

Serie **Himalaya**

design Taller Design Ricardo Bofill



## P 5405 25

**Maniglione**

Pull Handle

**Materiale Acciaio Inox AISI 316 L**

Material Stainless Steel AISI 316 L

**Finiture** Finishes

Satinato

**Interasse / Centre distance**

300 mm

**NB:** maniglione con o senza rosetta. Interasse personalizzabile fino a 800 mm.

Quantità e prezzi da richiedere

Pull handle with or without rosette. Centre distance possible on request till 800 mm.

Quantity and prices to be agreed upon

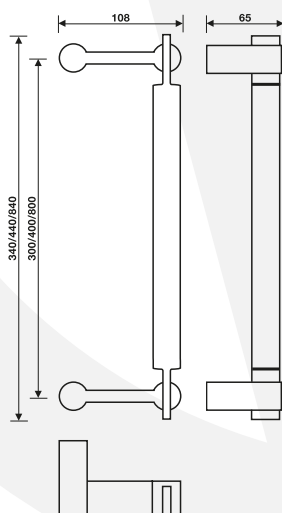
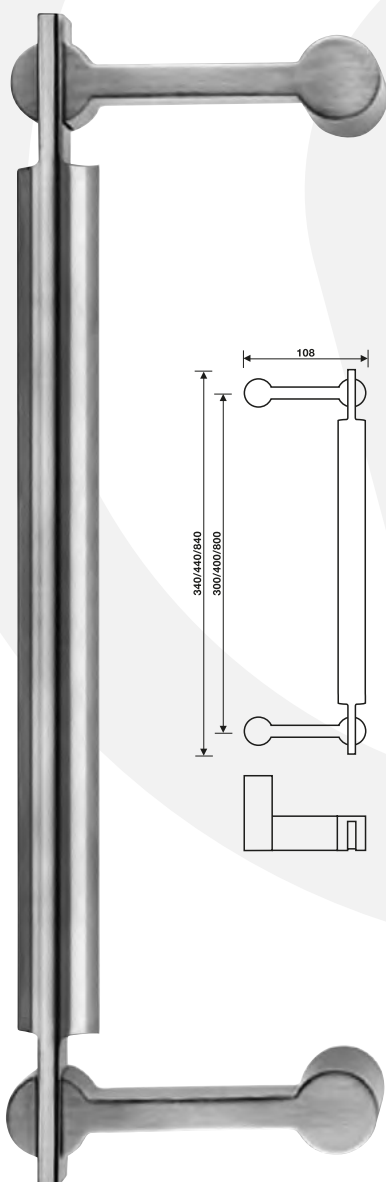
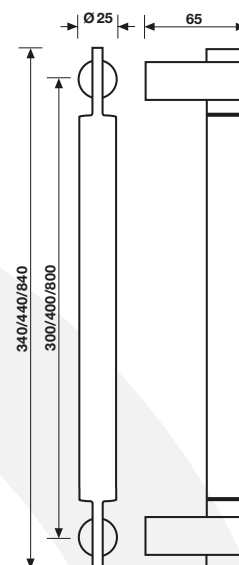

## P 5407

**Maniglione**

Pull Handle

**Materiale Acciaio Inox AISI 316 L**

Material Stainless Steel AISI 316 L

**Finiture** Finishes

Satinato

**Interasse / Centre distance**

300 mm

**NB:** maniglione con o senza rosetta.

Interasse personalizzabile fino a 800 mm.

Quantità e prezzi da richiedere

Pull handle with or without rosette.

Centre distance possible on request till 800 mm.

Quantity and prices to be agreed upon



**R 5154**

**Bocchetta**  
Escutcheon



**Materiale Acciaio Inox AISI 316 L**  
Material Stainless Steel AISI 316 L

**Finiture / Finishes**  
Satinato

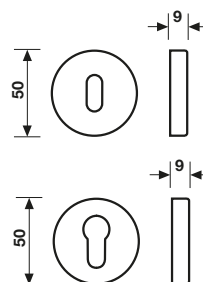

**R 5154 RN**  
Foro chiave normale  
Standard hole  
escutcheon

**R 5154 RY**  
Foro chiave cilindro  
Euro-profile hole  
escutcheon

**R 5154 RG**

**Bocchetta stretta per RG8**  
Narrow Escutcheon for RG8



**Materiale Acciaio Inox AISI 316 L**  
Material Stainless Steel AISI 316 L

**Finiture / Finishes**  
Satinato

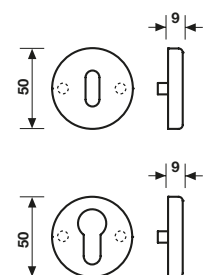

**R 5154 RGN**  
Foro chiave normale  
Standard hole  
escutcheon

**R 5154 RGY**  
Foro chiave cilindro  
Euro-profile hole  
escutcheon

**R 5155**

**Bocchetta stretta**  
Narrow Escutcheon



**Materiale Acciaio Inox AISI 316 L**  
Material Stainless Steel AISI 316 L

**Finiture / Finishes**  
Satinato

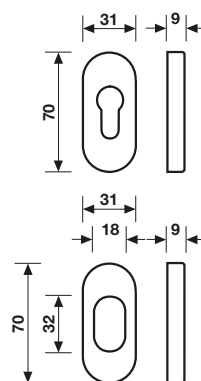

**R 5155 Y OV**  
Foro chiave normale  
Standard hole  
escutcheon

**R 5155 CO OV**  
Foro chiave cilindro  
Euro-profile hole  
escutcheon

**R 5145**

**Bocchetta stretta**  
Narrow Escutcheon



**Materiale Acciaio Inox AISI 316 L**  
Material Stainless Steel AISI 316 L

**Finiture / Finishes**  
Satinato

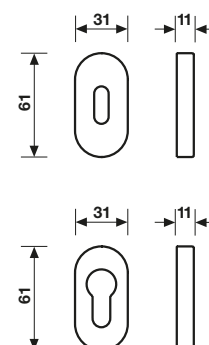

**R 5145 N**  
Foro chiave normale  
Standard hole  
escutcheon

**R 5145 Y**  
Foro chiave cilindro  
Euro-profile hole  
escutcheon

## S 5501 R

**Materiale Acciaio Inox AISI 316 L**  
Material Stainless Steel AISI 316 L

**Finiture / Finishes**  
Satinato

**Chiusura privacy BZG**  
Bathroom privacy set

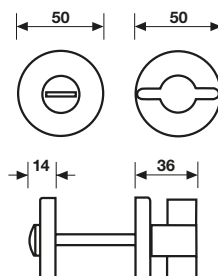

**S 5501 R6-7-8 BZG**



## S 5501 RS

**Materiale Acciaio Inox AISI 316 L**  
Material Stainless Steel AISI 316 L

**Finiture / Finishes**  
Satinato

**Chiusura privacy BZG**  
Bathroom privacy set

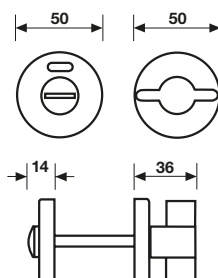

**S 5501 RS6-7-8 BZG**



## S 5501 RG

**Materiale Acciaio Inox AISI 316 L**  
Material Stainless Steel AISI 316 L

**Finiture / Finishes**  
Satinato

**Chiusura privacy BZG per RG8**  
Bathroom privacy set for RG8

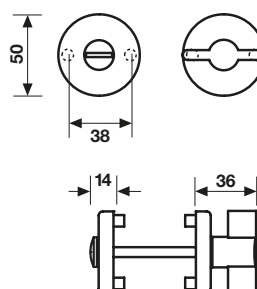

**S 5501 RG6-7-8 BZG**





**Maniglia per porta**  
Door handle

**Materiale Acciaio Inox AISI 316 L**  
Material Stainless Steel AISI 316 L

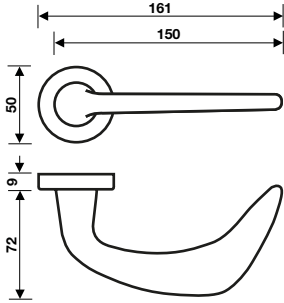

**Finiture**

Finishes

 Satinato

 Lucido

**H 5005 FRS-41**

**Maniglia per finestra**  
Window handle

**Movimento**  
**4 scatti**  
Movement  
4 click positions

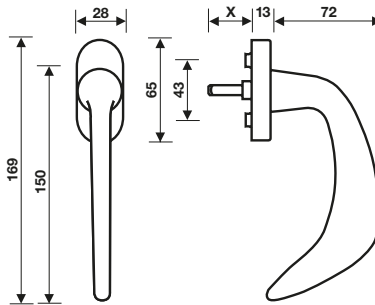

**H 5005 R8**

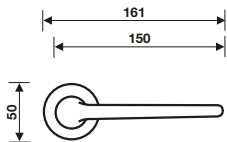

**H 5005 RG9 AS**  
**H 5005 RG8**  
**H 5005 RG8,5**

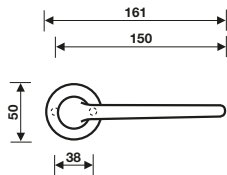

**H 5005 R09 AS**  
**H 5005 R08 AS**

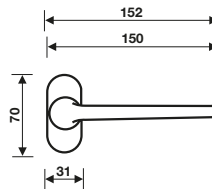

**H 5005 RP Passage**

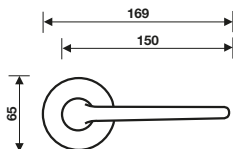

**H 5005 RP Privacy**

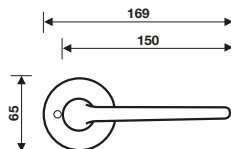

# H 5005

Serie **Amiata**  
design D'Urbino Lomazzi

## R 5154

**Bocchetta**  
Escutcheon



**Materiale Acciaio Inox AISI 316 L**  
Material Stainless Steel AISI 316 L

**Finiture / Finishes**  
Satinato  
Lucido

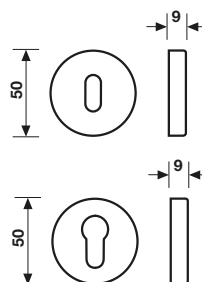

**R 5154 RN**  
Foro chiave normale  
Standard hole  
escutcheon

**R 5154 RY**  
Foro chiave cilindro  
Euro-profile hole  
escutcheon

## R 5154 RG

**Bocchetta stretta per RG8**  
Narrow Escutcheon for RG8



**Materiale Acciaio Inox AISI 316 L**  
Material Stainless Steel AISI 316 L

**Finiture / Finishes**  
Satinato  
Lucido

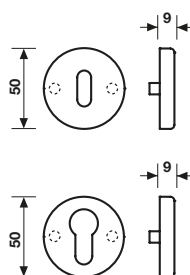

**R 5154 RGN**  
Foro chiave normale  
Standard hole  
escutcheon

**R 5154 RGY**  
Foro chiave cilindro  
Euro-profile hole  
escutcheon

## R 5155

**Bocchetta stretta**  
Narrow Escutcheon



**Materiale Acciaio Inox AISI 316 L**  
Material Stainless Steel AISI 316 L

**Finiture / Finishes**  
Satinato  
Lucido

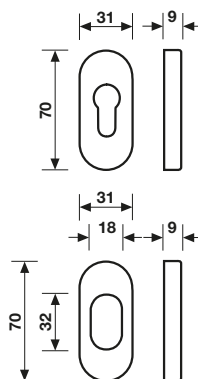

**R 5155 Y OV**  
Foro chiave normale  
Standard hole  
escutcheon

**R 5155 CO OV**  
Foro chiave cilindro  
Euro-profile hole  
escutcheon

## R 5145

**Bocchetta stretta**  
Narrow Escutcheon



**Materiale Acciaio Inox AISI 316 L**  
Material Stainless Steel AISI 316 L

**Finiture / Finishes**  
Satinato  
Lucido

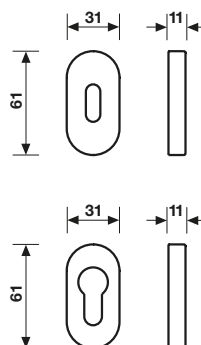

**R 5145 N**  
Foro chiave normale  
Standard hole  
escutcheon

**R 5145 Y**  
Foro chiave cilindro  
Euro-profile hole  
escutcheon

**Maniglia per porta**  
Door handle

**Materiale Acciaio Inox AISI 316 L**  
Material Stainless Steel AISI 316 L

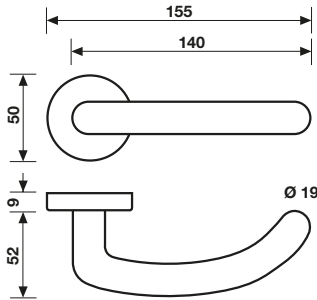

**Finiture**

Finishes

-  Satinato
-  Lucido

**H 5001 FRS-41**

**Maniglia per finestra**  
Window handle

**Movimento**  
**4 scatti**  
Movement  
4 click positions

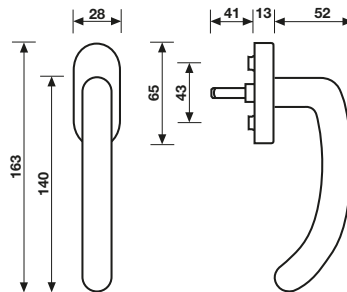

**H 5001 R8**

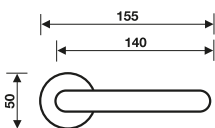

**H 5001 RG9 AS**  
**H 5001 RG8**  
**H 5001 RG8,5**

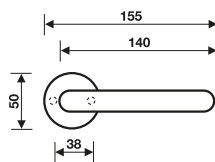

**H 5001 R09 AS**  
**H 5001 R08 AS**

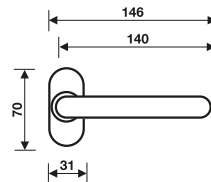

**H 5001 RP Passage**

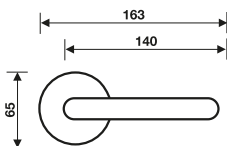

**H 5001 RP Privacy**

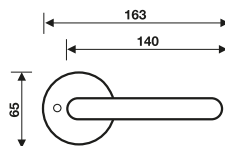

# H 5001

Serie **Cervino**  
design Fusital Workshop

## R 5154

**Bocchetta**  
Escutcheon



**Materiale Acciaio Inox AISI 316 L**  
Material Stainless Steel AISI 316 L

**Finiture / Finishes**  
Satinato  
Lucido

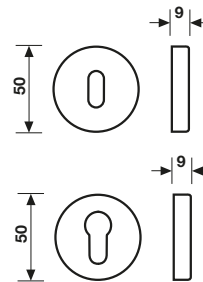

**R 5154 RN**  
Foro chiave normale  
Standard hole  
escutcheon

**R 5154 RY**  
Foro chiave cilindro  
Euro-profile hole  
escutcheon

## R 5154 RG

**Bocchetta stretta per RG8**  
Narrow Escutcheon for RG8



**Materiale Acciaio Inox AISI 316 L**  
Material Stainless Steel AISI 316 L

**Finiture / Finishes**  
Satinato  
Lucido

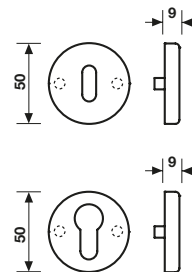

**R 5154 RGN**  
Foro chiave normale  
Standard hole  
escutcheon

**R 5154 RGY**  
Foro chiave cilindro  
Euro-profile hole  
escutcheon

## R 5155

**Bocchetta stretta**  
Narrow Escutcheon



**Materiale Acciaio Inox AISI 316 L**  
Material Stainless Steel AISI 316 L

**Finiture / Finishes**  
Satinato  
Lucido

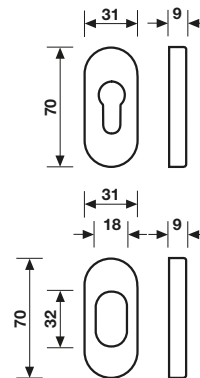

**R 5155 Y OV**  
Foro chiave normale  
Standard hole  
escutcheon

**R 5155 CO OV**  
Foro chiave cilindro  
Euro-profile hole  
escutcheon

## R 5145

**Bocchetta stretta**  
Narrow Escutcheon



**Materiale Acciaio Inox AISI 316 L**  
Material Stainless Steel AISI 316 L

**Finiture / Finishes**  
Satinato  
Lucido

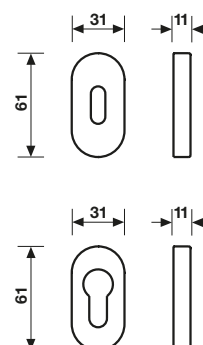

**R 5145 N**  
Foro chiave normale  
Standard hole  
escutcheon

**R 5145 Y**  
Foro chiave cilindro  
Euro-profile hole  
escutcheon

## S 5501 R

**Materiale Acciaio Inox AISI 316 L**  
Material Stainless Steel AISI 316 L

**Finiture / Finishes**  
Satinato  
Lucido

**Chiusura privacy BZG**  
Bathroom privacy set

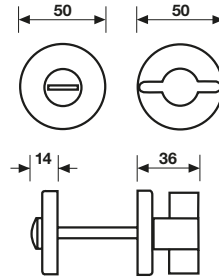

**S 5501 R6-7-8 BZG**



## S 5501 RS

**Materiale Acciaio Inox AISI 316 L**  
Material Stainless Steel AISI 316 L

**Finiture / Finishes**  
Satinato  
Lucido

**Chiusura privacy BZG**  
Bathroom privacy set

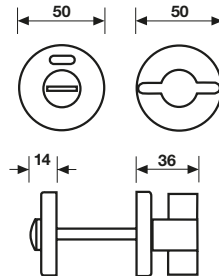

**S 5501 RS6-7-8 BZG**



## S 5501 RG

**Materiale Acciaio Inox AISI 316 L**  
Material Stainless Steel AISI 316 L

**Finiture / Finishes**  
Satinato  
Lucido

**Chiusura privacy BZG per RG8**  
Bathroom privacy set for RG8

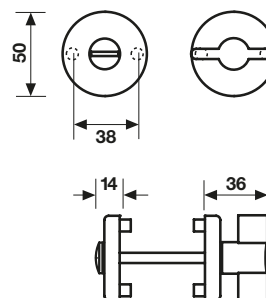

**S 5501 RG6-7-8 BZG**





**Informazioni tecniche**  
Technical informations



## X 0608

**Materiale Acciaio Inox**  
Material Stainless Steel

**Finiture / Finishes**  
Zincato

**Movimento**  
**8 scatti**  
Movement  
8 click positions

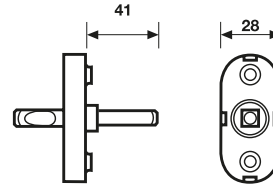

## X 0602

**Materiale Acciaio Inox**  
Material Stainless Steel

**Finiture / Finishes**  
Zincato

**Movimento**  
**4 scatti**  
Movement  
4 click positions

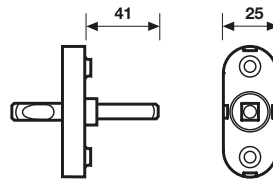

## X 0601

**Materiale Acciaio Inox**  
Material Stainless Steel

**Finiture / Finishes**  
Zincato

**Movimento**  
**4 scatti**  
Movement  
4 click positions

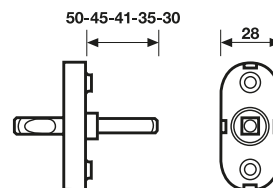

## X 0519 SPEC

**Per fissaggio pomolo fisso su serratura in coppia con maniglia.**

**Utilizzo di quadro solidale a piastrina**  
For fixing a fixed knob with operating lever on taylor spindle

per art.  
**K 5304**  
**K 5302**  
**K 5301**

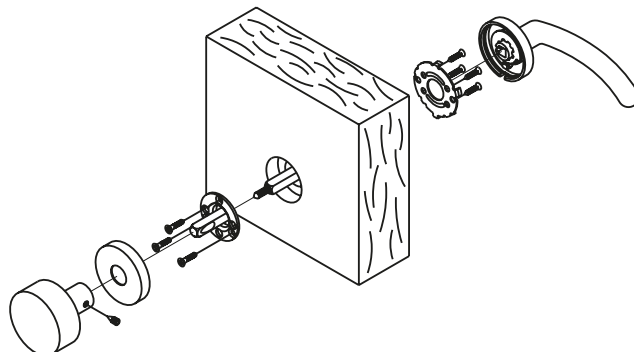

---

## X 0516

**Per fissaggio pomolo fisso singolo su porte in massello con bussola ad espansione in ottone.**

For fixing a single fixed knob on hardwood door using a brass anchor screw

per art.  
**K 377**  
**K 376**  
**K 375**  
**K 374**

**Diametro di foratura consigliato:**  
Recommended hole diameter: **Ø 10,2 mm**

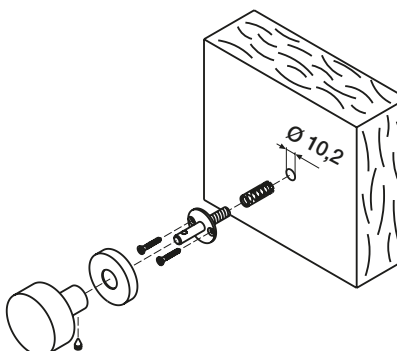

---

## X 0514

**Per fissaggio pomolo fisso su serratura in coppia con maniglia.**

**Utilizzo di quadro solidale a piastrina**  
For fixing a fixed knob with operating lever on taylor spindle

per art.  
**K 377**  
**K 376**  
**K 375**  
**K 374**

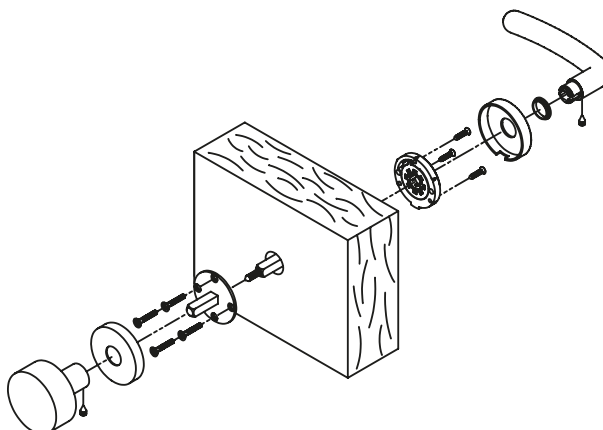

## X 0513

**Per fissaggio pomolo fisso singolo su porte con quadro solidale alla piastrina e viti a legno**

For fixing a single fixed knob on doors with taylor spindle and wood screws

per art.

K 378

K 377

K 376

K 375

K 374

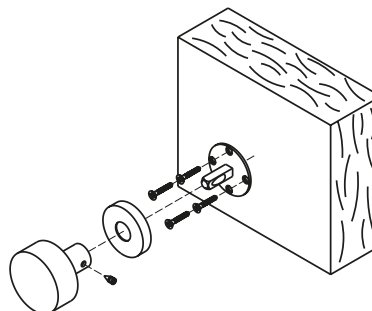

## X 0512

**Per fissaggio pomoli fissi in coppia su vetro spessore 8÷12 mm e su legno spessore 35÷43 mm**

For fixing a pair of fixed knobs on glass, thickness 8÷12 mm and on wood, thickness 35÷43 mm

per art.

K 378

K 377

K 376

K 375

K 374

**Diametro di foratura consigliato:**

Recommended hole diameter:  $\varnothing 5,5$  mm

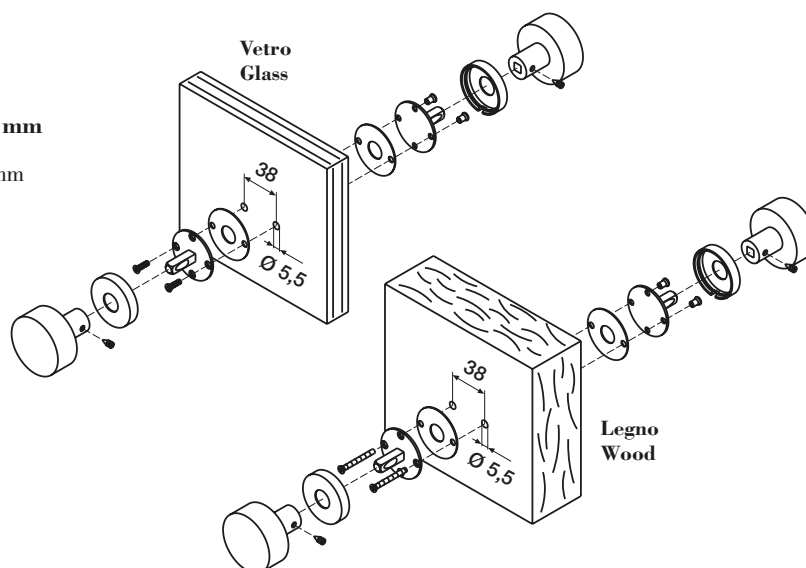

## X 0511

**Per fissaggio pomolo fisso senza foro passante**

For fixing a fixed knob without through screw

per art.

K 5304

K 5302

K 5301

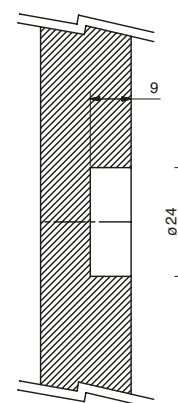
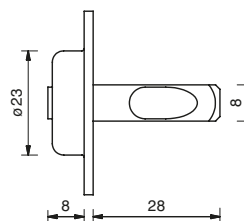
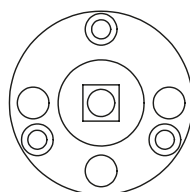

## X 0551

**Per fissaggio singolo maniglione senza rosette coprivite su porta in alluminio, per art.**  
For fixing a single pull handle without screw-covering rosettes on an aluminium door, for art.

**K 378 - K 377 - K 375 - K 368**  
**K 359 - K 358**  
**K 356 (Rosette da smontare prima del fissaggio)**  
(Before installation roses must be removed)

**Diametro di foratura consigliato:**  
Recommended hole diameter: **Ø 13 mm**

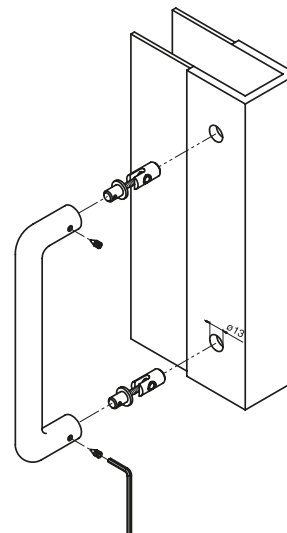

## X 0544

**Per fissaggio singolo maniglione senza rosette coprivite su porta blindata antieffrazione per art.**  
For fixing a single pull handle without rosettes on a burglary-proof steel-clad door, for art.

**K 378 - K 377 - K 375 - K 368**  
**K 359 - K 358**  
**K 356 (Rosette da smontare prima del fissaggio)**  
(Before installation roses must be removed)

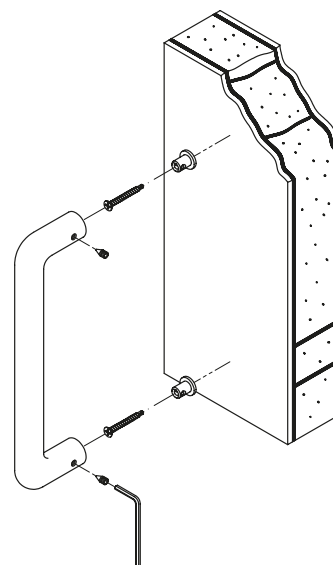

## X 0531

**Per fissaggio singolo maniglione senza rosette coprivite su porta legno o parete in muratura con bussola ad espansione in ottone per art.**  
For fixing a single pull handle without rosettes on a wooden door or on a masonry wall using a brass anchor screw for art.

**K 378 - K 377 - K 375 - K 368**  
**K 359 - K 358**  
**K 356 (Rosette da smontare prima del fissaggio)**  
(Before installation roses must be removed)

**Diametro di foratura consigliato:**  
Recommended hole diameter: **Ø 8.2 mm**

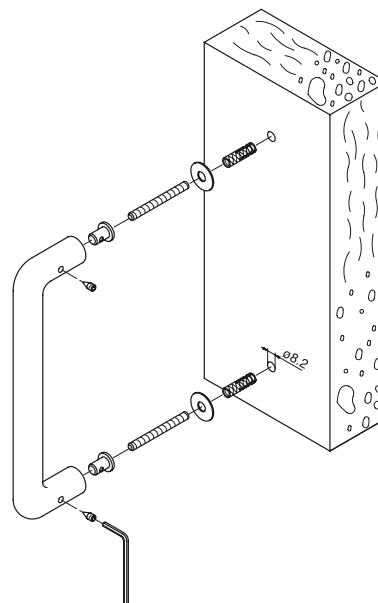

## X 0530

**Per fissaggio singolo maniglione senza rosette coprivite su porta legno spessori:**

For fixing a single pull handle without rosettes on a wooden door, thickness

45÷55 mm

55÷65 mm

**su porta vetro spessore:**

on a glass door, thickness: 8÷12 mm

per art.

K 378 - K 377 - K 375 - K 368

K 359 - K 358

K 356 (Rosette da smontare prima del fissaggio)  
(Before installation roses must be removed)

**Diametro di foratura consigliato**

Recommended hole diameter:

porta legno/wooden door: Ø 6.5 mm

porta vetro/glass door: Ø 9 mm

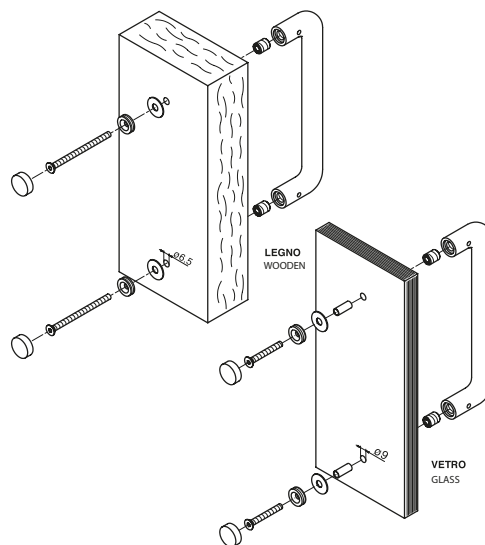

## X 0528

**Per fissaggio coppia maniglioni senza rosette coprivite su porta legno spessori:**

For fixing a pair of pull handles without screw-covering rosettes on a wooden door, thickness:

45÷55 mm

55÷65 mm

**su porta vetro spessore:**

on a glass door, thickness: 8÷12 mm

per art.

K 378 - K 377 - K 375 - K 368

K 359 - K 358

K 356 (Rosette da smontare prima del fissaggio)  
(Before installation roses must be removed)

**Diametro di foratura consigliato**

Recommended hole diameter:

porta legno/wooden door: Ø 6.5 mm

porta vetro/glass door: Ø 9 mm

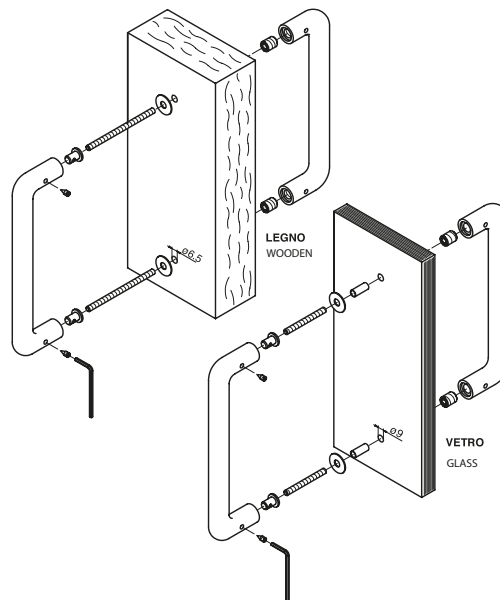

## X 0526

**Per fissaggio singolo maniglione con rosette coprivite su porta legno o parete in muratura con bussola ad espansione in ottone**

For fixing a single pull handle with screw-covering rosettes on wooden door or on a masonry wall using a brass anchor screw

per art.

K 378 - K 377 - K 375 - K 368 - K 356

K 352 DX/SX

**Diametro di foratura consigliato:**

Recommended hole diameter: Ø 8.2 mm

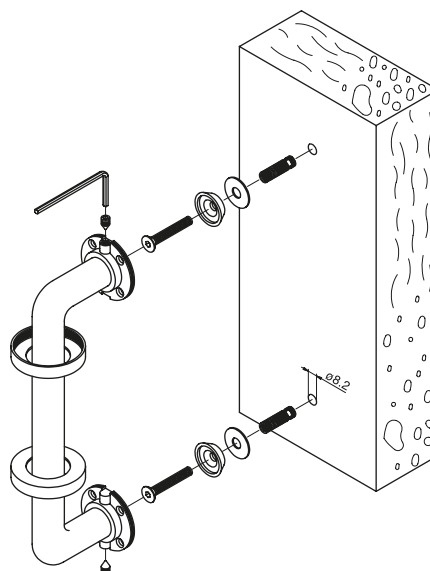

## X 0525

**Per fissaggio singolo maniglione con rosette coprivite su porta legno spessori:**

For fixing a single pull handle with rosettes on a wooden door, thickness

45÷55 mm

55÷65 mm

**su porta vetro spessore:**

on a glass door, thickness: 8÷12 mm

per art.

K 378 - K 377 - K 375 - K 368 - K 356

K 352 DX/SX

**Diametro di foratura consigliato**

Recommended hole diameter:

porta legno/wooden door: Ø 6.5 mm

porta vetro/glass door: Ø 9 mm

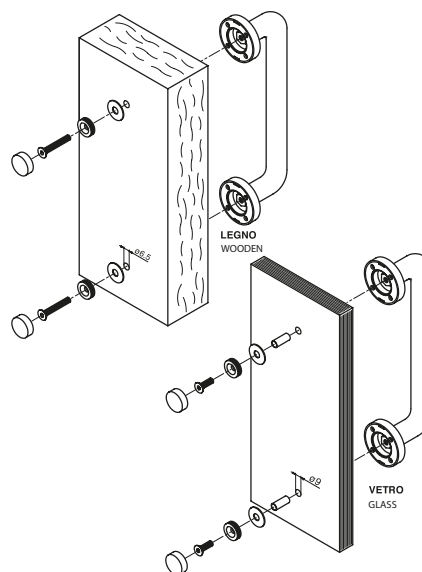

## X 0523

**Per fissaggio coppia maniglioni con rosette coprivite su**

**porta legno spessori:**

For fixing a pair of pull handles with screw-covering rosettes on a wooden door, thickness

45÷55 mm

55÷65 mm

**su porta vetro spessore:**

on a glass door, thickness: 8÷12 mm

per art.

K 378 - K 377 - K 375 - K 368 - K 356

K 352 DX/SX

**Diametro di foratura consigliato**

Recommended hole diameter:

porta legno/wooden door: Ø 6.5 mm

porta vetro/glass door: Ø 9 mm

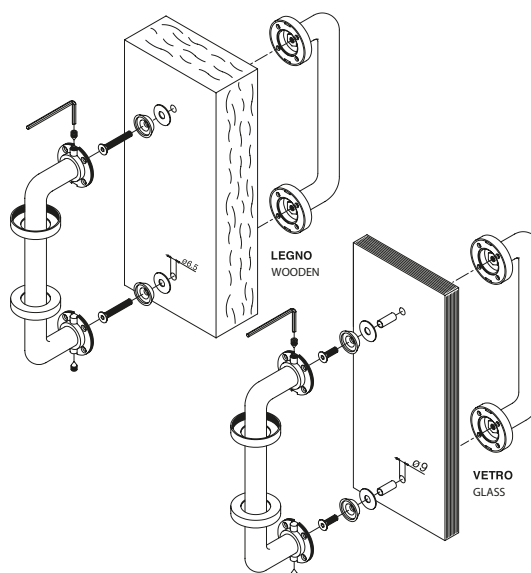

## X 0552

**Per fissaggio singolo maniglione senza**

**rosette coprivite su porta in alluminio, per art.**

For fixing a single pull handle without

screw-covering rosettes on an aluminium door, for art.

K 354 S - K 353 S

P5408 S 25 - P5407 S

P5406 S 25 - P5413 S

P5405 S 25

**Diametro di foratura consigliato:**

Recommended hole diameter: Ø 13 mm

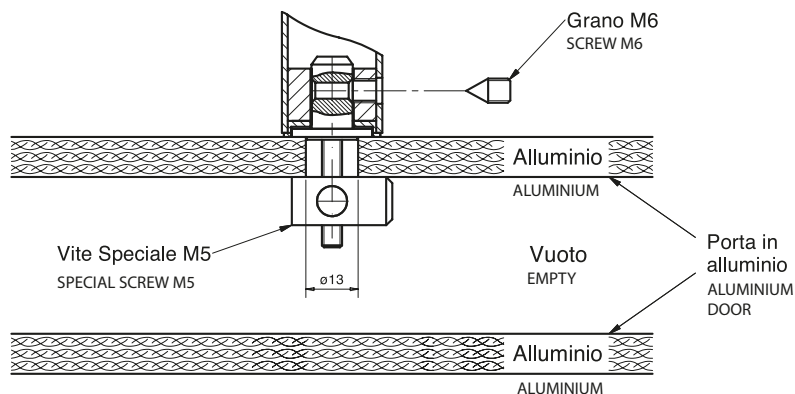

## X 0544 / 1

### Per fissaggio singolo maniglione senza rosette coprivite

in porta blindata antieffrazione per art.  
 For fixing a single pull handle without rosettes on a  
 burglary-proof steel-clad door, for art.

**K 354 S - K 353 S**  
**P 5413 S - P 5408 S 25**  
**P 5407 S - P 5406 S 25**  
**P 5405 S 25**

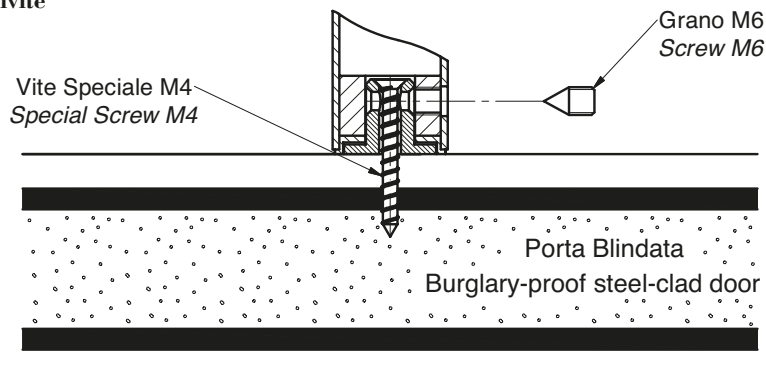

## X 0510

### Per fissaggio singolo maniglione su porta legno o parete

in muratura con bussola ad espansione in ottone  
 For fixing a single pull handle on a wooden door or on a  
 masonry wall using a brass anchor screw

per art.  
**K 354 S - K 353 S**  
**P5408 S 25 - P 5407 S**  
**P5406 S 25 - P 5413 S**  
**P5405 S 25**

### Per fissaggio coppia maniglioni su porta vetro spessore: 8÷12 mm

For fixing a pair of pull handle  
 on a glass door, thickness: 8÷12 mm

per art.  
**K 354 - K 353**  
**P5408 25 - P 5407**  
**P5406 25 - P 5413**  
**P5405 25**

### Diametro di foratura consigliato:

Recommended hole diameter:  
**porta legno/wooden door: Ø 10.2 mm**  
**porta vetro/glass door: Ø 11 mm**

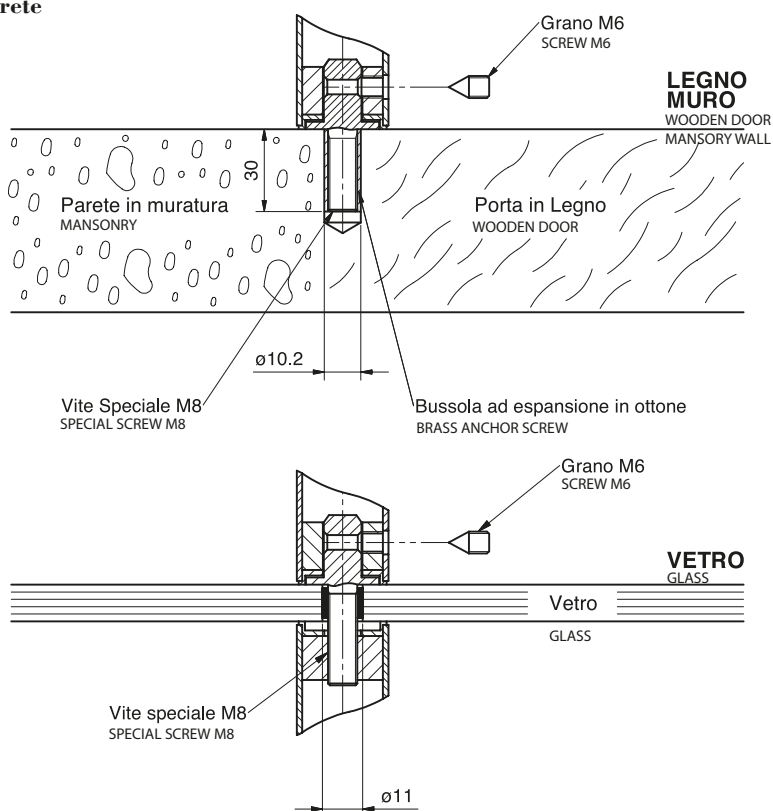

## X 0509

**Per fissaggio coppia maniglioni su porta legno**

**spessori:**

For fixing a pair pull handle on a wooden door thickness:

45÷60 mm

60÷75 mm

75÷90 mm

**per art.**

K 354 - K 353

P5408 25 - P 5407

P5406 25 - P 5413

P5405 25

**Diametro di foratura consigliato:**

Recommended hole diameter:

Ø 9 mm

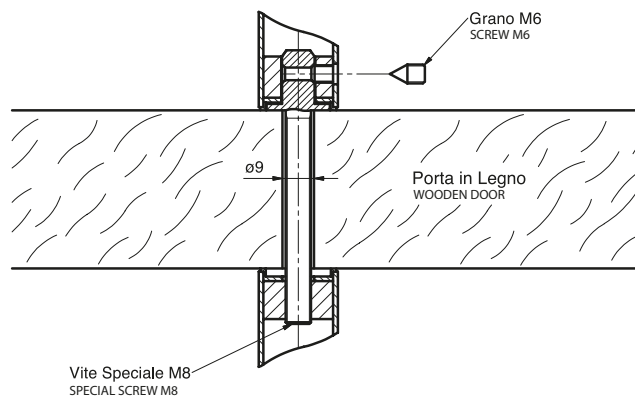

## X 0508

**Per fissaggio singolo maniglione su porta legno spessori:**

For fixing a single pull handle on a wooden door thickness:

45÷60 mm

60÷75 mm

75÷90 mm

**su porta vetro spessori: 8÷12 mm**

on a glass door, thickness: 8÷12 mm

**per art.**

K 354 - K 353

P5408 25 - P 5407

P5406 25 - P 5413

P5405 25

**Diametro di foratura consigliato:**

Recommended hole diameter:

**porta legno/wooden door: Ø 9 mm**

**porta vetro/glass door: Ø 11 mm**

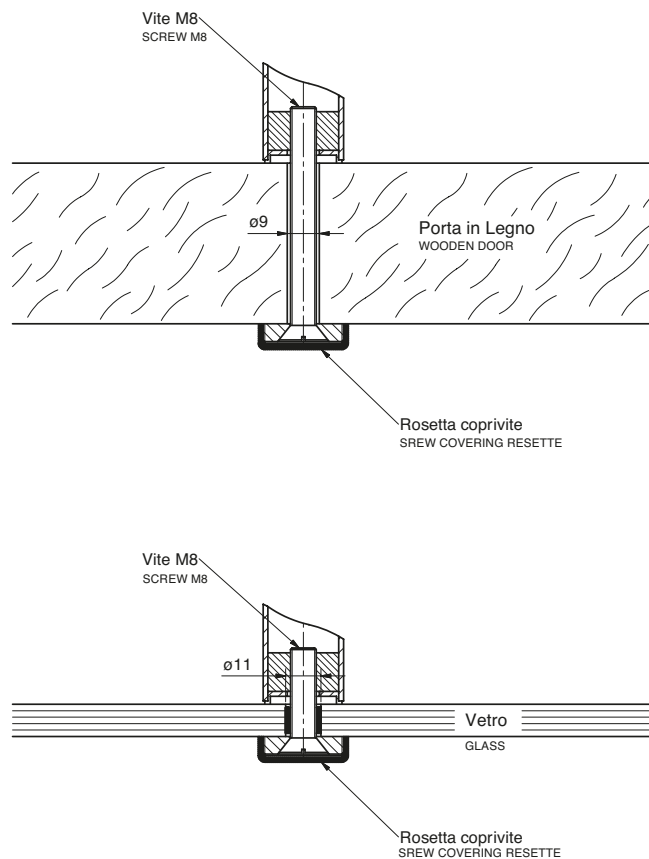



## X 0468/1 DX

**Sottorosetta con molla monodirezionale destra, diametro 50 mm, completa di viti per il fissaggio e bussola di centratura**

Anchor rosette, with right directional spring, diameter 50 mm, complete of fixing screws and centering bush

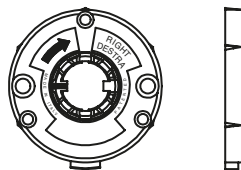

## X 0468/2 SX

**Sottorosetta con molla monodirezionale sinistra, diametro 50 mm, completa di viti per il fissaggio e bussola di centratura**

Anchor rosette, with left directional spring, diameter 50 mm, complete of fixing screws and centering bush

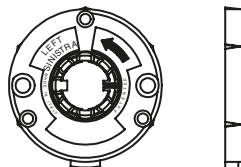

## X 0445/1 DX

**Sottorosetta con molla monodirezionale destra, diametro 45 mm, completa di viti per il fissaggio e bussola di centratura**

Anchor rosette, with right directional spring, diameter 45 mm, complete of fixing screws and centering bush

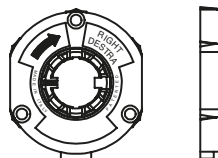

## X 0445/2 SX

**Sottorosetta con molla monodirezionale sinistra, diametro 45 mm, completa di viti per il fissaggio e bussola di centratura**

Anchor rosette, with left directional spring, diameter 45 mm, complete of fixing screws and centering bush

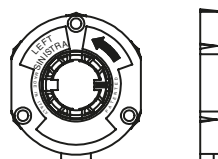

## X 0120/8

**Quadro block per porte forate solo da un lato**  
 Block spindle for doors drilled on one side only  
 $\varnothing 8$

**Materiale Acciaio Inox**  
 Material Stainless Steel

**Finiture / Finishes**  
 Zincato

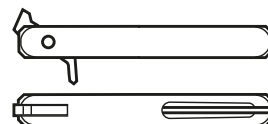
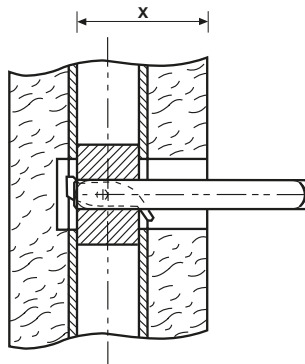

## X 0110/8

**Quadro con filetto per abbinamento maniglia-pomolo fisso**  
 Threaded spindle for handle/fixed knob combination  
 $\varnothing 8$

**Materiale Acciaio Inox**  
 Material Stainless Steel

**Finiture / Finishes**  
 Zincato

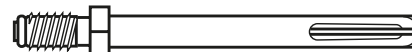
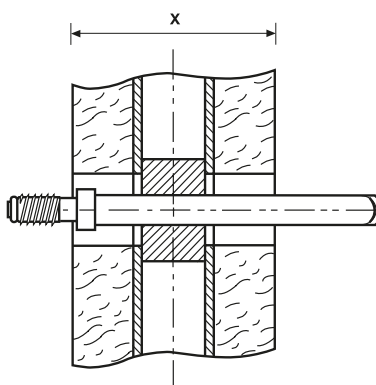

## X 0104

**Quadro tagliato**  
 Slotted spindle  
 $\varnothing 7$

**Materiale Acciaio Inox**  
 Material Stainless Steel

**Finiture / Finishes**  
 Zincato

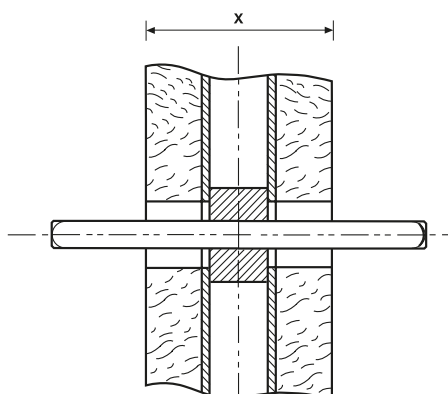

## X 0100/8

**Quadro tagliato**  
Slotted spindle  
∅ 8

**Materiale Acciaio Inox**  
Material Stainless Steel

**Finiture / Finishes**  
Zincato

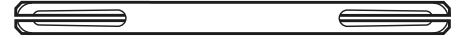
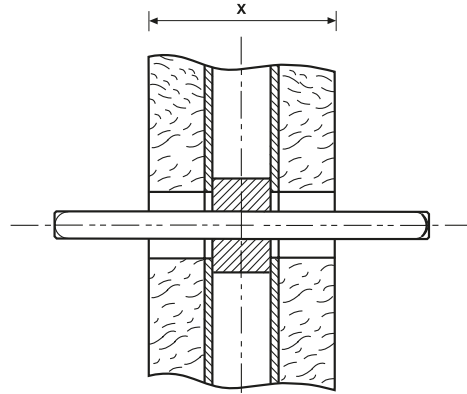

## X 0100/8,5

**Quadro tagliato**  
Slotted spindle  
∅ 8,5

**Materiale Acciaio Inox**  
Material Stainless Steel

**Finiture / Finishes**  
Zincato

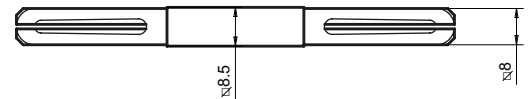
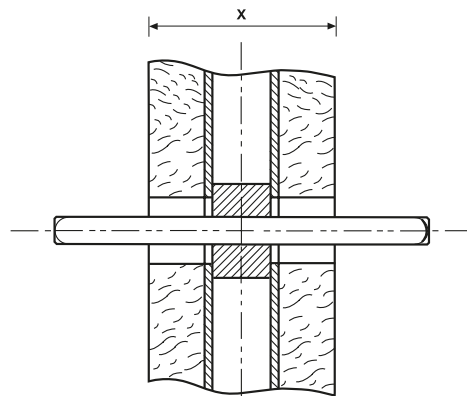

## X 4002

**Kit componenti per coppia di maniglie da montare su porta con serratura quadro 7 mm**  
Handle pair kit for door with lockset spindle 7 mm

**Materiale Acciaio Inox**  
Material Stainless Steel

**Finiture / Finishes**  
Zincato

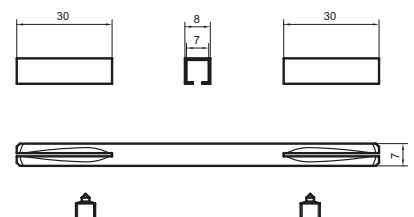
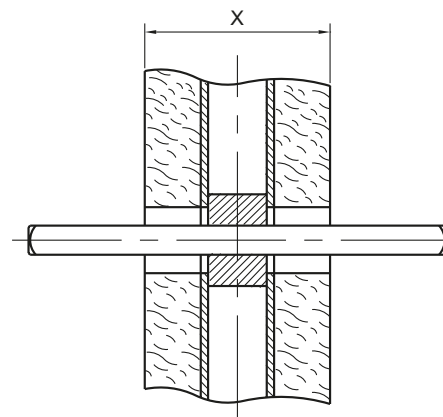



**Informazioni tecniche speciali**  
Special technical specifications

Passage Function  
RS trim

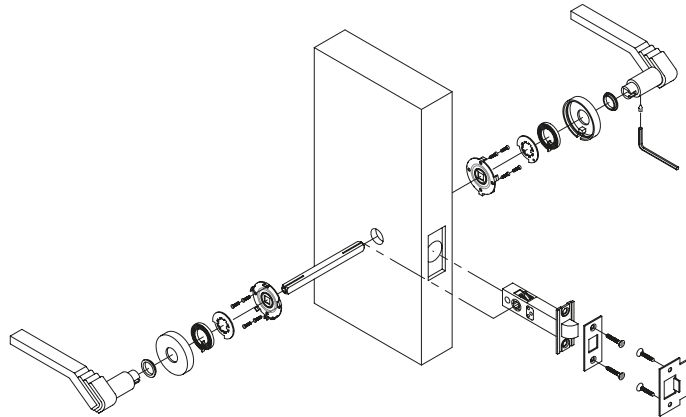

Privacy Function  
NEP Trim

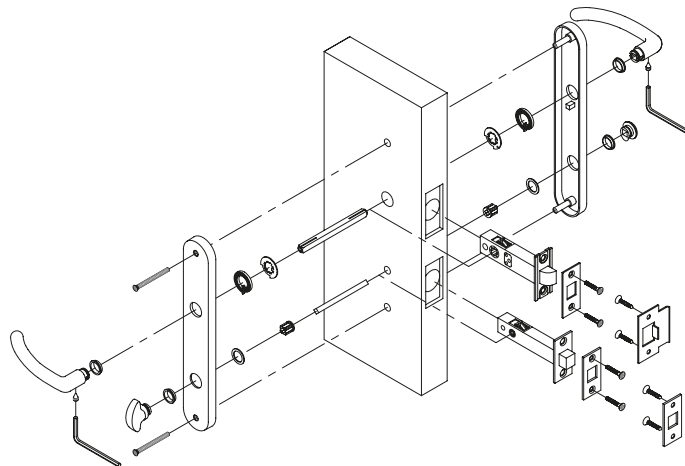

Privacy Function  
For long escutcheon plates  
EP trim

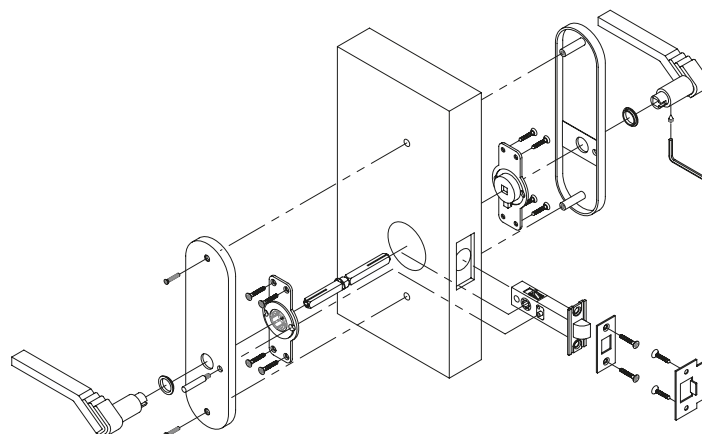

# Technical informations

## Interior sets

With round rosettes and long escutcheon plates

### Dummy Trim

For Rosette and Escutcheon

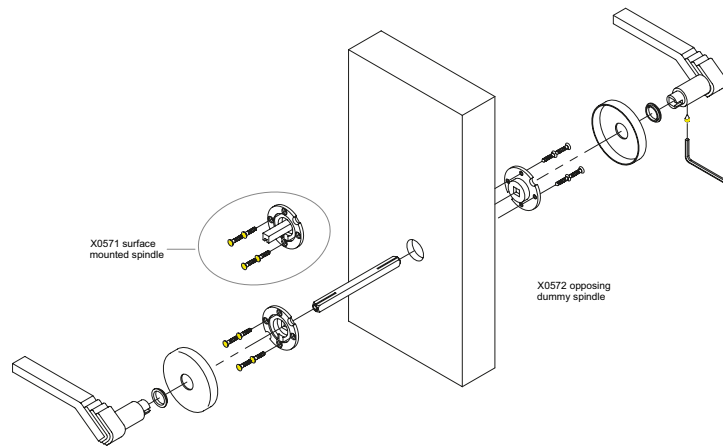

### Privacy Function

RQ trim

#### Parts List

1. Lever & Rosette Assemblies(2) includes:
  - a) lever
  - b) nylon washer
  - c) rosette
  - d) spring
  - e) retaining ring
2. Privacy Pin (1)
3. Through Screws (2)
4. Housing (1)
5. Two Piece Spindle (1)
6. Post Extensions (2) Rosette Stabilizers (2)
7. Latch (1)
8. Screw & Washer for Handing (1)
9. Face Plate (1)
10. Wood Screws (4)
11. Strike Plate (1)
12. Allen Wrench with 2 Set Screws (1)

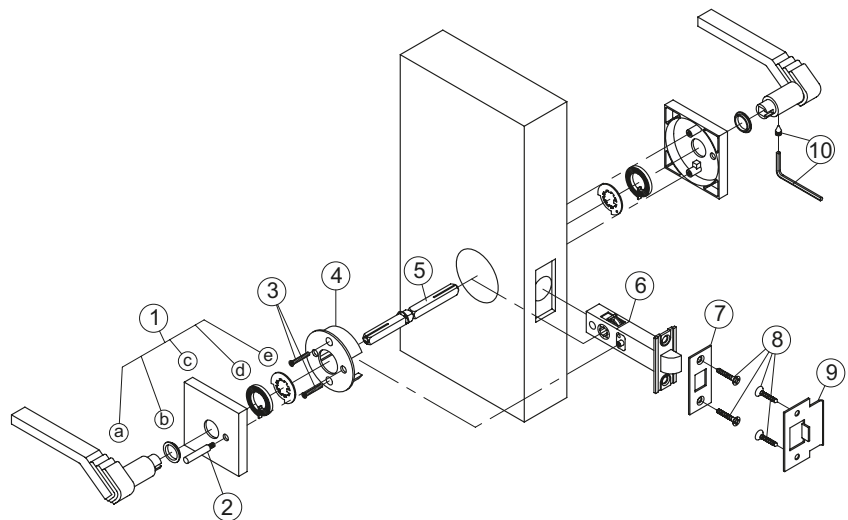

Double Cylinder  
102 RP trim

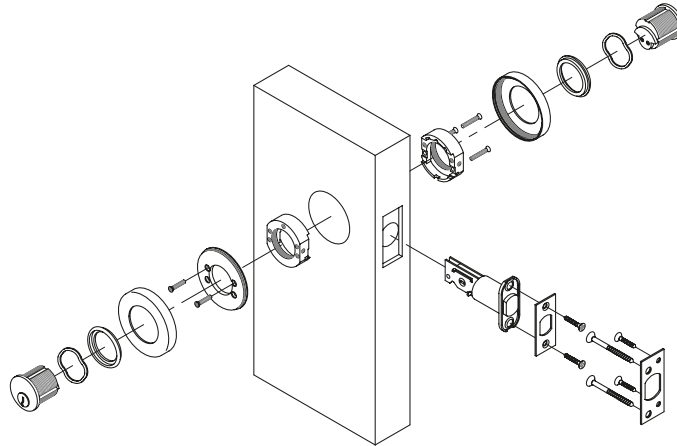

Privacy Bolt 105  
RSP trim

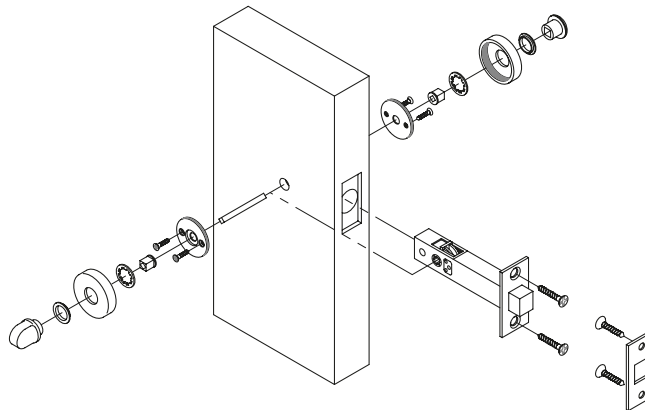

Escutcheon with deadbolt  
103 EP trim

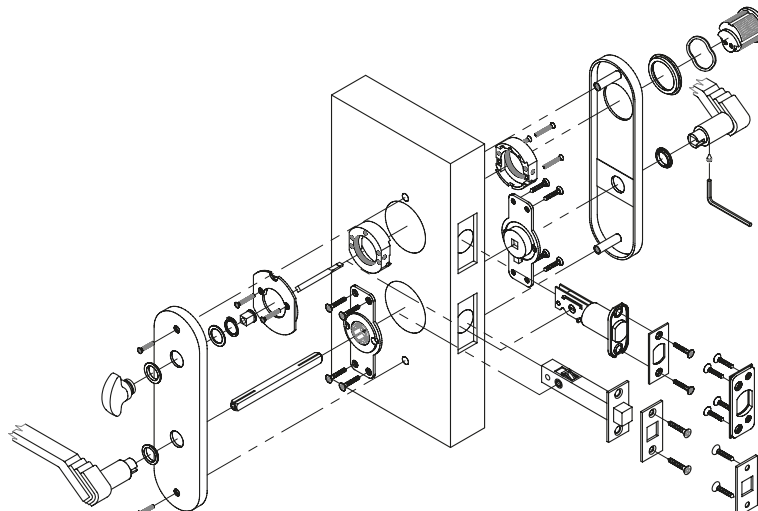

Single Cylinder deadbolt 101

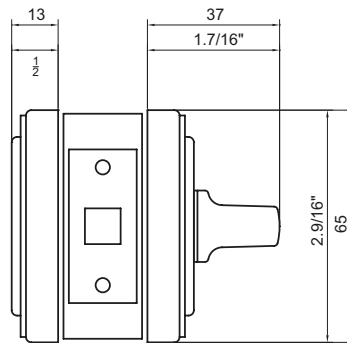

Model Single Cylinder deadbolt  
101 RQ trim

Parts List

1. Interior Rosette (1) includes:
  - a) thumbturn
  - b) nylon washer
  - c) rosette
  - d) metal washer
  - e) C-clip
  - f) nylon bushing
2. Under rosette (2)
3. 5/8" screws for under rosette (2)
4. Tailpiece (1)
5. Cylinder housing (1) includes 1.1/8" housing assembly screw
6. 1.1/8" cylinder housing screws (2)
7. Exterior rosette (1)
8. Cylinder collar (1)
9. Wave washer (1)
10. Cylinder with 2 keys (1)
11. Latch (1)
12. Face plate (1)
13. Strike plate (1)
14. Wood screws (6)
15. Allen wrench (not illustrated) (1)

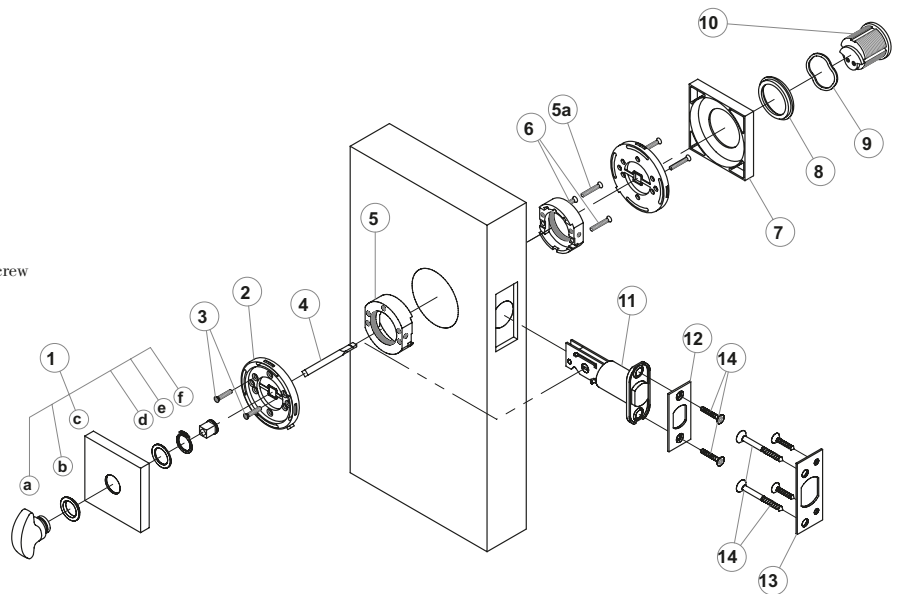



ML F RQ trim

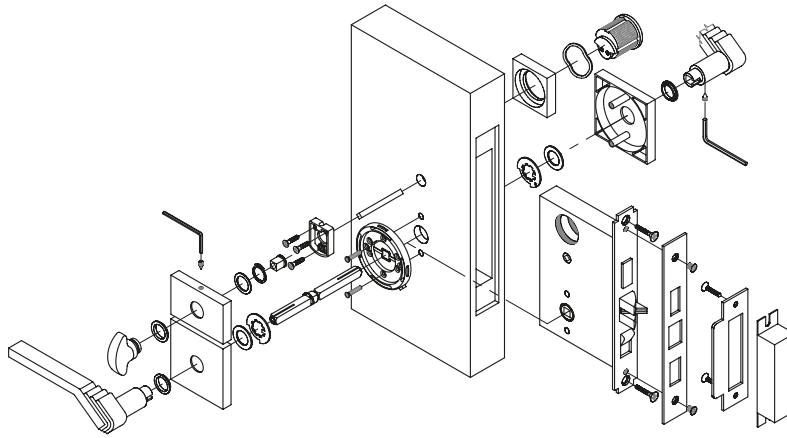

ML F RP trim

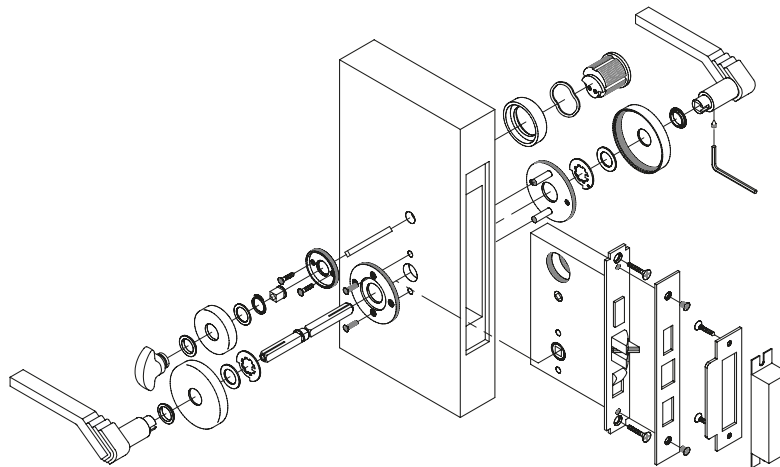

ML F ER trim

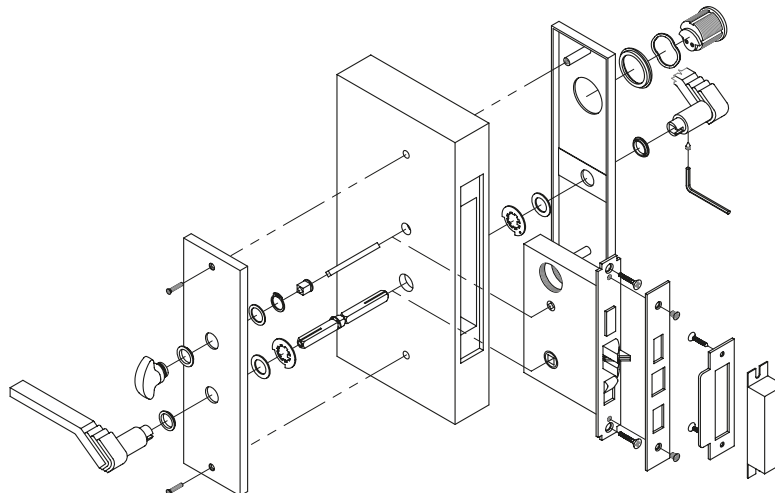

# Technical informations

## Stainless steel door hardware - Interior sets

Passage Function  
RSS trim

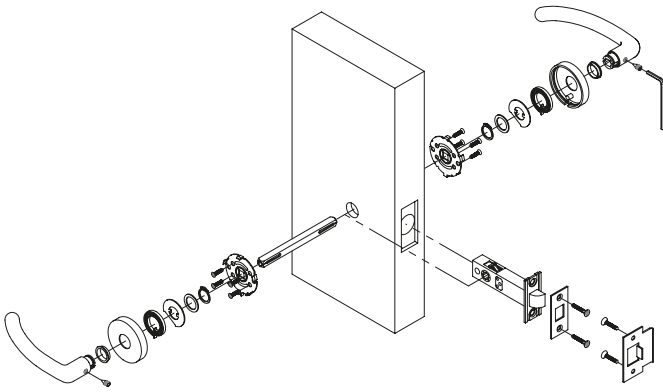

Privacy Function  
RQS trim

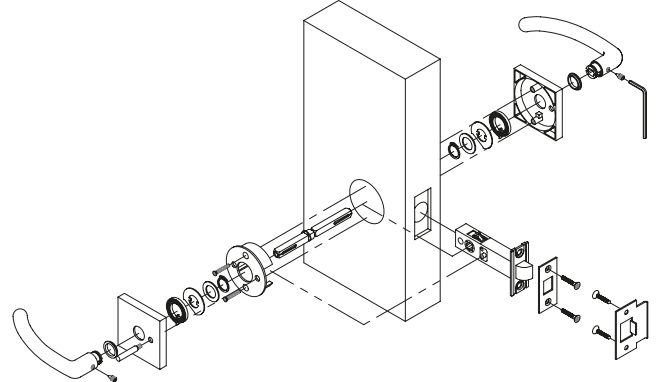

Privacy Function  
ERS trim

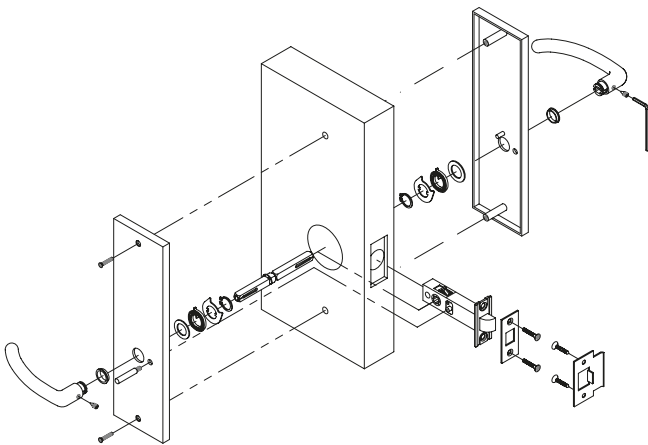

Privacy Function  
NES trim

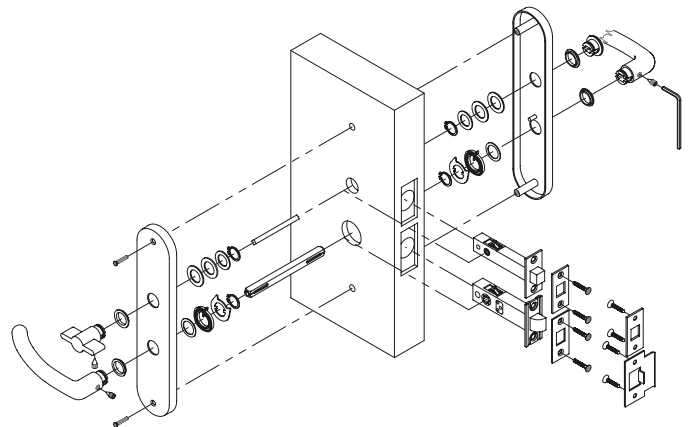

Dummy trim

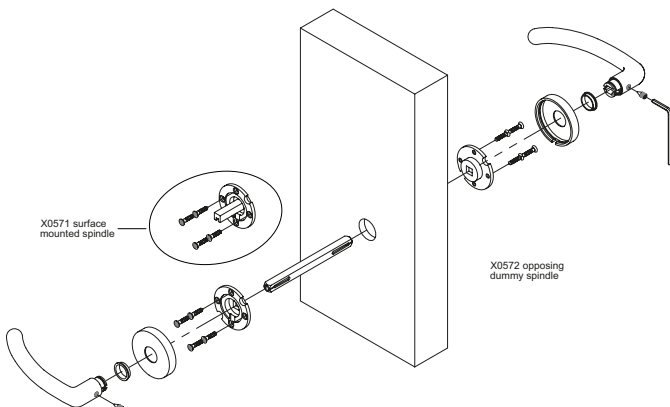

Privacy bolt  
105 RSQS

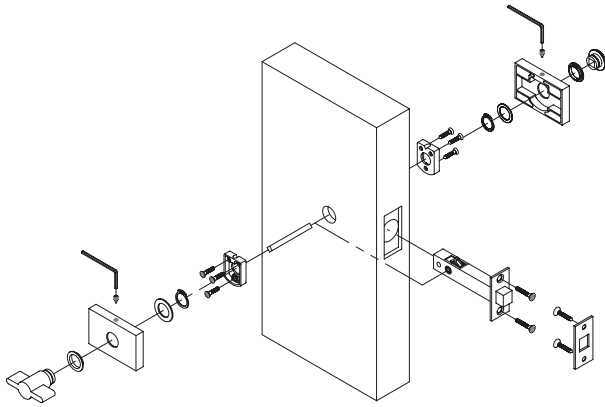

Deadbolt single cylinder  
101 RPS

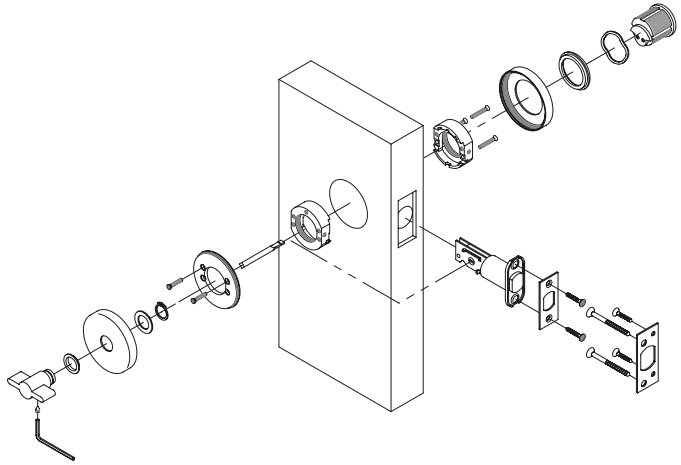

ML F  
ERS trim

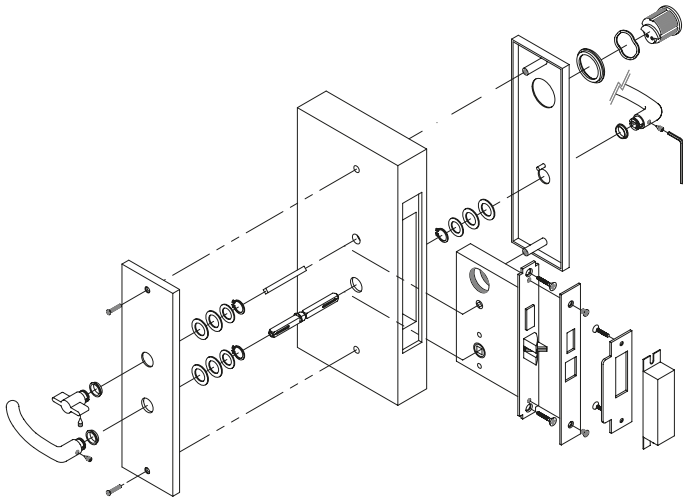

ML F  
RPS trim

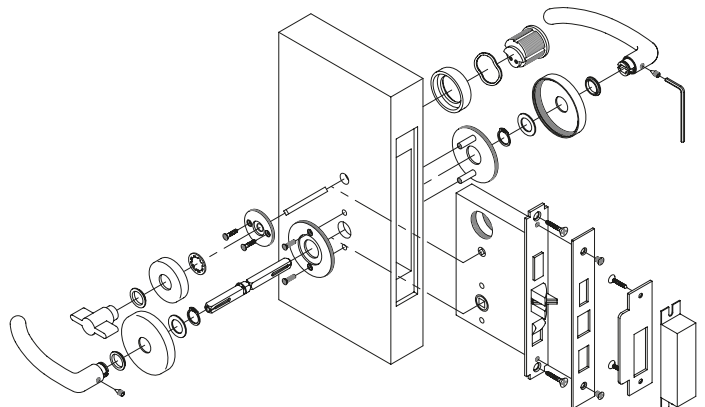

ML F  
NES trim

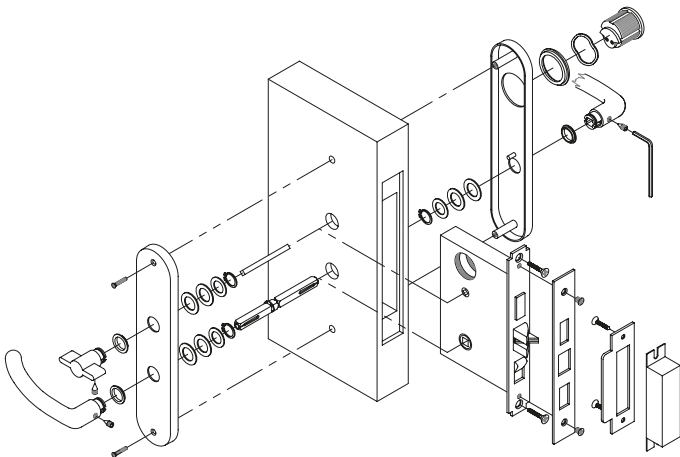



#### Ottone. Maniglie per porta

Brass. Door handles

Articolo Article	Serie Series	Spessore da Thickness from	a to	con quadro with spindle
H 378 R8	YP Duemiladiciotto	32 mm	63 mm	8 x 114 mm
H 377 R8	SL Duemilasedici	40 mm	60 mm	8 x 114 mm
H 376 R8	GV1 Duemilaquattordici	40 mm	60 mm	8 x 114 mm
H 375 R8	MT Duemilaquattordici	40 mm	60 mm	8 x 114 mm
H 374 R8	Compasso Duemilaquattordici	35 mm	45 mm	8 x 96 mm
H 373 R8	DOB Duemiladodici	40 mm	60 mm	8 x 114 mm
H 372 R8	EG Duemilaundici	38 mm	48 mm	8 x 104 mm
H 371 R8	LK Duemiladieci	30 mm	55 mm	8 x 114 mm
H 370 R8	MDF Duemiladieci	30 mm	55 mm	8 x 114 mm
H 369 R8	EG Duemilanove	40 mm	60 mm	8 x 114 mm
H 368 R8	CA Duemilanove	40 mm	60 mm	8 x 114 mm
H 367 R8	GV Duemilanove	40 mm	60 mm	8 x 114 mm
H 364 R8	MB Duemilanove	40 mm	60 mm	8 x 114 mm
H 363 R8	DC Duemilanove	40 mm	60 mm	8 x 114 mm
H 362 R8	CC Duemilanove	40 mm	60 mm	8 x 114 mm
H 361 R8	AC4 Duemilasei	40 mm	60 mm	8 x 114 mm
H 359 R8	SOM New York Duemilasette	30 mm	60 mm	8 x 114 mm
H 358 R8	JP1 Duemila	39 mm	50 mm	8 x 104 mm
H 356 R8	ZH Duemilacinque	33 mm	55 mm	8 x 114 mm
H 354 R8	FOG Duemilaquattro	40 mm	55 mm	8 x 114 mm
H 352 R8	ODBC Duemiladue	32 mm	56 mm	8 x 114 mm
H 350 R8	CA Duemiladue	33 mm	55 mm	8 x 114 mm
H 348 R8	DC Duemiladue	33 mm	55 mm	8 x 114 mm
H 344 R8	JN Duemilauno	33 mm	50 mm	8 x 104 mm
H 343 R8	JP Duemila	39 mm	50 mm	8 x 104 mm
H 341 R8	HK2 Duemila	33 mm	55 mm	8 x 114 mm
H 338 R8	YK Duemila	33 mm	55 mm	8 x 114 mm
H 335 R8	RM Novantotto	33 mm	43 mm	8 x 96 mm
H 334 R8	NF Novantotto	33 mm	55 mm	8 x 114 mm
H 332 R8	M Novantotto	33 mm	55 mm	8 x 114 mm
H 330 R8	T Novantasette	33 mm	55 mm	8 x 114 mm
H 329 R8	RB Novantacinque	33 mm	55 mm	8 x 114 mm
H 327 R8	AC 2 Novantacinque	33 mm	55 mm	8 x 114 mm
H 326 R8	AC 1 Novantacinque	33 mm	55 mm	8 x 114 mm
H 317 R8	AC Novantuno	33 mm	55 mm	8 x 114 mm
H 315 R8	G Novanta	33 mm	55 mm	8 x 114 mm
H 311 R8	Sei MB	30 mm	60 mm	8 x 114 mm
H 310 R8	Cinque C	37 mm	43 mm	8 x 96 mm
H 37 R8	Tre B	33 mm	55 mm	8 x 114 mm

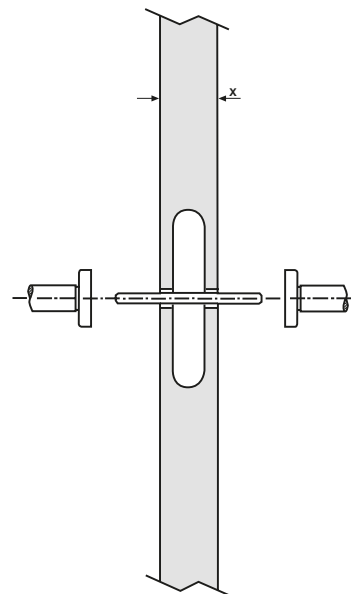

#### Chiusure privacy BZG / Bathroom privacy sets

Articolo Article	Serie Series	Spessore da Thickness from	a to	con quadro with spindle
K 3029 R6-7-8 BZG	MB	42 mm	52 mm	6 x 85 mm
K 3020 R6-7-8 BZG		42 mm	52 mm	6 x 85 mm
K 3013 R6-7-8 BZG		42 mm	52 mm	6 x 85 mm
K 397 RG6-7-8 BZG		42 mm	50 mm	6 x 85 mm
K 389 RG6-7-8 BZG		42 mm	50 mm	6 x 85 mm
K 382 R6-7-8 BZG		42 mm	52 mm	6 x 85 mm

#### Pomoli / Door knobs

Articolo Article	Serie Series	Spessore da Thickness from	a to	con quadro with spindle
K 378 R8	YP Duemiladiciotto	40 mm	60 mm	8 x 114 mm
K 377 R8	SL Duemilasedici	40 mm	60 mm	8 x 114 mm
K 376 R8	GV1 Duemilaquattordici	35 mm	45 mm	8 x 96 mm
K 375 R8	MT Duemilaquattordici	35 mm	45 mm	8 x 96 mm
K 374 R8	Compasso Duemilaquattordici	35 mm	45 mm	8 x 96 mm



Per gli articoli su rosetta fine, il quadro è 10 mm inferiore allo standard in elenco  
 Please be aware that for all handles on slim rose, the spindle length is 10 mm less than the one indicated for standard handles

Per spessori porta diversi da quelli corrispondenti all'articolo, utilizzare quadri di lunghezze diverse presenti nel listino.

For door thickness outside the range covered by the standard spindle, select the spindle of the required length from those shown in the price list.

## Elenco spessori porta per articolo

### List of door thicknesses for article

#### Inox. Maniglie per porta

Stainless steel. Door handles

Articolo Article	Serie Series	Spessore da Thickness from	a to	con quadro with spindle
H 5022 R8	Einser	35 mm	50 mm	8 x 114 mm
H 5021 R8	Arrowhead	35 mm	50 mm	8 x 114 mm
H 5017 R8	Gottardo	40 mm	60 mm	8 x 114 mm
H 5015 R8	K2	30 mm	60 mm	8 x 114 mm
H 5014 R8	Bernina	30 mm	60 mm	8 x 114 mm
H 5010 R8	Cresta	34 mm	50 mm	8 x 114 mm
H 5008 R8	Himalaya	34 mm	50 mm	8 x 114 mm
H 5005 R8	Amiata	34 mm	50 mm	8 x 114 mm
H 5001 R8	Cervino	34 mm	50 mm	8 x 114 mm

#### Chiusure privacy BZG

Bathroom privacy sets

Articolo Article	Serie Series	Spessore da Thickness from	a to	con quadro with spindle
S 5505 R6-7-8 BZG	Cresta	38 mm	44 mm	6 x 75 mm
S 5501 R6-7-8 BZG		38 mm	44 mm	6 x 75 mm

#### Pomoli

Door knobs

Articolo Article	Serie Series	Spessore da Thickness from	a to	con quadro with spindle
K 5304	Cresta	34 mm	50 mm	8 x 114 mm
K 5302		34 mm	50 mm	8 x 114 mm
K 5301		34 mm	50 mm	8 x 114 mm

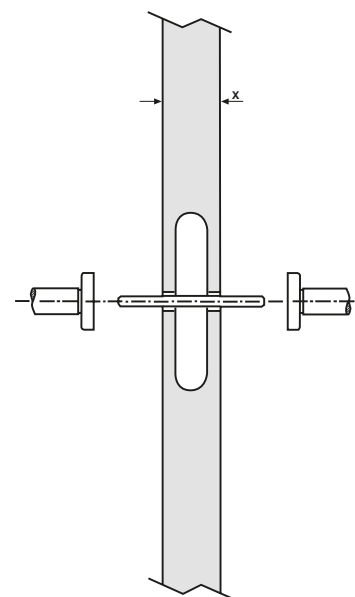







**ASSA ABLOY Italia S.p.A.**  
**Sede di Milano / Milan Unit**  
Via Concordia, 16  
20838 Renate (MB) - Italy  
www.assaabloy.it - www.vallievalli.com

**Ufficio Commerciale Italia**  
**Italian Business Office**  
Tel. +39 0362 982271  
Fax +39 0362 982235  
valli.italia@assaabloy.it

**Ufficio Commerciale Export**  
**Export Business Office**  
Tel. +39 0362 982260  
Fax +39 0362 982214  
valli.export@assaabloy.it

**VALLI&VALLI USA INC**  
22 WEST 21ST. STREET 6TH. FLOOR  
NEW YORK NY 10010  
Tel. +1 212 326 8811  
Fax +1 212 326 8816  
TOLL FREE: 877 326 2565  
TOLL FREE: 800 423 7161  
sales@vallivalli-us.com

**Asa Abloy si riserva il diritto di apportare eventuali modifiche atte a migliorare i prodotti, senza alcun preavviso.  
Le misure dei nostri prodotti indicate nel presente catalogo si intendono approssimative.**

Asa Abloy reserve the right to make modifications directed towards improving their products, without previous notice.  
The sizes of our products indicated in this catalogue are indicative.

ASSA ABLOY is the global leader in door opening solutions, dedicated to satisfying end-user needs for security, safety and convenience



ASSA ABLOY Italia S.p.A.

[www.assaabloy.it](http://www.assaabloy.it)  
[www.vallievalli.com](http://www.vallievalli.com)

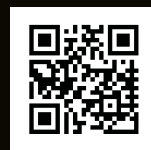

RIF. Z 3006 01/2018